

SHARP

Important



R-92A0(ST)V 1000 W (IEC 60705)

MICROWAVE OVEN WITH GRILL AND CONVECTION OPERATION MANUAL

This operation manual contains important information which you should read carefully before using your microwave oven.

IMPORTANT: There may be a serious risk to health if this operation manual is not followed or if the oven is modified so that it operates with the door open.

ENGLISH



CONTENTS

Operation manual

CONTENTS	2
SPECIFICATIONS	2
OVEN AND ACCESSORIES	3
CONTROL PANEL	4
IMPORTANT SAFETY INSTRUCTIONS	5-7
INSTALLATION	7
BEFORE OPERATION	8
SETTING THE CLOCK.....	8
KITCHEN TIMER FUNCTION	8
MICROWAVE POWER LEVELS	8
MANUAL OPERATION	9
MICROWAVE COOKING	9
GRILL COOKING / COMBI COOKING.....	9-10
CONVECTION COOKING.....	10-11
OTHER CONVENIENT FUNCTIONS	11
WEIGHT DEFROST AND TIME DEFROST FUNCTION	12
AUTO MENU OPERATION.....	12
AUTO MENU CHART.....	13
SUITABLE OVENWARE	14
CARE AND CLEANING	15
TROUBLESHOOTING.....	15-16



SPECIFICATIONS

Model name:	R-92A0(ST)V
AC Line Voltage	: 230-240V~, 50Hz single phase
Distribution line fuse/circuit breaker	: 20A
AC Power required: Microwave	: 1550W
Output power: Microwave	: 1000W
Top Grill (Infrared)	: 1100W
Convection	: 2100W
Off Mode (Energy Save Mode)	: less than 1.0W
Microwave Frequency	: 2450MHz
Outside Dimensions (W) x (H) x (D) mm	: 519 x 315 x 510
Cavity Dimensions (W) x (H) x (D) mm	: 351 x 249 x 361
Oven Capacity	: 32 litres***
Turntable (glass)	: ø 315mm
Weight	: approx. 18.5kg

AS PART OF A POLICY OF CONTINUOUS IMPROVEMENT, WE RESERVE THE RIGHT TO ALTER DESIGN AND SPECIFICATIONS WITHOUT NOTICE.

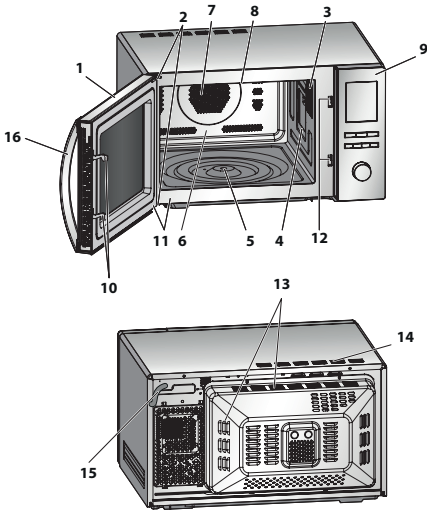

OVEN

1. Door
2. Door hinges
3. Oven lamp
4. Waveguide cover (DO NOT REMOVE)
5. Coupling
6. Oven cavity
7. Convection fan (covered)
8. Grill heating element (under the ceiling)
9. Control panel
10. Door latches
11. Door seals and sealing surfaces
12. Door safety latches
13. Ventilation openings
14. Outer cabinet
15. Power supply cord
16. Door handle

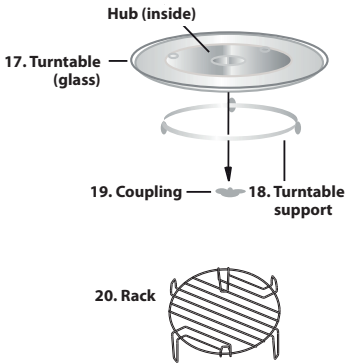

ACCESSORIES:

- Check to make sure the following accessories are provided: (17) Turntable (18) Turntable support (19) Coupling (20) Rack
- Place the turntable support in the centre of the oven floor so that it can freely rotate around the coupling. Then place the turntable on to the turntable support so that it locates firmly into the coupling.
 - To avoid turntable damage, ensure dishes and containers are lifted clear of the turntable rim when removing them from the oven.
 - For use of the rack, refer to the grilling sections on page GB-9-10.

Never touch the grill when it is hot.

NOTE: When you order accessories, please mention two items: part name and model name to your dealer or SHARP authorised service agent.

NOTES:

- The waveguide cover is fragile. Care should be taken when cleaning inside the oven to ensure that it is not damaged.
- After cooking fatty foods without a cover, always clean the cavity and especially the grill heating element thoroughly, these must be dry and free from grease. Built-up grease may overheat and begin to smoke or catch fire.
- Always operate the oven with the turntable and turntable support fitted correctly. This promotes thorough, even cooking. A badly fitted turntable may rattle, may not rotate properly and could cause damage to the oven.
- All food and containers of food are always placed on the turntable for cooking.
- The turntable rotates clockwise or anti-clockwise. The rotary direction may change each time you start the oven. This does not affect cooking performance.



WARNING:





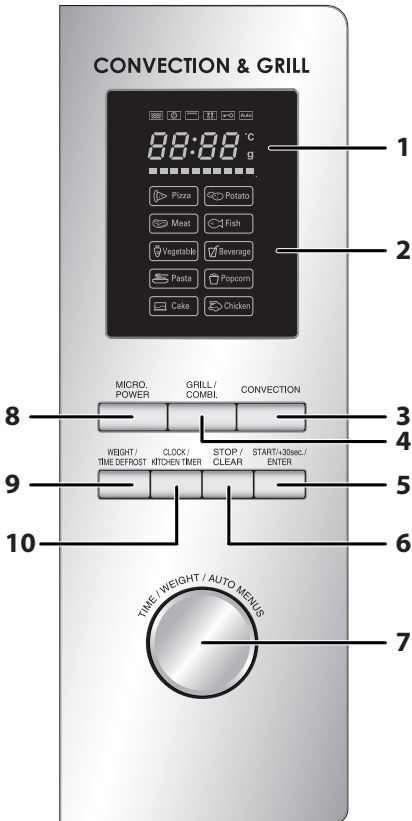

The door, outer cabinet, oven cavity, accessories and dishes will become very hot during operation. To prevent burns, always use thick oven gloves.



CONTROL PANEL



1. DIGITAL DISPLAY and INDICATORS

-  Heat indicator
-  **CONVECTION** indicator
-  **GRILL** indicator
-  **DEFROST** indicator
-  **CHILD LOCK** indicator
-  **AUTO MENU** indicator
- °C** TEMPERATURE indicator
- g** WEIGHT indicator

2. Auto Menu options:

Pizza
Potato
Meat
Fish
Vegetable
Beverage
Pasta
Popcorn
Cake
Chicken

3. CONVECTION button

4. GRILL/COMBI. button

5. START/+30sec./ENTER button

6. STOP/CLEAR button

7. ENTRY dial

Rotate to enter the cooking time, time, power level, temperature, weight and select auto menu



8. MICRO.POWER button:

Press to select microwave power level.

9. WEIGHT/TIME DEFROST button

10. CLOCK/KITCHEN TIMER button



1. This oven is designed to be used on a countertop only. It is not designed to be built into a kitchen unit. Do not place the oven in a cabinet.
 2. The oven door may become hot during cooking. Place or mount the oven so that the bottom of the oven is 85 cm or more above the floor. Keep children away from the door to prevent them burning themselves.
 3. Ensure there is a minimum of free space above the oven of 30 cm.
 4. This appliance is not intended for use by persons (including children) with reduced physical, sensory or mental capabilities, or lack of experience and knowledge, unless they have been given supervision or instruction concerning use of the appliance by a person responsible for their safety.
 5. Children should be supervised to ensure that they do not play with the appliance.
 6. **WARNING:** Only allow children to use the oven without supervision when adequate instructions have been given so that the child is able to use the oven in a safe way and understands the hazards of improper use.
 7. **WARNING:** When the appliance is operated in the GRILL/COMBI. and CONV.(°C) modes, children should only use the oven under adult supervision due to the temperature generated.
 8. **WARNING:** Accessible parts may become hot during use. Young children should be kept away.
 9. **WARNING:** If the door or door seals are damaged, the oven must not be operated until it has been repaired by a competent person.
 10. **WARNING:** Never adjust, repair or modify the oven yourself. It is hazardous for anyone other than a competent person to carry out any service or repair operation which involves the removal of a cover which gives protection against exposure to microwave energy.
 11. If the power supply cord of this appliance is damaged, it must be replaced with a special cord. The exchange must be made by an authorised SHARP service agent.
 12. **WARNING:** Liquids and other foods must not be heated in sealed containers since they are liable to explode.
 13. Microwave heating of beverages can result in delayed eruptive boiling, therefore care must be taken when handling the container.
 14. Do not cook eggs in their shells, and whole hard boiled eggs should not be heated in microwave ovens since they may explode even after microwave cooking has ended. To cook or reheat eggs which have not been scrambled or mixed, pierce the yolks and the whites, or the eggs may explode. Shell and slice hard boiled eggs before reheating them in the microwave oven.
 15. Utensils should be checked to ensure that they are suitable for use in the oven. See Page GB-14. Use only microwave safe containers and utensils on microwave modes.
 16. The contents of feeding bottles and baby food jars must be stirred or shaken and the temperature checked before consumption, in order to avoid burns.
 17. The door, outer cabinet, oven cavity, dishes, accessories and especially the grill heating elements will become very hot during operation.
 18. Care should be taken to avoid touching these areas. To prevent burns, always use thick oven gloves. Before cleaning make sure they are not hot. When heating food in plastic or paper containers, keep an eye on the oven due to the possibility of ignition.
 19. If smoke is observed, switch off or unplug the oven and keep the door closed in order to stifle any flames.
 20. Clean the oven at regular intervals and remove any food deposits.
 21. Failure to maintain the oven in a clean condition could lead to deterioration of the surface that could adversely affect the life of the appliance and possibly result in a hazardous situation.
 22. Do not use harsh abrasive cleaners or sharp metal scrapers to clean the glass on the oven door since they can scratch the surface, which may result in shattering of the glass.
 23. Steam cleaner is not to be used.
 24. See instructions for cleaning door seals, cavities and adjacent parts on page GB-15.
- To avoid the danger of fire.**
1. **The microwave oven should not be left unattended during operation. Power levels that are too high, or cooking times that are too long, may overheat foods resulting in a fire.**
 2. The electrical outlet must be readily accessible so that the unit can be unplugged easily in an emergency.
 3. The AC power supply must be 230-240V~, 50Hz, with a 20A distribution line fuse, or a 20A distribution circuit breaker.
 4. A separate circuit serving only this appliance should be provided.
 5. Do not place the oven in areas where heat is generated. For example, close to a conventional oven.
 6. Do not install the oven in an area of high humidity or where moisture may collect.
 7. Do not store or use the oven outdoors.
 8. Clean the waveguide cover, the oven cavity, the turntable and turntable support after use. These must be dry and free from grease. Built-up grease may overheat and begin to smoke or catch fire.
 9. Do not place flammable materials near the oven or ventilation openings.
 10. Do not block the ventilation openings.
 11. Remove all metallic seals, wire twists, etc., from food and food packages. Arcing on metallic surfaces may cause a fire.
 12. Do not use the microwave oven to heat oil for deep frying. The temperature cannot be controlled and the oil may catch fire.
 13. To make popcorn, use only special microwave popcorn makers.



IMPORTANT SAFETY INSTRUCTIONS

14. Do not store food or any other items inside the oven.
15. Check the settings after you start the oven to ensure the oven is operating as desired.
16. To avoid overheating and fire, special care must be taken when cooking or reheating foods with a high sugar or fat content, for example, sausage rolls, pies or Christmas pudding.
17. See the corresponding hints in operation manual.

To avoid the possibility of injury

1. WARNING:

Do not operate the oven if it is damaged or malfunctioning. Check the following before use:

- a) The door; make sure the door closes properly and ensure it is not misaligned or warped.
 - b) The hinges and safety door latches; check to make sure they are not broken or loose.
 - c) The door seals and sealing surfaces; ensure that they have not been damaged.
 - d) Inside the oven cavity or on the door; make sure there are no dents.
 - e) The power supply cord and plug; ensure that they are not damaged.
2. Do not operate the oven with the door open or alter the door safety latches in any way.
 3. Do not operate the oven if there is an object between the door seals and sealing surfaces.
 4. Do not allow grease or dirt to build up on the door seals and adjacent parts. Clean the oven at regular intervals and remove any food deposits. Follow the instructions for "Care and Cleaning" on page GB-15.
 5. Individuals with PACEMAKERS should check with their doctor or the manufacturer of the pacemaker for precautions regarding microwave ovens.

To avoid the possibility of electric shock

1. Under no circumstances should you remove the outer cabinet.
2. Never spill or insert any objects into the door lock openings or ventilation openings. In the event of a spill, turn off and unplug the oven immediately, and call an authorised SHARP service agent.
3. Do not immerse the power supply cord or plug in water or any other liquid.
4. Do not let the power supply cord hang over the edge of a table or work surface.
5. Keep the power supply cord away from heated surfaces, including the rear of the oven.
6. Do not attempt to replace the oven lamp yourself or allow anyone who is not an electrician authorised by SHARP to do so. If the oven lamp fails, please consult your dealer or an authorised SHARP service agent.

To avoid the possibility of explosion and sudden boiling:

1. Never use sealed containers. Remove seals and lids before use. Sealed containers can explode due to a build up of pressure even after the oven has been turned off.
2. Take care when microwaving liquids. Use a wide mouthed container to allow bubbles to escape.
Never heat liquids in narrow necked containers such as baby bottles, as this may result in the

contents erupting from the container when heated and cause burns.

To prevent sudden eruption of boiling liquid and possible scalding:

1. Do not use excessive amount of time
2. Stir liquid prior to heating/reheating.
3. It is advisable to insert a glass rod or similar utensil (not metal) into the liquid whilst reheating.
4. Let liquid stand for at least 20 seconds in the oven at the end of cooking time to prevent delayed eruptive boiling.
3. Pierce the skin of such foods as potatoes, sausages and fruit before cooking, or they may explode.

To avoid the possibility of burns

1. Use pot holders or oven gloves when removing food from the oven to prevent burns.
2. Always open containers, popcorn makers, oven cooking bags, etc., away from the face and hands to avoid steam burns and eruption of boiling.
3. **To avoid burns, always test food temperature and stir before serving and pay special attention to the temperature of food and drink given to babies, children or the elderly.**

Temperature of the container is not a true indication of the temperature of the food or drink; always check the food temperature.

4. Always stand back from the oven door when opening it to avoid burns from escaping steam and heat.
5. Slice stuffed baked foods after heating to release steam and avoid burns.

To avoid misuse by children

1. Do not lean or swing on the oven door.
2. Children should be taught all important safety instructions: use of pot holders, careful removal of food coverings; paying special attention to packaging (e.g. self-heating materials) designed to make food crisp, as they may be extra hot.

Other warnings

1. Never modify the oven in any way.
2. Do not move the oven while it is in operation.
3. This oven is for home food preparation only and may only be used for cooking food. It is not suitable for commercial or laboratory use.

To promote trouble free use of your oven and avoid damage.

1. Never operate the oven when it is empty except where recommended in the operation manual. Doing so may damage the oven.
2. When using a browning dish or self-heating material, always place a heat-resistant insulator such as a porcelain plate under it to prevent damage to the turntable and turntable support due to heat stress. The preheating time specified in the dish's instructions must not be exceeded.
3. Do not use metal utensils, which reflect microwaves and may cause electrical arcing. Use only the turntable and the turntable support designed for this oven. Do not operate the oven without the turntable.
4. Do not place anything on the outer cabinet during operation.



NOTE:

If you are unsure how to connect your oven, please consult an authorised, qualified electrician. Neither the manufacturer nor the dealer can accept any liability for damage to the oven or personal injury resulting from failure to observe the correct electrical connection procedure. Water vapour or drops may occasionally form on the oven walls or around the door seals and sealing surfaces. This is a normal occurrence and is not an indication of microwave leakage or a malfunction.

BUILT-IN KIT

No built-in kit is available for this oven.
This oven is designed to be used on a countertop only.

INSTALLATION



1. Remove all packing materials from the inside of the oven cavity and remove any protective film found on the microwave oven cabinet surface. Check the oven carefully for any signs of damage.
2. Place the oven on a secure, level surface, strong enough to take the oven weight, plus the heaviest item likely to be cooked in the oven. Do not place the oven in a cabinet.
3. Select a level surface that provides enough open space for the intake and/or outlet vents. The rear surface of appliance shall be placed against a wall.
 - A minimum space of 20cm is required between the oven and any adjacent walls.
 - Leave a minimum space of 30cm above the oven.
 - Do not remove the feet from the bottom of the oven.
 - Blocking the intake and/or outlet openings can damage the oven.
 - Place the oven as far away from radios and TV as possible. Operation of the microwave oven may cause interference to your radio or TV reception.

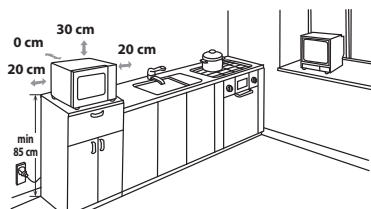

4. The oven door may become hot during cooking. Place or mount the oven so that the bottom of the oven is 85cm or more above the floor. Keep children away from the door to prevent them burning themselves.

5. Securely connect the plug of the oven to a standard earthed (grounded) household electrical outlet.

WARNING: Do not place the oven where heat, moisture or high humidity are generated, (for example, near or above a conventional oven) or near combustible materials (for example, curtains). Do not block or obstruct air vent openings. Do not place objects on top of the oven.

ELECTRICAL CONNECTION

- Do not allow water to come into contact with the power supply cord or plug.
- Insert the plug properly into the socket.
- Do not connect other appliances to the same socket using an adaptor plug.
- If the power supply cord is damaged, it must be replaced by a Sharp approved service facility or a similarly qualified person to avoid a hazard.
- When removing the plug from the socket always grip the plug, never the cord as this may damage the power supply cord and the connections inside the plug.



BEFORE OPERATION

Plug in the oven. The oven display will display: "0:00", an audible signal will sound once.

This model has a clock function and the oven uses less than 1.0 W in stand by mode. To set the clock, see below.



SETTING THE CLOCK

Your oven has a 24 hour clock feature.

1. Press the **LOCK/KITCHEN TIMER** button once. The hour figure will flash and the clock indicator will illuminate.
2. Rotate the **ENTRY** dial until the correct hour is displayed, the input time should be within 0-23.
3. Press the **LOCK/KITCHEN TIMER** button, the minute figure will flash.
4. Set the minutes. Rotate the **ENTRY** dial until the correct minutes are displayed, the input time should be within 0-59.
5. Press the **LOCK/KITCHEN TIMER** button to start the clock. The icon ":" of the digital time will be flashing on the display and the clock indicator will disappear.

NOTES:

- If the clock is set, when cooking is complete, the display will show the correct time of day. If the clock has not been set, the display will show "0:00".
- To check the time of day during a cooking process, press **LOCK/KITCHEN TIMER** button and the LED will display the time of day for 2-3 seconds. This does not affect the cooking process.
- If in the process of setting the clock, the **STOP/CLEAR** button is pressed, the oven will revert back to the former setting.
- If the electrical power supply to your microwave oven is interrupted, the display will intermittently show "0:00" after the power is reinstated. If this occurs during cooking, the programme will be erased. As will the time of day.



KITCHEN TIMER FUNCTION

You can use the kitchen timer function, for timing in instances where microwave cooking is not involved for example to time boiled eggs cooked on conventional hob or to monitor the standing time for cooked/defrosted food.

Example:

To set the timer for 5 minutes.

1. Press **LOCK/KITCHEN TIMER** button twice.
2. Rotate **ENTRY** dial to select time .
3. Press the **START/+30sec/ENTER** key to start the timer.
4. Check the display. (The display will count down through the programmed time.)

When the timer arrives at 0:00, an audible signal will sound 5 times and the LED will then display the time of day.

You can enter any time up to 95 minutes. To cancel the **KITCHEN TIMER** whilst counting down, simply press the **STOP/CLEAR** button.

NOTE: The **KITCHEN TIMER** function cannot be used whilst cooking.



MICROWAVE POWER LEVELS

Power Level	Press the MICRO.POWER button	Display (Percentage)
HIGH	x1	P100 (100%)
MEDIUM HIGH	x2	P80 (80%)
MEDIUM	x3	P50 (50%)
MEDIUM LOW (DEFROST)	x4	P30 (30%)
LOW	x5	P10 (10%)

- Your oven has 5 power levels, as shown.
- To change the power level for cooking, press the **MICRO.POWER** button or rotate the **ENTRY** dial key until the display indicates the desired level. Press the **START/+30sec./ENTER** button to confirm, enter the cooking time and then press the **START/+30sec./ENTER** button to start the oven.
- To check the power level during cooking, press the **MICRO.POWER** button, the current power level will be displayed for 2-3 seconds. The oven continues to count down although the display will show the power level.

Generally the following recommendations apply:

P100 - (HIGH output = 1000W) used for fast cooking or reheating e.g. for casseroles, hot beverages, vegetables etc.

P80 - (MEDIUM HIGH output = 800W) used for longer cooking of dense foods such as roast joints, meat loaf and plated meals, also for sensitive dishes such as sponge cakes. At this reduced setting, the food will cook evenly without over cooking at the sides.

P50 - (MEDIUM output = 500W) for dense foods which require a long cooking time when cooked conventionally, e.g. beef casserole, it is advisable to use this power setting to ensure the meat will be tender.

P30 - (MEDIUM LOW output = 300W) Defrost setting to defrost, select this power setting, to ensure that the dish defrosts evenly. This setting is also ideal for simmering rice, pasta, dumplings and cooking egg custard.

P10 - (LOW output = 100W) for gentle defrosting, e.g. cream gateaux or pastry.



Opening the door:

To open the oven door, pull the door opening handle.

Starting the oven:

Depending on the food type and the required end results, either place food into a suitable container, then place the container onto the turntable, alternatively place foods directly onto the turntable. Close the door and press the **START/+30sec./ENTER** button after selecting the desired cooking mode.

Once the cooking programme has been set and the **START/+30sec./ENTER** button is not pressed in 5 minutes, the setting will be cancelled. The **START/+30sec./ENTER** button must be pressed to continue cooking if the door is opened during cooking. An audible signal will once when pressing the button, if the button is inefficiently pressed there will be no sound detected.

Use the **STOP/CLEAR** key to:

1. Erase a mistake during programming.
2. Stop the oven temporarily during cooking.
3. Cancel a programme during cooking, press the **STOP/CLEAR** key twice.
4. To set and to cancel the child lock (refer to page GB-11).

MICROWAVE COOKING



Your oven can be programmed for up to 95 minutes (95:00).

The input unit of cooking (defrosting) time varies from 5 seconds to 95 minutes. It depends on the total length of the cooking (defrosting) time as shown on the table.

Cooking Time	Increasing Unit
0-1 minute	5 seconds
1-5 minutes	10 seconds
5-10 minutes	30 seconds
10-30 minutes	1 minute
30-95 minutes	5 minutes

MANUAL COOKING/MANUAL DEFROSTING

- Enter the cooking time and use the microwave power levels P100 to P10 to cook or defrost (see example below).
- Stir or turn the food, where possible, 2 - 3 times during cooking.
- After cooking, cover the food and leave to stand, where recommended.
- After defrosting, cover the food in foil and leave to stand until thoroughly defrosted.

Example:

To cook for 2 minutes and 30 seconds on 80% microwave power.

1. Input the power level by pressing the **MICRO.POWER** button twice for P80 or turn the **ENTRY** dial to select the microwave power to P80.

MICRO.POWER x2 or 

2. Press the **START/+30sec./ENTER** button to confirm the selected power level.



At the same time the microwave indicator will illuminate on the display.

3. Enter desired cooking time by rotating the **ENTRY** dial.



4. Press the **START/+30sec./ENTER** button to start the timer. (The display will count down through the programmed cooking time.)



NOTE:

- When the oven starts, the oven lamp will light and the turntable will rotate clockwise or anticlockwise. If the door is opened during cooking/defrosting to stir or turn over food, the cooking time on the display stops automatically. The cooking/defrosting time starts to count down again when the door is closed and the **START/+30sec./ENTER** button is pressed.
- When cooking/defrosting is complete, the time of day will reappear on the display, if the clock has been set.
- If you wish to know the power level during cooking, press the **MICRO.POWER** button. The current power level will be displayed for 2-3 seconds.

IMPORTANT:

- Close the door after cooking/defrosting. Please note that the light will remain on for 10 minutes when the door is open, this is for safety reason to remind you to close the door.

GRILL COOKING/COMBI COOKING



1. GRILL ONLY COOKING

The grill at the top of the oven cavity has one power setting only. The grill is assisted by the turntable which rotates simultaneously to ensure even browning. Use the rack for grilling small items of food such as bacon, gammon and teacakes. Food can be placed either directly onto the rack, or into a flan dish/heat-resistant plate on the rack.

Example:

To grill for 20 minutes, using **GRILL/COMBI** button.

1. Press **GRILL/COMBI** button once. G-1 and the grill indicator will illuminate on the display.

GRILL/COMBI. x1



2. Press the **START/+30sec./ENTER** button to confirm the cooking mode.



3. Use the **ENTRY** dial to input the grilling time (20 minutes).



4. Press the **START/+30sec./ENTER** button once more to start the grilling. (The display will count down through the programmed grilling time.)





GRILL COOKING/COMBI COOKING

Note:

Halfway through the grilling time an audible signal will sound twice this will remind you to turn the food over to ensure even browning. Please be aware that the oven will not stop automatically during grilling. Turnover the food halfway through, close the door and then press the **START/+30sec./ENTER** button to continue grilling.

2. GRILL/COMBI. COOKING

The **GRILL/COMBI. COOKING** feature enables a combination microwave power with grill or/and convection as well as the combination of grill and convection. **GRILL/COMBI.** means to cook by microwave power, grill power and/ or convection power alternately. The combination cooking reduces cooking time and provides a crisp, brown finish giving you the convenience of fast cooking with a traditional appetising appearance.

There are 4 choices for the combination as shown in the chart below:

Press GRILL/COMBI. button	Display	Microwave	Grill	Convection
twice	C-1	•		•
3 times	C-2	•	•	
4 times	C-3		•	•
5 times	C-4	•	•	•

• = available

Example for Microwave and Convection:

To cook for 30 minutes using the combination of microwave and convection (C-1).

1. Press **GRILL/COMBI.** button once. G-1 will illuminate on the display.
2. Select C-1 by pressing the **GRILL/COMBI** button once more or turn the **ENTRY** dial until the display shows C-1. At the same time microwave and convection indicator will illuminate.
3. Press the **START/+30sec./ENTER** button to confirm the cooking mode.
4. Use the **ENTRY** dial to input the cooking time (30 minutes).
5. Press the **START/+30sec./ENTER** button to start the cooking. (The display will count down through the programmed cooking time.)

GRILL/COMBI. x1



NOTES for GRILL and COMBI COOKING:

- It is not necessary to preheat the grill.
- When browning food place it either on the low or high rack or in a deep container on the truntable.
- You may detect smoke or a burning smell when using the grill for the first time. This is normal and not a sign that the oven has malfunctioned. To avoid this problem, when first using the oven, heat the oven without food for 20 minutes on grill and then on convection at 240°C.

IMPORTANT: During operation, to allow smoke or smells to disperse open a window.



WARNING:

The door, outer cabinet, oven cavity and accessories will become very hot during operation. To prevent burns, always use thick oven gloves.



CONVECTION COOKING

Your oven can be used as a conventional oven using the convection facility, there are 10 pre-set oven temperatures. Preheating is recommended for better results. The temperature can be chosen from 150°C to 240°C in 10°C increments.

Press CONVECTION button	1	2	3	4	5	6	7	8	9	10
Oven Temp (°C)	150	160	170	180	190	200	210	220	230	240

Example 1: To cook with preheating

To preheat to 200°C and cook for 25 minutes at 200°C.

1. Press the **CONVECTION** button once and the temperature indicator will flash on the display and the convection indicator will illuminate.
2. Enter the desired preheat temperature by pressing the **CONVECTION** button (5 more times) or turn the **ENTRY** dial until the display shows 200.
3. Press the **START/+30sec./ENTER** button to confirm the temperature.

CONVECTION x1

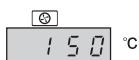

4. Press the **START/+30sec./ENTER** button once more to start preheating. When the preheated temperature has been reached an audible signal will sound twice to remind you to put the food into the oven. The current temperature will flash in the display.
5. Open the door, place the food inside the oven and close the door. Use the **ENTRY** dial to input the cooking time (25 minutes).
6. Press the **START/+30sec./ENTER** button to start cooking. The display will count down through the programmed cooking time. The convection indicator will flash.

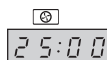
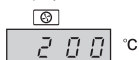



Example 2: To cook without preheating

To cook at 230°C for 20 minutes.

1. Open the door, place the food inside the oven and close the door. Press the **CONVECTION** button once and the temperature indicator will flash on the display and the convection indicator will illuminate.
2. Enter the desired temperature by pressing the **CONVECTION** button (8 more times) or turn the **ENTRY** dial until the display shows 230.
3. Press the **START/+30sec./ENTER** button to confirm the temperature.
4. Use the **ENTRY** dial to input the cooking time (20 minutes).
5. Press the **START/+30sec./ENTER** button to start cooking.

CONVECTION x1

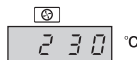
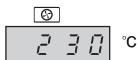

Notes :

1. The cooking time cannot be input until the preheating temperature arrives. When the oven arrives at desired temperature, the door must be opened to input the cooking time.
2. The convection heater will stop automatically; if there is no input of the cooking time within 5 minutes. An audible signal will sound five times to remind you and the LED will display the time of day, if the clock has been set. If the clock has not been set, the display will only show "0:00".
3. When the oven is preheating, the turntable should remain in the oven. During preheating and convection cooking, you will hear the cooling fan cycling on and off. This is completely normal and does not affect the cooking.
4. Food manufacturers instructions are only a guideline, so cooking times may need to be adjusted
5. After cooking is complete the cooling fan will continue working for a short time to lower the temperature of the electrical and mechanical parts.
6. You may detect smoke or a burning smell when using convection for the first time. This is normal and is not a sign that the oven has malfunctioned. To avoid this problem, when first using the oven, heat the oven without food for 20 minutes on grill and then convection at 240°C.

IMPORTANT: During operation, to allow smoke or smells to disperse open a window.



WARNING:

The door, outer cabinet, oven cavity and accessories will become very hot during operation. To prevent burns, always use thick oven gloves.

OTHER CONVENIENT FUNCTIONS



1. SEQUENCE COOKING

This function quickly defrosts food while enabling you to choose a suitable defrost period, depending on the food type. Follow the example below for details on how to operate this function. The time range is 0:05 – 95:00. This function allows you to cook using up to 2 different stages which can include manual cooking time or time defrost as well as weight defrost function. Once programmed there is no need to interfere with the cooking operation as the oven will automatically move onto the next stage. An audible signal will sound once after the first stage. If one chosen stage is defrosting, this should be the first stage of sequence cooking.

Note: **AUTO MENU** cannot be set as one of the multiple sequences.

Example: If you want to defrost the food for 5 minutes, then to cook with P80 microwave power for 7 minutes. The steps are as follows:

- 1. Press the **WEIGHT/TIME DEFROST** button twice, in the LED display d-2 will appear.
- 2. Enter the defrosting time by rotating the **ENTRY** dial until the display shows "5:00" minutes.
- 3. Press the **MICRO.POWER** button once.
- 4. Input the power level by pressing the **MICRO.POWER** button once more for P80 or turn the **ENTRY** dial to select the microwave power to P80.
- 5. Press the **START/+30sec./ENTER** button to confirm the setting.
- 6. Enter the cooking time by rotating the **ENTRY** dial until the display shows "7:00" minutes.
- 7. Press the **START/+30sec./ENTER** button to start cooking.

2. +30sec FUNCTION (Direct start)

The **START/+30sec./ENTER** button allows you to operate the following function:

a. Direct start

You can directly start cooking on P100 microwave power level for 30 seconds by pressing the **START/+30sec./ENTER** button. The cooking process will start immediately and each time the button is pressed this will increase the cooking time by 30 seconds.

b. Extend the cooking time

You can extend the cooking time during manual, grill, convection, combi cooking and time defrost in multiples of 30 seconds if the **START/+30sec./ENTER** button is pressed while the oven is in operation. During weight defrost and auto menu function and sequence cooking, the cooking time cannot be increased by pressing **START/+30sec./ENTER** button.

NOTE: The cooking time may be extended to a maximum of 95 minutes.

3. CHILD LOCK:

Use to prevent unsupervised operation of the oven by children.

a. To set the CHILD LOCK:

Press and hold the **STOP/CLEAR** key for 3 seconds until a long beep sounds. The display will illuminate the lock indicator: 

b. To cancel the CHILD LOCK:

Press and hold the **STOP/CLEAR** key for 3 seconds until a long beep sound. The lock indicator will disappear.



WEIGHT DEFROST AND TIME DEFROST FUNCTION

1. WEIGHT DEFROST

The microwave oven is pre-programmed with a timer and power levels so that foods such as pork, beef and chicken can be easily defrosted. The weight range for this is from 100g – 2000g in 100g steps.

Follow the example below for guidance on how to operate these functions.

Example: To defrost a meat joint weighing 1.2kg using **WEIGHT DEFROST**.

Place the meat in a flan dish or alternatively on a microwave oven defrost rack on the turntable.

1. Select the menu required by pressing the **WEIGHT/TIME DEFROST** button once.
2. Enter the desired weight by rotating the **ENTRY** dial until the display shows:
3. Press the **START/+30sec./ENTER** button to start defrosting. The microwave and defrost indicators will illuminate and "g" indicator will disappear. (The display will count down through defrosting time).

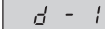
the display will show: 

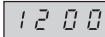

At the same time "g" indicator will illuminate on the display.

Frozen foods are defrosted from -18°C.

Notes for WEIGHT DEFROST:

- Before freezing foods, ensure food is fresh and of good quality.
- Place food with a weight less than 200g at the edge of the turntable try to avoid placing it in the centre of the turntable.
- Food weight should be rounded up to the nearest 100g, for example, 650g to 700g.
- If necessary, shield small areas of meat or poultry with flat pieces of aluminium foil. This will prevent the areas from becoming warm during defrosting. Ensure the foil does not touch the oven walls.

2. TIME DEFROST

This function quickly defrosts food while enabling you to choose a suitable defrost period, depending on the food type. Follow the example below for details on how to operate this function. The time range is 0:05 – 95:00.

Example: To defrost food for 10 minutes.

1. Select the menu required by pressing the **WEIGHT/TIME DEFROST** button twice.
2. Enter the desired cooking time by rotating the **ENTRY** dial until the display shows:
3. Press the **START/+30sec./ENTER** button to start defrosting. The microwave and defrost indicators will illuminate.

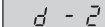
the display will show: 



Frozen foods are defrosted from -18°C.

Notes for TIME DEFROST:

- After cooking an audible signal will sound five times and the LED will then display the time of day, if the clock has been set. If the clock has not been set, the display will only show "0:00" when cooking is complete.
- The preset microwave power level is P30 and cannot be changed.



AUTO MENU FUNCTION

The **AUTO MENU** programmes automatically work out the correct cooking mode and cooking of the foods (details on page GB-13). Follow the example below for guidance on how to operate this function.

Example: To cook 350g carrots by using the **AUTO MENU** function for fresh vegetables (A5).

1. Rotate the **ENTRY** dial and select the desired auto menu.
2. Press the **START/+30sec./ENTER** button to confirm the setting.
3. Enter the desired weight by rotating the **ENTRY** dial until the display shows:
4. Press the **START/+30sec./ENTER** button to start cooking. (The display will count down through defrosting time)







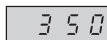

At the same time "g" indicator will illuminate on the display.

NOTES:

- The weight or quantity of the food can be input by rotating the **ENTRY** dial until the desired weight/quantity is displayed.
- Enter the weight of the food only. Do not include the weight of the container.
- For food weighing more or less than the weights/quantities given in the **AUTO MENU** chart on page GB-13 cook by manual operation.



Auto Menu	Display	Cooking method	WEIGHT/ PORTION / UTENSILS	Procedure
Frozen pizza (oven ready pizza → prebaked)	A1	C-4	200g, 300g, 400g (initial temp. -18°C) Low Rack	Remove packaging and place directly on the low rack. No standing time is required.
Jacket Potato	A2	100% Micro	1, 2, 3 potatoes (pieces) 1 potato = approx. 230g (initial temp. 20°C)	Please use potatoes with a similar size of approx. 230g. Pierce each potato in several places and place towards the edge of the turntable. Turn over and re-arrange halfway through cooking. Stand for 3 - 5 minutes before serving.
Meat (boneless meat e.g.)	A3	C-2	150g, 300g, 450g, 600g (initial temp 5°C)	Cut the meat into small strips and place it in a flan dish. Use vented microwave cling film or a suitable.
Fish (Only fish fillet is recommended for this programme)	A4	80% Micro	150g, 250g, 350g, 450g, 650g (initial temp. temp 20°C) Flan dish and vented microwave cling film or suitable lid	Place in a single layer in a flan dish. Use vented microwave cling film or a suitable lid to cover.
Fresh vegetables e.g. cauliflower, carrots, broccoli, fennel, leek, pepper, courgettes etc.	A5	100% Micro	150g, 350g, 500g (initial temp 20°C) Bowl and lid	Cut, chop or slice fresh vegetables into evenly sized pieces. Place the fresh vegetables in a suitable container. Place on the turntable. Add the required amount of water (1 tbsp per 100 g). Cover with a lid. Stir after cooking and let the food stand for approx. 2 minutes.
Beverage	A6	100% Micro	1 (cup) 240ml 2 (cups) 480ml 3 (cups) 720ml (initial temp. 5°C)	Place the cup(s) on the turntable and stir after heating.
Pasta (dried pasta e.g. Fusilli, Farfalle, Rigatoni)	A7	80% Micro	Pasta Water 50g 450 ml 100g 800 ml 150g 1200 ml (initial temp. for the water: 20°C) large, wide bowl	Place pasta in an appropriate sized bowl and add the water. Do not cover. Place the bowl in the centre of the turntable. After cooking, stir well and stand for 2 minutes before draining.
Popcorn	A8	100% Micro	0.05kg, 0.1kg	Place the popcorn bag directly on the turntable (Please see the note below: 'Important Information About Microwave Popcorn Feature')
Sponge cake* Ingredients: 4 eggs 100g flour 110g sugar, 10g corn starch 60g milk 60g vegetable oil	A9	Preheat at 180°C	475g (initial temp. 20°C) Spring form tin (about 26 cm diameter) Low rack	The oven will preheat to 180°C. When the temperature is reached, open the door and place the cake on the low rack inside. Press the START/+30sec./ENTER button to start the baking.
Roast chicken	A10	C-4	500g, 750g, 1000g, 1200g (initial temp. 20°C) Low Rack	If desired, season with salt, pepper and paprika. Pierce the skin of the chicken a few times. Place the chicken, breast side up, onto the low rack.

*** Preparation of the sponge cake (A9):**

1. Separate the eggs.
2. Cream the egg yolks, milk and vegetable oil with a hand blender (low speed) until light and fluffy.
3. Add the flour and mix well.
4. In a separate dish, beat the egg whites, sugar and corn starch with a hand blender (high speed) until stiff. Carefully fold into the cake mixture.
5. Spoon the mixture into a greased spring form tin and smooth the surface.
6. After preheating place the spring form tin on the rack.

Notes:

- The final temperature will vary according to the initial food temperature. Check food is piping hot after cooking. If necessary, you can extend the cooking manually.
- The results when using auto cook depend on variances such as the shape and size of the food and your personal preference as regards cooking results. If you are not satisfied with the programmed result, please adjust the cooking time to match your requirement.

Important Information about Microwave Popcorn Feature:

1. When selecting 0.1 kg of popcorn, it is suggested that you fold down a triangle on each corner of the bag before cooking.
Refer to the picture at right.



2. If/When the popcorn bag expands and no longer rotates properly, please press **STOP/CLEAR** key once and open the oven door and adjust the bag position to ensure even cooking.

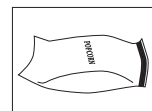



SUITABLE OVENWARE

To cook/thaw food in a microwave oven, the microwave energy must be able to pass through the container to penetrate the food. Therefore it is important to choose suitable cookware.

Round/oval dishes are preferable to square/oblong ones, as the food in the corners tends to overcook. A variety of cookware can be used as listed below.

Cookware	Microwave Safe	Grill	Convection	Mix Cook	Comments
Aluminium foil Foil containers	✓ / ✗	✓	✓	✓ / ✗	Small pieces of aluminium foil can be used to shield food from overheating. Keep foil at least 2cm from the oven walls, as arcing may occur. Foil containers are not recommended unless specified by the manufacturer, e.g. Microfoil [®] , follow instructions carefully.
Browning dishes	✓	✗	✗	✗	Always follow the manufacturer's instructions. Do not exceed heating times given. Be very careful as these dishes become very hot.
China and ceramics	✓ / ✗	✗	✓	✓ Mix Conv. only	Porcelain, pottery, glazed earthenware and bone china are usually suitable, except for those with metallic decoration.
Glassware e.g. Pyrex [®]	✓	✓	✓	✓	Care should be taken if using fine glassware as it can break or crack if heated suddenly.
Metal	✗	✓	✓	✗	It is not recommended to use metal cookware as it will arc, which can lead to fire.
Plastic/Polystyrene e.g. fast food containers	✓	✗	✓	✓ / ✗	Care must be taken as some containers warp, melt or discolour at high temperatures.
Cling film	✓	✗	✗	✗	It should not touch the food and must be pierced to let the steam escape.
Freezer/Roasting bags	✓	✗	✓ / ✗	✗	Must be pierced to let steam escape. Ensure bags are suitable for microwave use. Do not use plastic or metal ties, as they may melt or catch fire due to the metal 'arcing'.
Paper - plates, cups and kitchen paper	✓	✗	✗	✗	Only use for warming or to absorb moisture. Care must be taken as overheating may cause fire.
Straw and wooden containers	✓	✗	✗	✗	Always supervise the oven when using these materials as overheating may cause fire.
Recycled paper and newspaper	✗	✗	✗	✗	May contain extracts of metal which will cause 'arcing' and may lead to fire.
Rack	✓	✓	✓	✓	The metal racks supplied have been specially designed for all cooking modes and will not damage the oven.



WARNING:

When heating food in plastic or paper containers, monitor the oven due to the possibility of ignition.



CAUTION: DO NOT USE COMMERCIAL OVEN CLEANERS, STEAM CLEANERS, ABRASIVE, HARSH CLEANERS, ANY THAT CONTAIN SODIUM HYDROXIDE OR SCOURING PADS ON ANY PART OF YOUR MICROWAVE OVEN.

Before cleaning, make sure the oven cavity, door, oven cabinet and accessories are completely cool.

CLEAN THE OVEN AT REGULAR INTERVALS AND REMOVE ANY FOOD DEPOSITS – Keep the oven clean, or the oven could lead to a deterioration of the surface. This could adversely affect the life of the appliance and possibly result in a hazardous situation.

Oven exterior

The outside of your oven can be cleaned easily with mild soap and water. Make sure the soap is wiped off with a moist cloth, and dry the exterior with a soft towel.

Oven controls

Open the door before cleaning to de-activate the oven controls. Care should be taken when cleaning the oven control. Using a cloth dampened with water only, gently wipe the panel until it becomes clean. Avoid using excessive amounts of water. Do not use any sort of chemical or abrasive cleaner.

Oven Interior

1. For cleaning, wipe away any splatters or spills with a soft damp cloth or sponge after each use while the oven is still warm. For heavier spills, use a mild soap and wipe several times with a damp cloth until all residues are removed. Built-up splashes may overheat and begin to smoke or catch fire, and cause arcing. Do not remove the waveguide cover.
2. Make sure that the mild soap or water does not penetrate the small vents in the walls which may cause damage to the oven.
3. Do not use spray type cleaners on the oven interior.

4. Heat up your oven regularly by using the convection and grill. Remaining food or fat splashed can cause smoke or bad smell.
5. Food will release steam during cooking and cause condensation inside the oven and door. It is important to wipe the oven dry. A build up of condensation will eventually lead to rust forming on the oven interior.

SPECIAL NOTE for WAVEGUIDE COVER: Keep the waveguide cover clean at all times. The waveguide cover is constructed from a fragile material and should be cleaned with care (follow the cleaning instructions above).

Excessive soaking may cause disintegration of the waveguide cover. The waveguide cover is a consumable part and without regular cleaning, will need to be replaced.

Accessories

The accessories like turntable, turntable support, rack and crisp plate should be washed in a mild washing up liquid solution and dried. They are dishwasher safe.

SPECIAL NOTE for TURNABLE SUPPORT:

After cooking, always clean the turntable support, especially around the rollers. These must be free from food splashes and grease. Built-up splashes or grease may overheat and cause arcing, begin to smoke or catch fire.

Door

To remove all traces of dirt, regularly clean both sides of the door, the door seals and adjacent parts with a soft, damp cloth. Do not use harsh abrasive cleaners or sharp metal scrapers to clean the glass oven door since they can scratch the surface, which may result in shattering of the glass.

NOTE: A steam cleaner should not be used.

Cleaning tip - For easier cleaning of your oven:

Place half a lemon in a bowl, add 300ml (1/2 pint) water and heat on 100% for 10-12 minutes.

Wipe the oven clean using a soft, dry cloth.



If you think the oven is not working properly there are some simple checks you can carry out yourself before calling an engineer. This will help prevent unnecessary service calls if the fault is something simple.

Follow this simple check below:

Place half a cup of water on the turntable and close the door. Programme the oven to cook for 1 minute using 100% microwave power.

1. Does the oven lamp come on when it is cooking?
2. Does the turntable rotate?
3. Does the cooling fan work? (Check by placing your hand above the air vent openings.)
4. After 1 minute does the audible signal sound?
5. Is the water in the cup hot?
Take the cup of water out of the oven and close the door. Programme the oven to cook for 3 minutes using the top grill.
6. After 3 minutes, does the grill heating element become red?
Programme the oven to cook for 3 minutes using the convection on 240°C.
7. After 3 minutes, is the oven cavity hot?
If you answer "NO" to any question first check that the oven is plugged in properly and the fuse has not blown. If there is no fault with either, check against the troubleshooting chart on the following page.

NOTES:

• Safety powerdowns:

If you cook food for more than the standard time (see chart opposite) using the same cooking mode, the oven's safety mechanisms automatically activate. The microwave power level will be reduced or the grill heating elements will turn on and off.

• After manual or automatic cooking using the Grill, Combi or

Convection modes, the cooling fan will switch on to cool the oven cavity. When the cooling fan works, the display may show "NOW COOLING". To clear it, press the **STOP/CLEAR** key and the display will return to "0". During these modes, the cooling fan will carry on working after you have pressed the **STOP/CLEAR** key. You may feel hot air blowing out of the air-vent openings.

WARNING: Never adjust, repair or modify the oven yourself. It is hazardous for anyone other than a SHARP trained engineer to carry out servicing or repairs. This is important as it may involve the removal of covers that provide protection against microwave energy.

- The door seal stops microwave leakage during oven operation, but does not form an airtight seal. It is normal to see drops of water, light or feel warm air around the oven door. Food with a high moisture content will release steam and cause condensation inside the door which may drip from the oven.
- **Repairs and Modifications:** Do not attempt to operate the oven if it is not working properly.
- **Outer Cabinet & Lamp Access:** Never remove the outer cabinet. This is very dangerous due to high voltage parts inside which must never be touched, as this could be fatal. Your oven is not fitted with a lamp access cover. If the lamp fails, do not attempt to replace the lamp yourself, call a SHARP approved service facility.

IMPORTANT:

If you cook food for more than the standard time (see chart below) using the same cooking mode, the oven's safety mechanisms automatically activate. The microwave power level will be reduced or the grill heating element will turn on and off.



TROUBLESHOOTING

Cooking Mode	Standard time
Microwave P100	30 minutes
Grill/ Convection/ Combi cooking mode	Intermittent operation, temperature and time controlled

TROUBLESHOOTING CHART

QUERY	ANSWER
Draught circulates around the door.	When the oven is working, air circulates within the cavity. The door does not form an airtight seal so air may escape from the door.
Condensation forms in the oven, and may drip from the door.	The oven cavity will normally be colder than the food being cooked, and so steam produced when cooking will condense on the colder surface. The amount of steam produced depends on the water content of the food being cooked. Some foods, such as potatoes have a high moisture content. Condensation trapped in the door glass should clear after a few hours.
Flashing or arcing from within the cavity when cooking.	Arcing will occur when a metallic object comes into close proximity to the oven cavity during cooking. This may possibly roughen the surface of the cavity, but would not otherwise damage the oven.
Arcing potatoes.	Ensure all "eyes" are removed from the potatoes and that they have been pierced, place directly onto the turntable or in a heat resistant flan dish or similar.
The display is lit but the control panel will not work when pressed.	Check the door is closed properly.
Oven cooks too slowly.	Ensure correct power level has been selected.
Oven makes a noise.	The microwave energy pulses ON and OFF during cooking/defrosting.
Outer cabinet is hot.	The cabinet may become warm to the touch - keep children away.

SHARP