

SHARP®

DOUBLE GRILL CONVECTION MICROWAVE OVEN

雙重燒烤及熱風對流微波爐

KETUHAR PANGGANG DAN PEROLAKAN

GELOMBANG MIKRO DUA BELAH



R-898C(S)

R-890C(S)

OPERATION MANUAL AND RECIPES

使用說明書及食譜

BUKU PANDUAN OPERASI DAN RESIPI



CONTENTS

	Page
Warning	E-1
Special Notes and Warning.....	E-2
Installation Instructions.....	E-3
Oven Diagram	E-4
Operation of Control Panel	
Control Panel Display	E-4
Touch Control Panel Layout.....	E-5
Before Operating	
Getting Started.....	E-6
Stop/Clear.....	E-6
To Cancel Programme During Cooking.....	E-6
Power Interruption	E-6
Heating without Food.....	E-6
Clock Set Mode (Clock Setting).....	E-7
Energy Save Mode	E-7
Manual Operations	
Microwave Time Cooking.....	E-8
Sequence Cooking.....	E-9
Instant Cook	E-9
Slow Cook	E-10
Grill Cooking	E-11
Preheating	E-11
Convection Cooking.....	E-12
(1) To Cook without Preheating	E-12
(2) To Cook with Preheating.....	E-12
Mix Cooking.....	E-13
(1) To Cook by Mix Cooking.....	E-13
(2) To Cook by Convec Mix with Preheating.....	E-14
Automatic Operations	
Notes for Automatic Operations.....	E-15
How to Use Automatic Operations.....	E-15
Other Convenient Features	
Less/More Setting	E-16
Adjust Time During Cooking	E-16
Help Feature (INFO).....	E-17
(1) Auto Start.....	E-17
(2) Child Lock.....	E-17
(3) Demonstration Mode	E-17
(4) Language	E-17
(5) Help	E-17
Alarm	E-17
Care and Cleaning	E-18
Service Call Check.....	E-19
Specifications.....	E-19
Cooking Guides	
Microwave Cooking Techniques.....	E-20
Grill and Grill Mix Recipes	E-21
Auto Grill Menu Guide	E-25
Auto Rice Menu Guide	E-26
Auto Roast Menu Guide.....	E-27
Auto Reheat Menu Guide.....	E-28
Auto Bake Menu Guide	E-29
Auto Bake Recipe.....	E-30
Auto Steam Menu Guide	E-31
Crispy Reheat Menu Guide.....	E-32
Nonoil Fry Menu Guide	E-33
Easy Defrost Menu Guide	E-35

WARNING

IMPORTANT SAFETY INSTRUCTIONS: READ CAREFULLY AND KEEP FOR FUTURE REFERENCE.

1. To reduce the risk of fire in the oven cavity:
 - a. Do not overcook food.
 - b. Remove wire twist-ties from paper or plastic bags before placing bag in the oven.
 - c. Do not heat oil or fat for deep frying. The temperature of the oil cannot be controlled.
 - d. Look at the oven from time to time when food is heated in disposable containers made of plastic, paper or other combustible materials for signs of smoke or burning.
 - e. If materials inside the oven should ignite, or smoke is observed, keep oven door closed, turn oven off, and disconnect the power plug, or shut off power at the fuse or circuit breaker panel.
 - f. After use wipe the waveguide cover with a damp cloth, followed by a dry cloth to remove any food splashes and grease. Built-up grease may overheat and begin to cause smoke or catch fire.
2. To reduce the risk of an explosion or delayed eruptive boiling when handling the container. Your microwave oven is capable of heating food and beverages very quickly therefore, it is very important that you select the appropriate cooking time and power level for the type and quantity of food to be heated. If you are unsure of the cooking time and power level required, begin with low cooking times and power levels until the food is sufficiently heated evenly throughout.

Additionally:

 - a. Do not place sealed containers in the oven. Babies bottles fitted with a screw cap or teat are considered to be sealed containers.
 - b. Do not use excessive amount of time.
 - c. When boiling liquids in the oven, use a wide-mouthed container.
 - d. Stand at least for 20 seconds at the end of cooking to avoid delayed eruptive boiling of liquids.
 - e. Stir the liquid before and during cooking. Use extreme care when handling the container or inserting a spoon or other utensil into the container.
3. This oven is for home food preparation only and should only be used for heating, cooking and defrosting food and beverage.

It is not suitable for commercial, laboratory use, or heating therapeutic devices eg. Wheat bags.
4. Never operate the oven whilst any object is caught or jammed between the door and the oven.
5. Do not try to adjust or repair the oven yourself.

It is hazardous for anyone other than a qualified service technician trained by SHARP to carry out any service or repair operation. Especially those which involve the removal of a cover which gives protection against exposure to microwave energy are very hazardous.
6. Do not operate the oven if it is not working correctly or damaged until it has been repaired by a qualified service technician trained by SHARP. It is particularly important that the oven door closes properly and that there is no damage to:

(1) Door (warped), (2) Hinges and Latches (broken or loosened), (3) Door Seals, Sealing Surfaces and oven cavity (buckled or deformed), (4) Burn marks on the door seal faces.
7. Handle with care when removing items from the oven so that the utensil, your clothes or accessories do not touch the safety door latches.
8. Never poke an object, particularly a metal object, through a grille or between the door and the oven while the oven is operating.
9. Never tamper with or deactivate the door safety latches.
10. Always use oven gloves to prevent burns when handling utensils that are in contact with hot food. Enough heat from the food can transfer through utensils to cause skin burns.
11. Should the power supply cord become damaged, it must be replaced with a special cord supplied by a SERVICE CENTRE APPROVED BY SHARP. And it must be replaced by a qualified service technician trained by SHARP in order to avoid a hazard.
12. If the oven lamp fails please consult your dealer or a qualified service technician trained by SHARP.
13. Avoid steam burns by directing steam away from the face and hands.

Slowly lift the furthest edge of a dish's cover including microwave plastic wrap etc., and carefully open popcorn and oven cooking bags away from the face.
14. Make sure that the power supply cord is undamaged, and that it does not run under the oven or over any hot surfaces or sharp edges.
15. To prevent the turntable from breaking:
 - a. Before cleaning the turntable with water, leave the turntable to cool.
 - b. Do not place anything hot on a cold turntable.
 - c. Do not place anything cold on a hot turntable.
16. Do not place anything on the outer cabinet because the microwave oven will become very hot during the operation.
17. Do not store food or any other items inside the oven.
18. Make sure the utensil does not touch the interior walls during cooking.
19. This appliance is not intended for use by persons (including children) with reduced physical, sensory or mental capabilities, or lack of experience and knowledge, unless they have been given supervision or instruction concerning use of the appliance by a person responsible for their safety.
20. Children should be supervised to ensure that they do not play with the appliance.
21. Accessible parts (e.g. oven door, oven cavity, dishes and accessories) may become hot during use. To avoid burns young children should be kept away. Always use thick oven gloves to prevent yourself from getting burnt.
22. When the appliance is operated in the combination mode (Mix cooking), Grill or Automatic Operations, children should only use the oven under adult supervision due to the temperature generated.
23. During use the appliance becomes hot. Care should be taken to avoid touching heating elements inside the oven.

SPECIAL NOTES AND WARNING

	DO	DON'T
Eggs, fruits, nuts, seeds, vegetables, sausages and oysters	<ul style="list-style-type: none"> * Puncture egg yolks and whites and oysters before cooking to prevent "explosion". * Pierce skins of potatoes, apples, squash, hot dogs, sausages and oysters so that steam escapes. 	<ul style="list-style-type: none"> * Cook eggs in shells. This prevents "explosion", which may damage the oven or injure yourself. * Cook hard / soft boiled eggs. * Overcook oysters. * Dry nuts or seeds in shells.
Popcorn	<ul style="list-style-type: none"> * Use specially bagged popcorn for the microwave oven. * Listen while popping corn for the popping to slow to 1-2 seconds. 	<ul style="list-style-type: none"> * Pop popcorn in regular brown bags or glass bowls. * Exceed maximum time on popcorn package.
Baby food	<ul style="list-style-type: none"> * Transfer baby food to small dish and heat carefully, stirring often. Check for suitable temperature to prevent burns. * Remove the screw cap and teat before warming baby bottles. After warming shake thoroughly. Check for suitable temperature. 	<ul style="list-style-type: none"> * Heat disposable bottles. * Overheat baby bottles. Only heat until warm. * Heat bottles with nipples on. * Heat baby food in original jars.
General	<ul style="list-style-type: none"> * Food with filling should be cut after heating, to release steam and avoid burns. * Use a deep bowl when cooking liquids or cereals to prevent boiling over. 	<ul style="list-style-type: none"> * Heat or cook in closed glass jars or airtight containers. * Deep fat fry. * Heat or dry wood, herbs, wet papers, clothes or flowers. * Operate the oven empty except the directed case in the operation manual.
Liquids (Beverages)	<ul style="list-style-type: none"> * For boiling or cooking liquids see WARNING on page E-1 to prevent explosion and delayed eruptive boiling. 	<ul style="list-style-type: none"> * Heat for longer than recommended time.
Canned foods	<ul style="list-style-type: none"> * Remove food from can. 	<ul style="list-style-type: none"> * Heat or cook food while in cans.
Sausage rolls, Pies, Christmas pudding	<ul style="list-style-type: none"> * Cook for the recommended time. (These foods have high sugar and / or fat contents.) 	<ul style="list-style-type: none"> * Overcook as they may catch fire.
Meats	<ul style="list-style-type: none"> * Use a microwave proof rack or plate to collect drained juices. 	<ul style="list-style-type: none"> * Place meat directly on the turntable for cooking.
Utensils	<ul style="list-style-type: none"> * Check the utensils are suitable for MICROWAVE cooking before you use them. 	<ul style="list-style-type: none"> * Use metal utensils for MICROWAVE cooking. Metal reflects microwave energy and may cause an electrical discharge known as arcing.
Aluminium foil	<ul style="list-style-type: none"> * Use to shield food to prevent over cooking. * Watch for sparking. Reduce foil or keep clear of cavity walls. 	<ul style="list-style-type: none"> * Use too much. * Shield food close to cavity walls. Sparkling can damage the oven.
Browning dish	<ul style="list-style-type: none"> * Place a suitable insulator such as a microwave and heat proof dinner plate between the turntable and the browning dish. 	<ul style="list-style-type: none"> * Exceed the preheating time recommended by the manufacturer. Excessive preheating can cause the glass turntable to shatter and / or damage internal parts of the oven.

INSTALLATION INSTRUCTIONS

1. Remove all packing materials from the oven cavity , (do not remove the waveguide cover), and the feature sticker from the outside of the door, if there is one. Check the unit for any damage, such as a misaligned door, damaged door seals around the door or dents inside the oven cavity or on the door. If there is any damage, please do not operate the oven until it has been checked by a SERVICE CENTRE APPROVED BY SHARP and repaired, if necessary.
2. Accessories provided
1) Turntable 2) Low rack 3) High rack 4) Operation manual 5) 2 Cookbooks
6) Quick start guide
3. Since the door may become hot during cooking, and in order to avoid its accidental touch, the oven should be placed at least 80 cm or more above floor. You should also keep children away from the door to prevent them burning themselves.
4. Place the turntable over the turntable motor shaft on the oven floor. Refer to OVEN DIAGRAM on page E-4. NEVER operate the oven without the turntable.
5. This oven is designed to be used on a countertop only. It should not be installed in any area where excessive heat and steam are generated, for example, next to a conventional oven unit.
The oven should be installed so as not to block ventilation openings.
Allow space of at least 40cm from top of the oven for air ventilation.
This oven is not designed to be built-in to a wall or cabinet.
6. Neither the manufacturer nor the distributors can accept any liability for damage to the machine or personal injury for failure to observe the correct electrical connecting procedure.
The A.C. voltage and frequency must correspond to the one indicated on the rating label on the back of the oven.
7. This appliance must be earthed:

IMPORTANT

The wires in power supply cord are coloured in accordance with the following code:

Green-and-yellow	:	Earth
Blue	:	Neutral
Brown	:	Live

As the colours of the wires in the power supply cord of this appliance may not correspond with the coloured marking identifying the terminals in your plug, proceed as follows:

The wire which is coloured green-and-yellow must be connected to the terminal in the plug which is marked with the letter E or by the earth symbol \perp or coloured green or green-and-yellow.

The wire which is coloured blue must be connected to the terminal which is marked with the letter N or coloured blue.

The wire which is coloured brown must be connected to the terminal which is marked with the letter L or coloured brown.

OVEN DIAGRAM

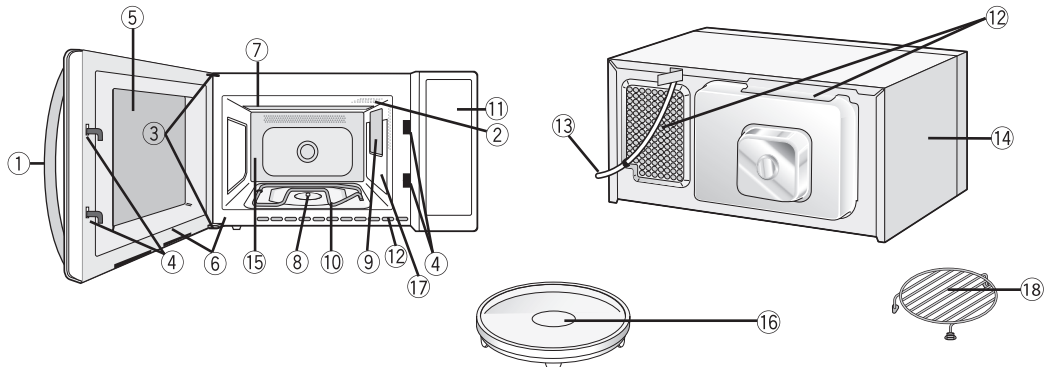

- | | |
|---|--|
| <ol style="list-style-type: none"> 1. Door open handle 2. Oven lamp 3. Door hinges 4. Door safety latches 5. See through door 6. Door seals and sealing surfaces 7. Top grill heater (top grill) 8. Turntable motor shaft 9. Waveguide cover (Do not remove) 10. Bottom grill heater (bottom grill) | <ol style="list-style-type: none"> 11. Control panel (See pages E-5) 12. Ventilation openings 13. Power supply cord 14. Outer cabinet 15. Oven cavity 16. Turntable 17. Rating label 18. Low rack 19. High rack |
|---|--|

Warning:

The accessories will become very hot whenever the top grill, bottom grill or convection symbols are lighted in the display, and use thick oven gloves when putting/removing the food or turntable from the oven to PREVENT BURNS.

OPERATION OF CONTROL PANEL

The operation of the oven is controlled by pressing the appropriate pads arranged on the surface of the control panel.

An entry signal tone should be heard each time you press the control panel to make a correct entry. In addition the oven will beep for approximately 2 seconds at the end of the cooking cycle, or 4 times when a cooking procedure is required.

Control Panel Display



1. TOP GRILL SYMBOL

It will appear when setting a programme using the top grill, or when the top grill is in use.

2. BOTTOM GRILL SYMBOL

It will appear when setting a programme using the bottom grill, or when the bottom grill is in use.

3. CONVECTION SYMBOL

It will appear when setting a programme using the convection mode, or when in a convection cooking.

4. MICROWAVE SYMBOL

It will appear when setting a programme using the microwave mode, or when in a microwave cooking.

5. MORE (▲)/LESS (▼) indicators

They will appear when setting the MORE or LESS function.

6. HELP indicator

It will appear when setting the HELP feature or an automatic operation.

7. COOK indicator

It will flash to inform you to press the START pad, or light when in the cooking.

Touch Control Panel Layout

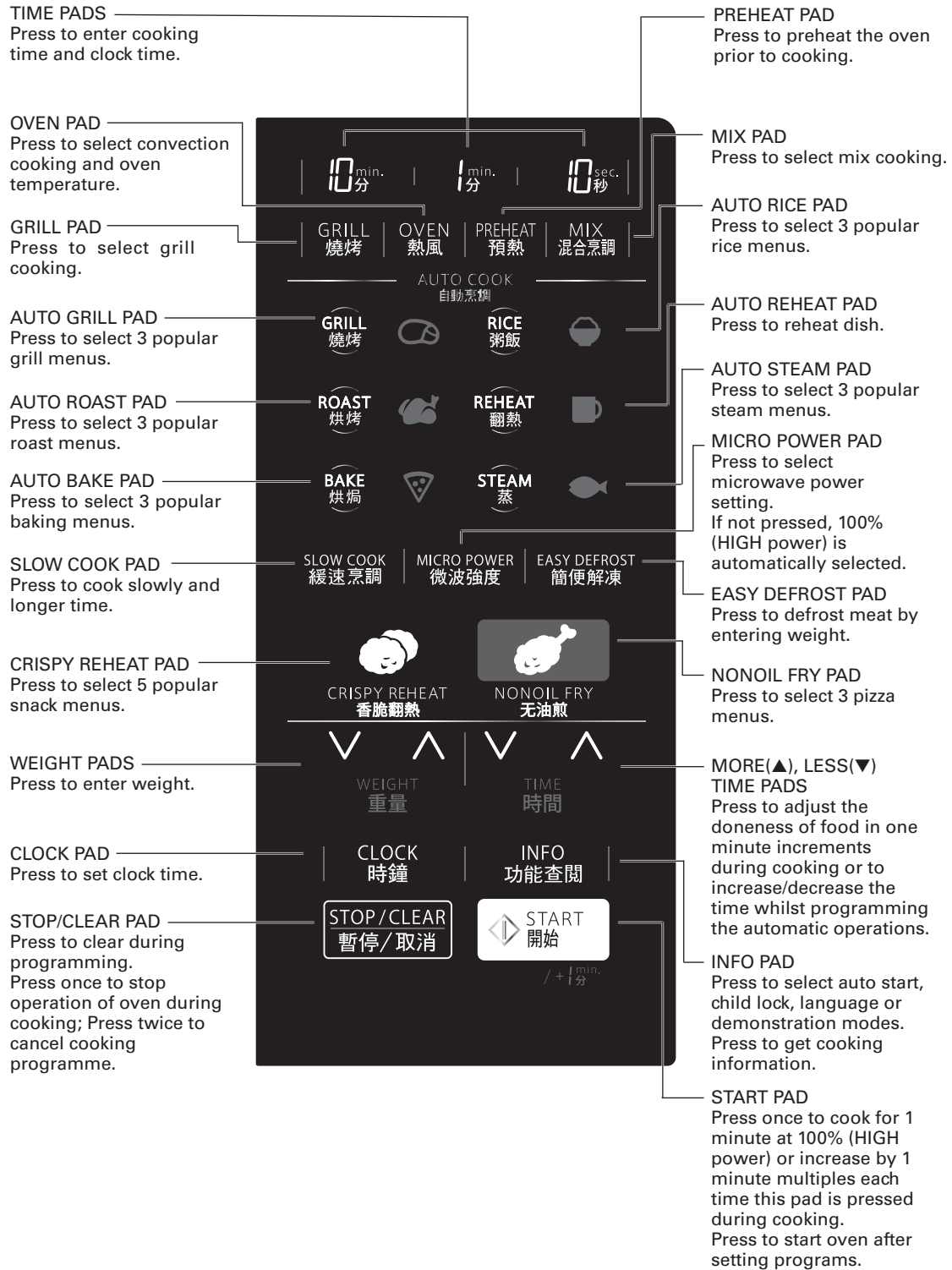

BEFORE OPERATING

* This oven is preset with the OPERATION GUIDE in English.

To assist you in programming your oven, the operation guide will appear in the display.

* You can get operation guide in English or Malay. To change the language, see page E-17.

Getting Started

Your oven has an Energy Save Mode. This facility saves electricity when the oven is not in use.

Step	Procedure
1	Plug the oven into a power point. Nothing will appear on the display at this time.
2	Open the door. The display will show ENERGY SAVE MODE TO CANCEL ENERGY SAVE MODE SET THE CLOCK.
3	Close the door. This display will show ". 0", and now you can ready to use the oven.

CAUTION:

In Energy Save Mode, if you do not operate the oven for 3 minutes or more (i.e. after closing the door, or pressing the **STOP/CLEAR** pad, or at the end of cooking), you will not be able to operate the oven until you open and close the oven door.

NOTE:

When you set Child Lock or Demonstration Mode, Energy Save Mode will be cancelled temporary.

Stop/Clear

Press the STOP/CLEAR pad once to:

1. Stop the oven temporarily during cooking.
2. Clear if you make a mistake during programming.

To Cancel a Programme During Cooking

Press the STOP/CLEAR pad twice.



Power Interruption

If the power goes off or the display is blank, refer to Step 2 and 3 in the above Getting Started to resume normal operation. Your oven works normally, however there is a case that previous setting such as Child Lock, Auto Start, and Demonstration Mode will be cancelled. The Display in Clock Set mode and Energy Save Mode under different conditions is listed on page E-7 for your reference.

Heating without Food

Some smoke and odor may occur for a while at the beginning of Grill, Preheat, Convection, Mix cooking or Automatic Operations (except Rice Menu, Reheat, Steam Menu and Easy Defrost), but the oven is not out of order.







To remove the cause of the smoke and odor, operate the oven without food for 20 min. on Grill using top and bottom grills before the first use and after cleaning.

Step	Procedure
1	Ensure that no food is in the oven. Press the GRILL pad 3 times. 
2	Enter the heating time (20 min.). 
3	Press the START pad.  The timer will begin to count down. When it reaches zero, all indicators will go out and audible signal will sound. NOW COOLING will appear on the display. The cooling fan will remain on until the oven cavity has been cooled. IMPORTANT: During this operation, some smoke and odor will occur. Therefore open the windows or run the ventilation fan in the room.
4	Open the door to cool the oven cavity. WARNING: The oven door, outer cabinet and oven cavity will become hot and pay attention to avoid burn when cooling the oven.

Clock Set Mode (Clock Setting)

If you set the clock (Clock Set Mode), Energy Save Mode does not work.

*To enter the present time of day 11:34 (AM or PM).

Step	Procedure
1	Press the CLOCK pad once. 
2	Enter the hours by pressing the TIME pads.  x 1  x 1
3	Press the CLOCK pad once to change from hours to minutes. 
4	Enter the minutes by pressing the TIME pads.  x 3  x 4
5	Press the CLOCK pad again. 

This is a 12-hour clock. If the clock is set, when cooking is complete, the display will show the correct time of day. If the clock has not been set, the display will only show ".0" when cooking is complete.

If the electrical power supply to your microwave oven is interrupted, plug in the oven again, then open the door. The display will show:
ENERGY SAVE MODE TO CANCEL ENERGY SAVE MODE SET THE CLOCK. If this occurs during cooking, the programme will be erased. The time of day will also be erased.

The clock of the oven works based on the frequency of power source. So it may gain or lose in some area where the frequency varies. It

is recommended that you should adjust the time occasionally.

If you wish to know the time of day during the cooking mode, press the CLOCK pad. As long as your finger is pressed the CLOCK pad, the time of day will be displayed.

Energy Save Mode



Your oven has an Energy Save Mode. In Energy Save Mode approximately 0.1 watt is used, when blank shows on the digital display. While in Clock Set Mode approximately 3 watt is used as the time will be shown. The Display in Clock Set Mode or Energy Save Mode under different conditions is listed below for your reference.

In Energy Save Mode, if you do not operate the oven for 3 minutes or more (i.e. closing the door, pressing the STOP/CLEAR pad, or at the end of cooking), the display will be blank and the oven cannot be used. To restore power on, open and then close the door, ".0" will be displayed and the oven is ready for use.

If you set the clock, Energy Save Mode will be cancelled.

To start Energy Save Mode manually, follow the instructions below.

* To start the Energy Save Mode (the display shows the time of day).

Step	Procedure
1	Press the CLOCK pad twice.  x 2
2	Press the START pad.  The power will be off and the display will show nothing.

The Display in Clock Set Mode or Energy Save Mode

Condition \ Mode	Clock Set Mode	Energy Save Mode
No cooking or no operating (Except Child Lock, Demo)	Current time	".0" or Blank (without operating over 3 minutes)
Child Lock Setting	Current time	".0" (Lock will be displayed by pressing a pad each time.)
Auto Start setting	Setting time	Auto Start can't be set in Energy Save Mode.
Demonstration Mode setting	DEMO MICROWAVE OVEN	
Power Interruption	Blank	

MANUAL OPERATIONS



Microwave Time Cooking

This is a manual cooking feature, first enter the cooking time then the power level. You can programme up to 99 minutes, 99 seconds. There are five different power levels.

Power level	Display	Examples
100% (HIGH)	100 P	Raw meat, Vegetables Rice or Pasta
70% (MEDIUM HIGH)	70 P	Delicate Foods such as Eggs or Seafood
50% (MEDIUM)	50 P	
30% (MEDIUM LOW)	30 P	Defrost, Softening butter
10% (LOW)	10 P	Keep food warm



This variable cooking control allows you to select the rate of microwave cooking. If a power level is not selected, then 100% (HIGH power) is automatically used.

* Suppose you want to cook for 10 minutes on 100% (HIGH power).

Step	Procedure
1	Enter desired cooking time. 
2	Press the START pad.  The timer begins to count down.

To lower the power, press the MICRO POWER pad once. Note the display will indicate 100P. To lower to "70P", press the MICRO POWER pad again. Repeat as necessary to select 50P, 30P or 10P power levels.

* Suppose you want to cook Fish Fillets for 10 minutes on 50% (MEDIUM power).

Step	Procedure
1	Select power level by pressing the MICRO POWER pad as required (for 50% press three times). 
2	Enter desired cooking time. 
3	Press the START pad.  The timer begins to count down.

If the door is opened during cooking process, the cooking time in the readout automatically stops. The cooking time starts to count down again when the door is closed and the START pad is pressed.

If you want to check the power level during the cooking, press MICRO POWER pad. As long as you press the MICRO POWER pad, the power level will be displayed.





If more than 20 minutes on 100% power is entered, the microwave power will be reduced after 20 minutes to avoid overheating.

MANUAL OPERATIONS

Sequence Cooking

Your oven can be programmed for up to 4 automatic cooking sequences, switching from one variable power setting to another automatically. Note that MICRO POWER must be entered first when programming sequence cooking.

* Suppose you want to cook for 10 minutes on 50% (MEDIUM power) followed by 5 minutes on 100% (HIGH power).

Step	Procedure
1	Select desired power level by pressing the MICRO POWER pad (for 50% press three times). 
2	Enter desired cooking time. 
3	For second sequence, select microwave cooking and power level (for 100% press the MICRO POWER pad once). 
4	Enter desired cooking time. 
5	Press the START pad.  The timer begins to count down to zero. When it reaches zero, the second sequence will appear and the timer will begin counting down to zero again.

Instant Cook™

For your convenience, Sharp's Instant Cook allows you to easily cook for one minute on 100% (HIGH power).

Step	Procedure
1	Press the START pad. (Within 3 minutes of closing the door.)  The timer begins to count down.

Press the START pad until desired time is displayed. Each time the pad is pressed, the cooking time is increased by 1 minute.



MANUAL OPERATIONS

Slow Cook

The SLOW COOK setting is designed for foods which cook longer time. For example, stewing, braising, boiling soup or Chinese desserts of liquid type. The SLOW COOK setting provides two choices: SLOW COOK HIGH or SLOW COOK LOW. The maximum cooking time is 2 hours for each choice when cook manually.

To select SLOW COOK HIGH, press the SLOW COOK pad once. SLOW COOK HIGH will be displayed. To select SLOW COOK LOW, press the SLOW COOK pad twice. SLOW COOK LOW will be displayed.

* Suppose you want to cook stew chicken on SLOW COOK HIGH for 1 hour 30 min.

Step	Procedure
1	Press the SLOW COOK pad once. 
2	Enter desired cooking time. 
3	Press the START pad.  The cooking time will count down to zero. After cooking an audible signal will sound.

NOTE:

1. If you need to check the food doneness during cooking, you can open the oven door or pressing the STOP/CLEAR pad once, then check and stir. After that close the door and press START pad to resume cooking.
2. You can **only** set any SLOW COOK programmes up to 2 stages as a sequence cooking (see page E-9).
3. If you wish to know the level of slow cook during cooking, press the MICRO POWER pad. As long as your finger is pressing the MICRO POWER pad, selected slow cook setting will be displayed.

4. Maximum time of Slow Cook is 2 hours.
5. This function can be used with AUTO START. See page E-17

SPECIAL NOTES ON SLOW COOKING

For better cooking result, always try to:

1. Cut the ingredients into smaller pieces.
2. Add in adequate liquid medium (e.g. : water, sauce) and try to submerge the ingredients into the liquid medium in order to avoid scorching. This is especially important when stew or chicken soup is prepared.
3. When soup or large quantity is prepared, make sure that the water level is at least 1 1/2 inches (3.8cm) from the rim of casserole, otherwise spill over may result.
4. Do not add too much seasonings or salt at the initial stage of cooking. Try to add (especially salt) soon after or just after finish.
5. Cook with the casserole lid on. Also please do not open the lid during cooking as this may disturb the cooking sequence.
6. Stir and stand for 10 minutes after cooking.

MANUAL OPERATIONS

Grill Cooking

The top and bottom grills have one power setting only. Use appropriate time for steaks, chops, chicken pieces or other grilled food to achieve optimum results of cooking.

Your oven has 3 grill cooking modes. Select the desired grill mode by pressing the GRILL pad.



Grill cooking Mode	Press the GRILL pad
Top Grill mode	Once
Bottom Grill mode	Twice
Double Grill mode (top and bottom)	3 times

It is not necessary to preheat for grill cooking.

Recommended Utensils:

- High rack
- Low rack
- Aluminium foil container
- Heat resistant cookware

* Suppose you want to cook for 20 minutes using the double grill mode.

Step	Procedure
1	Press the GRILL pad 3 times.  x 3
2	Enter desired cooking time.  x 2
3	Press the START pad.  The timer begins to count down.

NOTE:

After cooking the oven will automatically cool and the display will show NOW COOLING.



WARNING:

The door, outer cabinet, oven cavity, accessories, dishes and especially the grills will become very hot during operation. To prevent burns, always use thick oven gloves.

Preheating

For best results of Convection and Convection Mix cooking, preheat to the required temperature (250, 230, 220, 200, 180, 160, 130, 100, 70, 40°C). Add food after preheating.

* To preheat the oven to 200°C

Step	Procedure
1	Select preheating temperature by pressing the PREHEAT pad as required (for 200°C press four times).  x 4
2	Press the START pad.  PREHEAT will be displayed. When preheat is over, the oven will "beep" 4 times and ADD FOOD will be displayed.
3	Open the door and place food. Close the door. PRESS CONVEC OR MIX will be displayed repeatedly.
4	Enter the desired setting.

NOTES:

1. The preheated temperature will be maintained for 30 minutes. Once the oven door is opened, this function will be cancelled. After 30 minutes, preheat will be cancelled.
2. When you set the preheat, the preset convection temperature will be automatically changed to the preheated temperature. After preheating, if you want to cook at a different temperature press the OVEN pad and you want to change Mix cooking mode (see Page E-13), press the MIX pad at step 4 until the desired setting appears on the display.
3. You can check the actual temperature during preheating by pressing the OVEN pad. The temperature will appear on the display. This will not affect the oven operation. If the oven temperature is below 40°C, LO C will be displayed.

WARNING:

The door, outer cabinet, oven cavity, accessories, dishes and especially the grills will become very hot during operation. To prevent burns, always use thick oven gloves.

MANUAL OPERATIONS

Convection Cooking

Your oven has 10 preset convection temperatures (250, 230, 220, 200, 180, 160, 130, 100, 70, 40°C). When you press the OVEN pad once, 250°C will be selected. To lower the temperature, press the OVEN pad until the desired temperature appears in the display.

Please consult your Convection Microwave Cookbook for more specific cooking instructions and procedures.



Recommended Utensils:

- Low rack
- Aluminum foil container
- Heat resistant cookware
- High rack
- Baking-tin

Before cooking, see "Helpful Hints", "NOTES" and "WARNING" on page E-13.





(1) To Cook without Preheating

* Suppose you want to cook for 20 minutes at 180°C.

Step	Procedure
1	Select convection temperature by pressing the OVEN pad (for 180°C press five times). 
2	Enter desired cooking time. 
3	Press the START pad.  The timer begins to count down to zero.

(2) To Cook with Preheating

* Suppose you want to preheat the oven to 200°C then cook for 20 minutes at 200°C.

Step	Procedure
1	Select preheat temperature by pressing the PREHEAT pad (for 200°C press 4 times). 
2	Press the OVEN pad once. 
3	Enter desired cooking time. 
4	Press the START pad.  PREHEAT will be displayed. When preheat is over, the oven will "beep" 4 times and ADD FOOD will be displayed.
5	Open the door. Place food in the oven. Close the door.
6	Press the START pad.  The timer begins to count down to zero.

MANUAL OPERATIONS

Helpful Hints:

1. Foods may be cooked either directly on turntable, or using the low rack.
2. Do not cover low rack with aluminum foil. It interferes with the flow of air that cooks food.

NOTES for CONVECTION COOKING:

1. After cooking the oven will automatically cool and the display will show NOW COOLING.
2. If you want to check the convection temperature during the cooking, press the OVEN pad.
As long as you press the OVEN pad, the temperature will appear on the display. You can check the actual temperature during preheating by pressing the OVEN pad.
This will not affect the oven operation.
3. Temperature measurements taken whilst the oven is in convection mode will differ from the displayed level. This is due to the grill elements turning on and off in order to regulate the oven temperature. This will not affect the cooking results as long as the operation manual and cook-book are followed correctly.

NOTES for PREHEATING:

1. When you set the preheat, the preset convection temperature will be automatically changed to the preheated temperature. After preheating, if you want to cook at a different temperature press the OVEN pad at step 2 until the desired setting appears on the display.
2. The preheated temperature will be maintained for 30 minutes. Once the oven door is opened, this function will be cancelled. After 30 minutes, preheat and the selected convection programme will be cancelled.

WARNING:

The door, outer cabinet, oven cavity, accessories, dishes and especially the grills will become very hot during operation. To prevent burns, always use thick oven gloves.

Mix Cooking

Mix cooking modes combines microwave power with convection or top grill. The combination of microwave power with convection or grill reduces cooking time and provides a crisp, brown finish.

Recommended Utensils:

- High rack
- Low rack
- Heat resistant cookware



Your oven has 4 Mix cooking modes. You cannot change the microwave power level. The convection temperature is preset with 250°C. You can change the convection temperature from 40°C to 250°C in ten levels. See NOTE 1 for MIX COOKING on page E-14.

Mix cooking Mode	Press MIX pad
Convec Mix High (Microwave 30% and Convection)	Once
Convec Mix Low (Microwave 10% and Convection)	Twice
Grill Mix High (Microwave 50% and Top Grill)	3 times
Grill Mix Low (Microwave 10% and Top Grill)	4 times

Before cooking, see "NOTES" and "WARNING" on page E-14.

(1) To cook by Mix Cooking

* Suppose you want to cook for 6 minutes on Grill Mix Low.

Step	Procedure
1	Select the MIX cooking mode by pressing the MIX pad (for Grill Mix Low press the MIX pad 4 times). 
2	Enter desired cooking time. 
3	Press the START pad.  The timer begins to count down.

MANUAL OPERATIONS

(2) To Cook by Convec Mix with Preheating

* Suppose you want to preheat the oven to 250°C and cook for 20 minutes on Convec Mix High.

Step	Procedure
1	Select preheat temperature by pressing the PREHEAT pad as required (for 250°C press once).  x 1
2	Select the Mix cooking mode by pressing the MIX pad (for Convec Mix High press once).  x 1
3	Enter desired cooking time.  x 2
4	Press the START pad.  PREHEAT will be displayed repeatedly. When preheat is over, the oven will "beep" 4 times and ADD FOOD will be displayed.
5	Open the door. Place food in oven. Close the door.
6	Press the START pad.  The timer begins to count down to zero.

NOTES for MIX COOKING:

- If you want to change convection temperature, press the OVEN pad until the desired temperature appears in the display after setting Convec Mix mode at step 1 and continue step 2.
- After cooking the oven will automatically cool and the display will show NOW COOLING.
- If you want to check the convection temperature during the cooking, press the OVEN pad.
As long as you press the OVEN pad, the temperature will appear on the display. You can check the actual temperature during preheating by pressing the OVEN pad. This will not affect the oven operation.
- Temperature measurements taken whilst the oven is in convection mode will differ from the displayed level.
This is due to the grill elements turning on and off in order to regulate the oven temperature. This will not affect the cooking results as long as the operation manual and cookbook are followed correctly.

NOTES for PREHEATING:

- When you set the preheat, the preset convection temperature will be automatically changed to the preheated temperature. After preheating, if you want to change Mix cooking mode(see Page E-13), press the MIX pad at step 2 until the desired setting appears on the display.
- The preheated temperature will be maintained for 30 minutes. Once the oven door is opened, this function will be cancelled. After 30 minutes, preheat and the selected convection programme will be cancelled.

WARNING:

The door, outer cabinet, oven cavity, accessories, dishes and especially the grills will become very hot during operation. To prevent burns, always use thick oven gloves.

AUTOMATIC OPERATIONS

Notes for Automatic Operations

Automatic Operations include the following features :-

- AUTO GRILL - AUTO RICE - AUTO ROAST
- AUTO REHEAT - AUTO BAKE - AUTO STEAM
- EASY DEFROST - CRISPY REHEAT - NONOIL FRY

1. More or less than the quantity or weight of foods suggested in each MENU GUIDE is programmed when the START pad is pressed. To clear, press the STOP/CLEAR pad and reprogramme.
2. When using the automatic features, carefully follow the details provided in each MENU GUIDE to achieve the best result. If the details are not followed carefully, the food may be overcooked or undercooked or "ERROR" may be displayed.
3. Food weighing more or less than the quantity or weight listed in each MENU GUIDE, cook manually.
4. When entering the weight of the food, round off the weight to the nearest 0.1kg (100g). For example, 0.35kg would become 0.4kg. If the DOWN (▼) weight pad is pressed the display will count down from the highest weight/quantity each time the pad is pressed. If the UP (▲) weight pad is pressed the display will count up from the lowest weight/quantity each time the pad is pressed.
5. When action is required (e.g. to turn food over) the oven stops and the audible signals sound. To continue cooking, press the START pad.
6. To change the final cooking or defrosting result from the standard setting, press the MORE (▲) (PLUS) or LESS (▼) (LESS) TIME pad prior to pressing the START pad. See page E-16.
7. The final cooking result will vary according to the food condition (e.g. initial temperature, shape, quality). Check the food after cooking and if necessary continue cooking manually.

WARNING :





The door, outer cabinet, oven cavity, accessories, dishes and especially the grills will become very hot during operation. To prevent burns, always use thick oven gloves.

How to Use Automatic Operations

Automatic Operations will automatically compute the cooking mode and cooking time.

(Follow the details provided in each Menu Guide on pages E-25-35.)

* Suppose you want to cook 0.6 kg of Steak.

Step	Procedure
1	Select the menu by pressing the desired pad (for Steak press the AUTO GRILL pad 3 times).  x 3
2	Press the WEIGHT pads to enter quantity.  x1 or x5
3	Press the START pad.  The cooking time will begin counting down. When the audible signals sound, the oven will stop and TURN OVER will be displayed.
4	Open the door. Turn over the meat. Close the door. Press the START pad.  The cooking time will continue counting down to zero. When it reaches zero, an audible signal will sound.

NOTE FOR EASY DEFROST:

Always press the EASY DEFROST pad only once at step 1.

NOTE FOR PREHEAT:

After pressing the AUTO BAKE pad (once, twice, or three times) and the START pad, PREHEAT will start automatically at step 3. When preheat is over, the oven will "beep" 4 times and ADD FOOD will be displayed.

NOTE FOR WEIGHT:

Only the menu of NONOIL FRY, Auto Grill, and Auto Roast will display ENTER WEIGHT at step 2. Skip the step 2 except the above.

OTHER CONVENIENT FEATURES

Less/More Setting





To adjust the cooking time to your individual preference - use the "more" or "less" feature to either add (more) or reduce (less) cooking time.

The LESS/MORETIME pads can be used to adjust the cooking time of the following features:-

- AUTO GRILL - AUTO REHEAT - AUTO RICE
- AUTO BAKE - NONOIL FRY - CRISPY REHEAT
- AUTO STEAM MENU - AUTO ROAST
- EASY DEFROST

To adjust cooking time, press the LESS (▼) or MORE (▲) TIME pad before pressing the START pad.





* Suppose you want to defrost 1.0 kg Roast Lamb for a longer time.

Step	Procedure
1	Press the EASY DEFROST pad. 
2	Press WEIGHT pads to enter weight.  x11 or x10
3	Press the MORETIME pad once.  x 1
4	Press the START pad. 

Adjust Time During Cooking

Cooking time can be added or decreased during a manual cooking programme using the "MORE (▲)" or "LESS (▼)" TIME pads.

* Suppose you want to increase cooking time by 2 minutes during 5 minutes on 50% (MEDIUM power) cooking.

Step	Procedure
1	Select power level by pressing the MICRO POWER pad as required. (for 50% press three times)  x 3
2	Enter desired cooking time.  x 5
3	Press the START pad.  The timer starts to count down.
4	Press the MORETIME pad twice to increase time by two minutes.  x 2

NOTE:

SLOW COOK cannot use this function.









OTHER CONVENIENT FEATURES

Help Feature (INFO)

(1) Auto Start

The Auto Start feature allows you to set your oven to start automatically only when clock is set. Auto Start can be used for manual cooking, SLOW COOK and AUTO RICE.

* Suppose you want to start cooking a casserole for 20 minutes on 50% (MEDIUM power) at 4:30 in the afternoon. (Check that the correct time of day is displayed.)

Step	Procedure
1	Press the INFO pad twice.  x 2
2	Enter the desired start time.  x 4
3	Press the CLOCK pad. 
4	Enter the desired start time.  x 3
5	Press the CLOCK pad. 
6	Set the desired cooking mode. (for microwave cooking on 50%, press the MICRO POWER pad 3 times) 
7	Enter the desired cooking time.  x 2
8	Press the START pad. 

NOTES:

- To check the current time, simply press the CLOCK pad, the time will be displayed.
- If the door is opened after step 8, close the door and press the START pad to continue with Auto Start.
- Press the STOP/CLEAR pad once to cancel Auto Start.
- The correct time of day must be set before using Auto Start, see clock setting on page E-6.

(2) Child Lock

If the oven is accidentally started with no food/liquid in the cavity, the oven could be damaged.

To prevent accidents like this, your oven has a "Child Lock" feature that you can set when the oven is not in use.

To set the Child Lock, press the INFO pad three times and press the START pad. LOCK will appear in the display.

The Control Panel is now locked and current time is shown in Clock Set Mode, and ". 0" is shown in Energy Save Mode. Each time a pad is pressed, the display will show LOCK.

To unlock the control panel, press the INFO pad, and the START pad. The display will show LOCK OFF at the same time. The time of day will be displayed and the oven is ready to use.

(3) Demonstration Mode

This feature is mainly for use by retail outlets, and also allows you to practice the key operation.

To demonstrate, press the INFO pad four times and press the START pad and hold for 3 seconds. DEMO MICROWAVE OVEN will appear in the display in both of Clock Set Mode and Energy Save Mode. Cooking operations can now be demonstrated with no power in the oven. For example, press START pad, and the display will show "1.00" and count down to zero at ten times the speed faster than normal. When the timer reaches zero, "0" will appear in the display.

To cancel, press the INFO pad four times and the START pad. Once, the display will show DEMO OFF.

(4) Language

The oven comes set for English. You can change the language to Malay by pressing the INFO pad 5 times. Then, press START pad.

(5) Help

Each setting of Automatic Operations and Slow Cook has a cooking hint.

If you wish to check, press the INFO pad whenever HELP is lighted in the display.

Alarm

Your oven has an alarm function. If you leave food in the oven after cooking, the oven will "beep" 3 times after 2 minutes.

If you do not remove the food at that time, the oven will "beep" 3 times after 4 minutes and 6 minutes.

CARE AND CLEANING

IMPORTANT:

Disconnect the power supply cord before cleaning or leave the door open to inactivate the oven during cleaning. Before cleaning, make sure the oven door, outer cabinet, oven cavity and accessories are completely cool.

CLEAN THE OVEN AT REGULAR INTERVALS - Keep the oven clean and remove any food deposits, or it could lead to deterioration of the surface. This could adversely affect the life of the appliance and possibly result in a hazardous situation.

Exterior:

The outside may be cleaned with mild soap and warm water, wipe clean with a damp cloth. Avoid the use of harsh abrasive cleaners. Keep the ventilation openings free of dust.

Door:

Wipe the door and window on both sides, the door seals and adjacent parts frequently with a damp cloth to remove any spills or splatters. Do not use harsh abrasive cleaners or sharp metal scrapers to clean the oven door glass since they can scratch the surface, which may result in shattering of the glass.

Touch Control Panel:

Wipe the panel with a cloth dampened slightly with water only. Do not scrub or use any sort of chemical cleaners. Avoid the use of excess water.

Interior walls:

Wipe splatters and spills with a little dishwashing liquid on a soft damp cloth. For heavier stains inside the oven cavity only, use a mild stainless steel cleaner applied with a soft damp cloth. Do not apply to the inside of the door. Wipe clean ensuring all cleaner is removed. After use, wipe the waveguide cover in the oven with a soft damp cloth to remove any food splashes. Built-up splashes may overheat and begin to smoke or catch fire. Do not remove the waveguide cover. **DO NOT USE CAUSTIC CLEANERS, ABRASIVE OR HARSH CLEANERS OR SCOURING PADS ON YOUR OVEN. NEVER SPRAY OVEN CLEANERS DIRECTLY ONTO ANY PART OF YOUR OVEN. DO NOT USE A STEAM CLEANER.** Avoid using excess water. After cleaning the oven, ensure any water is removed with a soft cloth.

NOTE:

At regular intervals, heat the oven referring to "Heating without Food" on page E-6. Because, the splashed dirt or food oil remained around oven walls may cause the smoke and odour.

Accessories:

Wash with mild soapy water and dry thoroughly.

NOTE:

Keep the waveguide cover and accessories clean at all times. If you leave grease or fat in the cavity or accessories, it may overheat, cause arcing, smoke or even catch fire when next using the oven.

SERVICE CALL CHECK

Check the following before calling service:

1. Does the display light? Yes _____ No _____
2. When the door is opened, is the oven lamp switched on? Yes _____ No _____
3. Place one cup of water (approx. 250 ml) in a glass measure in the oven and close the door securely.
Oven lamp should go off if door is closed properly.
Programme the oven for one minute on 100% (HIGH). At this moment:
 - A. Does the oven lamp light? Yes _____ No _____
 - B. Does the cooling fan work? Yes _____ No _____
(Put your hand over the rear ventilation openings.)
 - C. Does the turntable rotate? Yes _____ No _____
(The turntable can rotate clockwise or counterclockwise. This is quite normal.)
 - D. Do the microwave symbol and COOK indicator light? Yes _____ No _____
 - E. After one minute, did an audible signal sound? Yes _____ No _____
 - F. Is the water inside the oven hot? Yes _____ No _____
4. Remove water from the oven and programme the oven for 3 minutes on GRILL mode using top and bottom grills.
 - A. Do the top and bottom grill symbols and COOK indicator light? Yes _____ No _____
 - B. After 3 minutes, do the both grills become red? Yes _____ No _____

If "NO" is the answer to any of the above questions, please check your wall socket and the fuse in your meter box. If both the wall socket and the fuse are functioning properly, CONTACT YOUR NEAREST SERVICE CENTRE APPROVED BY SHARP.

IMPORTANT: If the display shows nothing even if the power supply plug is properly connected, the Energy Save Mode may be in operation. Open and close the oven door to operate the oven. See "Getting Started" on page E-6.

- NOTE:**
1. If time in the display is counting down very rapidly, check Demonstration Mode.
(Please see page E-17 for detail.)
 2. The following thing is not trouble;
Each cooking mode has a maximum cooking time. If you operate the oven longer than the maximum time, the power will automatically be reduced. The table below shows the maximum time for each cooking mode.

Cooking mode	Maximum cooking time
Microwave 100% cooking	20 min.
Grill cooking Top grill	15 min.
Bottom grill	15 min.
Top and bottom grill	Top grill 6 min. Bottom grill 6 min.
MIX cooking / Grill Mix-Low	15 min.

SPECIFICATIONS

AC Line Voltage	: Refer to the rating label.
AC Power Required	:
Microwave	1.45kW
Grill	1.15kW (Top Grill) 0.6kW (Bottom Grill) 1.7kW (Top and bottom Grill)
Convection	1.71kW
Output Power	:
Microwave	0.90kW* (IEC test procedure)
Grill Heater	1.1kW (Top Grill) 0.55kW (Bottom Grill) 1.65kW (Top and bottom Grill)
Convection	1.65kW
Microwave Frequency	: 2450 MHz** (Class B/Group 2)
Outside Dimensions	: 520 mm(W) x 309 mm(H) x 486 mm(D)****
Cavity Dimensions	: 343 mm(W) x 209 mm(H) x 357 mm(D)***
Oven Capacity	: 26 litre***
Cooking Uniformity	: Turntable (325 mm in diameter) system
Weight	: Approx. 19kg

* This measurement is based on the International Electrotechnical Commission's standardised method for measuring output power.

** This is the classification of ISM (Industrial, Scientific and Medical) equipment described in the International Standard CISPR11.

*** Internal capacity is calculated by measuring maximum width, depth and height.
Actual capacity for holding food is less.

**** The depth does not include the door opening handle.

COOKING GUIDES

Microwave Cooking Techniques

<u>Arrange food carefully</u>	Place the thickest areas toward outside of dish.
<u>Watch cooking time</u>	Cook for the shortest amount of time indicated and add more time as needed. Food severely overcooked can smoke or ignite.
<u>Cover foods before cooking</u>	Check recipe for suggestions: paper towels, microwave plastic wrap or a lid. Covers prevent spattering and help foods to cook evenly. (Helps keep oven clean)
<u>Shield foods</u>	Use small pieces of aluminium foil to cover thin areas of meat or poultry in order to avoid overcooking.
<u>Stir foods</u>	From outside to center of dish once or twice during cooking, if possible.
<u>Turn foods</u>	Foods such as chicken, hamburgers or steaks should be turned over once during cooking.
<u>Rearrange foods</u>	Like meatballs halfway through cooking both from top to bottom and from the center of the dish to the outside.
<u>Allow standing time</u>	After cooking ensure adequate standing time. Remove food from oven and stir if possible. Cover during standing time can allow the food to finish cooking completely.
<u>Check for doneness</u>	Look for signs indicating that cooking temperature has been reached. Doneness signs include: <ul style="list-style-type: none"> - Steam emits throughout the food, not just at edge; - Joints of poultry can be torn apart easily; - Pork and poultry show no pinkness; - Fish is opaque and flakes easily with a fork.
<u>Condensation</u>	A normal part of microwave cooking. The humidity and moisture in food will influence the amount of moisture in the oven. Generally, covered foods will not cause as much condensation as uncovered foods. Ensure that the ventilation openings are not blocked.
<u>Browning dish</u>	When using a browning dish or self-heating material, always place a heat-resistant insulator such as a porcelain plate under it to prevent damage to the turntable and Turntable motor shaft due to heat stress. The preheating time specified in the dish's instructions must not be exceeded.
<u>Microwave safe plastic wrap</u>	For cooking food with high fat content, do not bring the wrap in contact with the food as it may melt.
<u>Microwave safe plastic cookware</u>	Some microwave safe plastic cookware are not suitable for cooking foods with high fat and sugar content.

Grill and Grill Mix Recipes

Spare Ribs

[Ingredients]

1 kg pork spare ribs
3 tbsp. corn oil

[Seasonings]

3 tbsp. light soy sauce
3 tbsp. water
2 tbsp. hoisin sauce
3 tbsp. dry sherry or wine
5 tbsp. pork broth
Salt, sugar, chopped garlic to taste

[Method]

1. Blanch the spare ribs in boiling water for 2 minutes. Then rinse.
2. Marinate ribs for 20 minutes with seasonings.
3. Place on the low rack and brush with oil.
4. Let them roast.

Mode	Cooking time	Microwave Power	Procedure
1st Microwave	4'-6'	MED HIGH	Turn over
2nd Grill Mix High	7'-9'	MED	
3rd Microwave	4'-6'		
4th Grill Mix High	5'-6'		

5. Garnish with pickles and pineapple.

Chinese Roast Pork

[Ingredients]

0.9 kg pork loaf

[Seasonings]

5 tbsp. barbecue pork sauce or
1/2 tsp. char siew coloring, blended with
1 1/2 tbsp. water
1 tsp. salt
12 tbsp. sugar
1 tbsp. light soy sauce
1 tbsp. dark soy sauce
2 tbsp. corn oil

[Glazing]

2 tbsp. honey

[Method]

1. Wash pork clean and pat dry. Bind with thread.
2. Marinate with seasonings for 2 to 3 hours.
3. Set the pork on low rack.
4. Let it grill.

Mode	Cooking time	Microwave Power	Procedure
1st Microwave	13'-15'	MED HIGH	Turn over
2nd Grill Mix High	13'-17'		
3rd Grill Mix High	8'-10'		

5. Brush with honey 2 - 3 minutes before finish.
6. After grill let stand for 10 minutes.

Pork Steaks with Onion Sauce

[Ingredients]

650 g pork chop
1/2 onion, sliced
1 tomato, sliced
1 tbsp. oil
Black pepper, Honey to taste

[Seasonings]

1 tbsp. light soy sauce
1 tsp. dark soy sauce
2 tsp. sugar
1 tsp. wine
1 tsp. oil
Salt and pepper to taste

[Gravy]

1 tbsp. oyster sauce
1 tsp. sugar
1 grated garlic
1 tsp. oil
70 ml water
Salt to taste
2 tsp. cornflour blended with 1 tbsp. water

[Method]

1. Wash pork and pat dry.
2. Marinate pork with seasonings for 30 minutes.
3. Sprinkle black pepper on marinated pork, then cook on the high rack.

Mode	Cooking time	Microwave Power	Procedure
1st Grill Mix-High	5'30"	HIGH	Brush honey and turn over
2nd Grill (Bottom grill)	5'		
3rd Microwave (Top grill)	7'-9'		
4th Microwave	3'-4'		

4. Combine onion and oil; cover, microwave on 100% (HIGH) for 2-3 minutes.
5. Add gravy, except blended cornflour; microwave on 100% (HIGH) for 1 minute; remove, stir and continue to cook another 1 minute.
6. Add tomato; cover and microwave on 100% (HIGH) for 30 seconds.
7. Add blended cornflour to boiled seasonings; stir until cornflour is thick.
8. Top sliced pork with prepared gravy and garnish with spring onion.

Grilled Duck

[Ingredients]

1 duck (approx. 900 g)
salt, pepper
paprika
oil

[Method]

1. Season breast cavity with salt and pepper.
2. Stir together oil and paprika and rub over outside of duck.
3. Place on the low rack and press MIX pad 3 times to Grill Mix High. Cook for 16-20 minutes. Turn over halfway through cooking.
4. Cover with foil and let stand 5 - 10 minutes before serving.

Pork and Prawn Kebabs

[Ingredients]

300 g pork, cut into 24 square pcs.
100 g onion, cut into 12 square pcs.
80 g green pepper, cut into 12 square pcs.
80 g tomato, cut into 12 square pcs.
70 g prawns, shelled and deveined then cut into 3 pcs.

[Seasonings]

2 tbsp. corn oil
1 1/2 tsp. salt
1/2 tsp. pepper
1 tsp. paprika
1/2 tsp. garlic powder

[Glazing]

3 tbsp. melted butter
1 tbsp. lemon juice

[Method]

1. Marinate prepared ingredients with blended seasonings for more than 30 minutes.
2. Skewer a variety of ingredients onto bamboo sticks alternately with pork, tomato, prawn, onion, and green pepper, then glaze with melted butter and lemon juice.
3. Place on the high rack and press MIX pad 3 times to Grill Mix High. Cook for 7-10 minutes. Turn over halfway through cooking.
4. Serve hot.

Grilled Pigeon

[Ingredients]

1 pigeon (approx. 300g)

[Seasonings]

1 tbsp. light soy sauce
1 tsp. dark soy sauce
1 tbsp. oil
1/2 tsp. salt
1 tsp. sugar
1 tsp. ginger juice
1 tsp. cooking wine

[Method]

1. Bind wings and legs of pigeon with string.
2. Marinate pigeon for at least 10 minutes.
3. Place on the low rack and press MIX pad 3 times to Grill Mix High. Cook for 7-11 minutes. Turn over halfway through cooking.

Chinese Pizza

[Ingredients]

200g plain flour
1/2 tsp. yeast
1 tsp. baking powder
40g sugar
few alkaline water
few sesame seeds

[Method]

1. Dissolve yeast in water, then mix with flour and add enough water to form a dough. Let stand and rise.
2. Add in the remaining ingredients(except sesame seeds) and mix the dough again, then roll into a 10-inches flat round shape.
3. Brush oil and place sesame seeds sparingly on top of it. Put the pizza onto an oil-brushed turntable and cook at Grill (Bottom Grill) for 5'00", then at Double Grill (Top and Bottom Grill) for 3'00".
4. Turnover, brush oil on pizza top and cook again at Grill (Bottom Grill) for 4'30".

Beef Steak with Vegetable Sauce

[Ingredients]

510g beef, (about 1 cm thick)
1/2 onion (sliced)
1 tomato (sliced)
2 cloves garlic (chopped)
1 tbsp. oil

[Seasonings]

1 tbsp. light soy sauce
1 tbsp. dark soy sauce
1 tbsp. chopped ginger
1 tsp. sugar
1 tsp. wine
1/2 tsp. salt
2 tbsp. oil
1/2 tsp. garlic powder
1 tsp. pepper

[Gravy]

2 tbsp. tomato sauce
2 tsp. sugar
1/2 tsp. salt
1 tsp. vinegar
5 tbsp. water
2 tsp. cornflour blended with 1 tbsp. water

Crispy Stuffed Mushrooms

[Ingredients]

12 Black mushrooms
75g butter
2 cloves garlic (crushed)
75g fresh breadcrumbs
50g cheese (grated)

Baked Avocados with Ham

[Ingredients]

50g butter
50g fresh brown breadcrumbs
100g cooked ham (finely chopped)
90ml double cream
salt and pepper to taste
1 tsp. fresh parsley (chopped)
2 large ripe avocados
1 tbsp. lemon juice
50g cheese (grated)

[Method]

(Beef Steak)

1. Wash beef and pat dry.
2. Marinate beef with seasonings for 20 minutes.
3. Place on the low rack. Brush with oil. Let it roast.

Mode	Cooking time	Procedure
1st Grill Mix High	12'-14'	Turn over
2nd Grill Mix High	5'-6'	

4. Wrap the roasted beef with aluminum foil; let it stand for 10 minutes.

(Vegetable Sauce)

1. Place onion, garlic and oil in a casserole and cover; microwave on 100% (HIGH) for 2'20" - 3'20".
2. Add gravy, (except blended cornflour); cover; microwave on 100% (HIGH) for 50 seconds.; remove, stir and continue to cook for 50 seconds.
3. Add tomato; cover and microwave on 100% (HIGH) for 30 seconds.
4. Add blended cornflour into boiled seasonings, stir until cornflour is thick.
5. Top sliced beef with prepared gravy and garnish with shiso leaves.

[Method]

1. Soak the mushrooms until soften, then remove and chop mushroom stalks.
2. Heat butter with garlic on 100% (HIGH) for 50 seconds, stir in chopped mushroom stalks and breadcrumbs. Fill mushrooms with mixture, sprinkle with cheese.
3. Place the mushrooms on a dish and place on the high rack. Press MIX pad 3 times to Grill Mix High and cook for 4'40"-5'40".

[Method]

1. Place the butter in a bowl and heat on 100% (HIGH) for 50 seconds. Stir in the breadcrumbs and ham, add enough cream to bind the mixture. Season with salt and pepper to taste and stir in the parsley, cook on 100% (HIGH) for 1'40"-2'40".
2. Cut the avocados in half, remove the stone and brush the flesh with lemon juice. Fill each avocado half with the breadcrumb mixture.
3. Place the avocados in a large flan dish and sprinkle with the grated cheese.
4. Place the dish on the high rack, cook on 100% (HIGH) for 50 seconds, then on GRILL (Top Grill) for 6-7 minutes until brown and crispy.

Fish Kebabs

[Ingredients]

4 wooden skewers
450g firm fleshed fish (skinned and cut into 8 cubes)
2 courgettes, cut into 8 chunks
4 medium mushrooms (stalks removed)
4 slices of orange
2 medium tomatoes (halved)
1 tsp. fresh dill (chopped)
50g butter

Chicken Satay

[Ingredients]

4 wooden skewers
450g chicken fillets (cubed)

[Seasonings]

1 tbsp. groundnut oil
1 tbsp. lemon juice
2 tbsp. satay sauce
1 clove garlic (crushed)
Tabasco sauce to taste

Vegetable Loaf

[Ingredients]

(A)

175g fresh breadcrumbs
1 large carrot (grated)
2 small courgettes (sliced)
1 large potato (grated)
3 sticks of celery (sliced)
4 rashers bacon (chopped)
125g Cheddar cheese (grated)
2 eggs (beaten)
salt and pepper to taste

(B)

75g Cheddar cheese (grated to sprinkle)
1 tbsp. fresh parsley (chopped)

Green Onion Cake

[Ingredients]

200g plain flour
around 100ml hot water
2 stalks green onion dices
few castor salt
few tbsps. oil

[Method]

1. Arrange all ingredients onto each skewer in a regular sequence. Leave no wood exposed.
2. Heat the dill and butter in a small bowl on 100% (HIGH) for 1 minute. Brush kebabs with the dill butter, place in a flan dish on the high rack.
3. Press MIX pad 3 times to Grill Mix High and cook for 11-13 minutes. Turn over and rearrange the kebabs every 3 minutes.

(NOTE: To remove food easily from wooden skewers, soak the skewers in water for 30 minutes prior to using them.)

[Method]

1. Place all the seasonings in a large bowl, mix well. Stir in the chicken, refrigerate for 2 hours to marinate.
2. Thread the chicken onto skewers leaving no wood exposed. Place in a large flan dish on the high rack. Press MIX pad 3 times to Grill Mix High and cook for 10'30" - 12'00". Turn over and rearrange skewers every 3 minutes.

(NOTE: To remove food easily from wooden skewers, soak the skewers in water for 30 minutes prior to using them.)

[Method]

1. Combine (A), mix well.
2. Pour mixture into a greased 1.5 litre loaf dish, cover with (B).
3. Place on turntable, cook on 50% (MEDIUM) for 15-16 minutes. Then press MIX pad 3 times to Grill Mix High and cook for 6 - 8 minutes.

[Method]

1. Mix flour with hot water to form a dough. Roll out the dough into a flat, long rectangular sheet.
2. Brush oil on dough, then place green onion dices on top and sprinkle sparingly with castor salt.
3. Hold up from one end and roll along from Right to Left to form a short roll shape. Trim and press both ends of openings, then roll on top of ends to form a flat round cake shape.
4. Brush oil on top of the cake. Put it onto an oil-brushed turntable and cook at Grill (Bottom Grill) for 5'00", then at Double Grill (Top and Bottom Grill) for 6'00". Turnover, brush oil on the cake and cook again at Grill (Bottom Grill) for 5'00".

Auto Grill Menu Guide

Menu No.	Menu	Initial Temperature	Weight (KG)	Procedure
AG-1	Grill Fish eg: Pomfret Golden Thread Mackerel Snapper etc.	8 - 12°C	0.1 - 0.4kg	<ul style="list-style-type: none"> Wash fish thoroughly and remove scales. Make a few slits on the skin of fish, pierce the eyes of fish. Pat dry, then brush oil on fish body. Place on the high rack (brushed lightly with oil), uncovered. When oven stops, turn it over. Continue to cook.
AG-2	Grill Lobster NOTE <ul style="list-style-type: none"> The tail of lobsters should be made "flat" as much as possible to avoid getting burnt. Lobsters should be fresh, otherwise there will be much "juice" came out during and after cooking. Lobsters should be transferred to another plate after cooking as the cheese might melt and spread around the plate, making it messy and not presentable when serve. 	10 - 14°C	0.1 - 0.6kg 1 lobster, Regular size: 360g to 600g Small size (LESS) 240g to 360g	<ul style="list-style-type: none"> Cut the whole lobster into 2 halves. Wash the lobster halves and remove all substances inside its head. Sprinkle little cornflour over surface of lobster's body. Slice cheese in about 1 cm thickness and cover the top of lobster with the cheese. Place on a ceramic plate, then on the high rack. Cook uncovered. ½ (1pc) or 1 (2pcs) lobster can be cooked each time. But whenever small size of lobster is cooked, make sure the (▼) LESS TIME pad is entered for best results.
AG-3	Steak (Beef Steak)	8 - 12°C	0.2 - 0.6kg	<ul style="list-style-type: none"> Steak is recommended to have a thickness of about 1.5 cm to get good result. Season as desired. Place on the high rack. When oven stops, turn steak over. After cooking, stand. Serve with hot sauce where necessary.

Auto Rice Menu Guide

Menu No.	Menu	Quantity	Procedure							
R-1	Rice	1 - 2 serves	<ul style="list-style-type: none"> Wash rice until water runs clear. Place rice and water into a deep casserole (about 2ℓ) and soak for 30 mins (stir rice a few times during soaking). Stir and cook with cover. After cooking, stir lightly and stand for 5 mins with a cover. 							
	<table border="1"> <thead> <tr> <th>Serving (s)</th> <th>Rice</th> <th>Water</th> </tr> </thead> <tbody> <tr> <td>1 serve (1-2 persons)</td> <td>150g</td> <td>250ml</td> </tr> <tr> <td>2 serves (3-5 persons)</td> <td>300g</td> <td>480ml</td> </tr> </tbody> </table>	Serving (s)		Rice	Water	1 serve (1-2 persons)	150g	250ml	2 serves (3-5 persons)	300g
Serving (s)	Rice	Water								
1 serve (1-2 persons)	150g	250ml								
2 serves (3-5 persons)	300g	480ml								
R-2	Congee	1 - 2 serves	<ul style="list-style-type: none"> Wash rice until water runs clear. Place rice and water into a deep casserole (about 2ℓ) and soak for 30 mins (stir rice a few times during soaking). Stir and cook uncovered. After cooking, stir and stand. 							
	<table border="1"> <thead> <tr> <th>Serving (s)</th> <th>Rice</th> <th>Water</th> </tr> </thead> <tbody> <tr> <td>1 serve (1-2 persons)</td> <td>50g</td> <td>750ml</td> </tr> <tr> <td>2 serves (3-5 persons)</td> <td>80g</td> <td>1400ml</td> </tr> </tbody> </table> <p>Menu Variation</p> <p>eg * Congee with Pallock Fish and Peanuts Ingredients: 100g Pallock fish (fried; chopped) (3-5 persons) 50g Peanuts 1 slice Salted Turnip (chopped) 3 Spring onions (chopped)</p> <p>NOTE The ingredients can be added just <u>after finish</u>, with Salted Turnip and Spring onions as garnish and sprinkles on top.</p> <p>* Congee with salted pork and preserved duck eggs Ingredients: approx. 230g ($\frac{1}{2}$ ℓ) cooked lean pork (chopped) (3-5 persons) 2 preserved duck eggs (diced)</p> <p>NOTE The ingredients can be added 10 min. <u>before finish</u>.</p>	Serving (s)		Rice	Water	1 serve (1-2 persons)	50g	750ml	2 serves (3-5 persons)	80g
Serving (s)	Rice	Water								
1 serve (1-2 persons)	50g	750ml								
2 serves (3-5 persons)	80g	1400ml								
R-3	Porridge	1 - 2 serves	<ul style="list-style-type: none"> Wash rice until water runs clear. Place rice and water into a deep casserole (2ℓ for 1 serve, 3ℓ for 2 serves) and soak for 15 mins (stir rice a few times during soaking). Stir and cook uncovered. After cooking, stir and stand. 							
	<table border="1"> <thead> <tr> <th>Serving (s)</th> <th>Rice</th> <th>Water</th> </tr> </thead> <tbody> <tr> <td>1 serve (1-2 persons)</td> <td>60g</td> <td>700ml</td> </tr> <tr> <td>2 serves (3-5 persons)</td> <td>140g</td> <td>1400ml</td> </tr> </tbody> </table> <p>Menu Variation</p> <p>You can enjoy the variation by putting some ingredients into Porridge just after finish or 10 mins before finish.</p> <p>eg * Chicken porridge: 200g Chicken (cut small pieces, precooked) (3-5 persons) spring onion, cut 3cm long</p> <p>* Fish porridge : 250g fish (precooked) (3-5 persons) 2 slices ginger (cut into stripes)</p>	Serving (s)		Rice	Water	1 serve (1-2 persons)	60g	700ml	2 serves (3-5 persons)	140g
Serving (s)	Rice	Water								
1 serve (1-2 persons)	60g	700ml								
2 serves (3-5 persons)	140g	1400ml								

- NOTE**
1. Water temperature should be about 20°C at initial cooking.
 2. 1 tael=38 grams.

Auto Roast Menu Guide

Menu No.	Menu	Initial Temperature	Weight (KG)	Procedure
AR-1	<p>Beef</p> <p>* You can adjust doneness by pressing the time pad: — ▲(MORE) — Well done ▼(LESS) — Rare</p> <p>NOTE If seasonings are used prior to cooking, a well-cooked doneness may be resulted.</p>	8 - 12°C	1.0 - 1.6kg	<ul style="list-style-type: none"> Place in centre of low rack, uncovered. When oven has stopped, turn beef over and shield the well cooked portions where necessary. (Note: Make sure the foil does not touch each other and the oven wall.) After cooking, stand for 10-15 minutes.
AR-2	<p>Lamb</p> <p>* You can adjust doneness by pressing the time pad: — ▲(MORE) ▼(LESS) — Cannot be used and ERROR will be displayed.</p> <p>NOTE If seasonings are used prior to cooking, a well-cooked doneness may be resulted.</p>	8 - 12°C	1.0 - 1.6kg	<ul style="list-style-type: none"> Place in centre of low rack, uncovered. When oven has stopped, turn lamb over and shield the well cooked portions where necessary. (Note: Make sure the foil does not touch each other and the oven wall.) After cooking, stand for 10-15 minutes.
AR-3	<p>Chicken</p> <p>eg: Whole chicken Half chicken</p> <p>* You can adjust doneness by pressing the time pad ▲(MORE) or ▼(LESS).</p> <p>NOTE If the chicken has just been defrosted, make sure it has stood for at least 6 hours at room temperature and defrosted completely before roasting.</p>	8 - 12°C	1.0 - 1.6kg	<ul style="list-style-type: none"> Wash chicken, trim away fat and pat dry. Season as desired for at least 30 mins. Place on the low rack, uncovered. When oven stops, cover thinner part or end of legs with foil. (Discard excess oil on the turntable where necessary.) Turn it over and continue to cook. (Note: Make sure the foil does not touch each other and the oven wall.) After cooking, stand for 10-15 mins.

Auto Reheat Menu Guide

Menu	Initial Temperature	Quantity	Procedure
Dish Lunch/Dinner plate Meat Dish Fried Noodles Plate of Rice	4-12°C Refrigerated temperature	1 serve (approx. 200g)	<ul style="list-style-type: none">• Take out the dish from the refrigerator.• Cover with microwave wrap or lid.• No need to enter quantity.• After reheating, stir and stand covered for 1 minute.

Auto Bake Menu Guide

Menu No.	Menu	Initial Temperature	Quantity	Procedure
AB-1	Cake (Plain cake)	20 - 25°C Room temperature	Make one 22 cm round cake	<ul style="list-style-type: none"> • Remove turntable before preheating. (Preheat is automatic for this menu.) • Prepare the cake as in the recipe on page E-30. • Place turntable with cake on the low rack in the oven after preheating. • After cooking, stand.
AB-2	Apple Pie	20 - 25°C Room temperature	Make one 22 cm round pie	<ul style="list-style-type: none"> • Remove turntable before preheating. (Preheat is automatic for this menu.) • Prepare the pie as in the recipe on page E-30. • Place turntable with pie in the oven after preheating. • After cooking, stand.
AB-3	Cookies (Chocolate chip cookies)	20 - 25°C Room temperature	1 layer (Make 13 cookies)	<ul style="list-style-type: none"> • Remove turntable before preheating. (Preheat is automatic for this menu.) • Prepare the cookies as in the recipe on page E-30. • Place turntable with cookies in the oven after preheating. • After cooking, stand.

Auto Bake Recipe

Plain Cake

[Ingredients]

180 g	self raising flour
1/2 tsp	baking powder
80ml	milk
120g	butter (soften)
120g	caster sugar
3	eggs

[Method]

1. Mix butter and sugar thoroughly until light and fluffy.
2. Add in beaten eggs and stir well.
3. Fold in self raising flour, baking powder and milk.
4. Pour into a 22cm round metal baking tin lined with wax paper.
5. Place on low rack and bake.

Apple Pie

[Ingredients]

(Filling)

5 (900g)	apples (medium)
60g	sugar
1 1/2 tbsp	plain flour
2 tsp	lemon juice
few	cinnamon
few	nutmeg

(Pastry)

360g	plain flour
60g	sugar
185g	butter
5 tbsp	cold water
1	egg white (lightly beaten)

[Method]

(Filling)

1. Peel off apple skins and discard apple cores. Cut the apples into cubes of 3 x 4cm.
2. Mix with other filling ingredients in casserole. Cover and cook at microwave 100% (HIGH) for 8 minutes or until apple is tender.
3. After cooking, stir and let stand until it cools off.

(Pastry)

1. Sift flour and mix with sugar. Rub in butter until mixture resembles fine breadcrumbs. Add in cold water sparingly to form a soft dough.
2. Wrap with greaseproof paper and refrigerate for 1 hour.
3. Roll out 2/3 of pastry on a 22cm bottom, 3cm high metal pie plate brushed with oil.
4. Spoon prepared filling into pastry case.
5. Roll out remaining pastry and cut into strips. Use pastry strips as braids and cover the top of pie. Press edges of pastry together; trim.
6. Brush egg white on pastry (pie top and edges). Place on turntable and bake.
7. After baking, serve with cream or ice cream when the pie cools off.

Chocolate Chip Cookies

[Ingredients]

60g	butter (soften)
100g	caster sugar
1/4 tsp	vanilla essence
1	egg (medium)
180g	self raising flour (sifted)
40g	chocolate chips
30g	walnut pieces

[Method]

1. Cream butter and sugar until light and fluffy. Beat in egg and vanilla essence.
2. Mix in sifted flour, then mix in chocolate chips and walnut pieces.
3. Shape 13 each tablespoonfuls of mixture into balls. Place directly on turntable lined with greased foil paper; press each down slightly with around 4cm in diameter. Allow room for spreading, then bake.
4. After baking, remove cookies from the oven immediately and let cool.

Auto Steam Menu Guide

Menu No.	Menu	Initial Temperature	Quantity	Procedure								
S-1	Fish eg: Sea Bream Red Snapper Carp Pomfret Golden Thread Black Mullet Flatfish Garoupa etc.	8-12°C	1 - 3 serves (Whole fish)	<ul style="list-style-type: none"> Wash fish thoroughly and remove scales. Make a few cuts on the skin of fish, pierce the eyes of fish. Put on a shallow dish, 22-28 cm in diameter. Sprinkle lightly with water, salt and oil. Put green onion and ginger slices on top. Cover with microwave wrap. After cooking, stand covered for 3-5 minutes. 								
	<table border="1" style="width: 100%; border-collapse: collapse;"> <thead> <tr> <th style="width: 50%;">Serving (s)</th> <th style="width: 50%;">Weight</th> </tr> </thead> <tbody> <tr> <td style="text-align: center;">1 serve</td> <td style="text-align: center;">130 - 199g</td> </tr> <tr> <td style="text-align: center;">2 serves</td> <td style="text-align: center;">200 - 300g</td> </tr> <tr> <td style="text-align: center;">3 serves</td> <td style="text-align: center;">301 - 420g</td> </tr> </tbody> </table>	Serving (s)	Weight		1 serve	130 - 199g	2 serves	200 - 300g	3 serves	301 - 420g		
	Serving (s)	Weight										
	1 serve	130 - 199g										
2 serves	200 - 300g											
3 serves	301 - 420g											
S-2	Meat eg: Pork patty Beef patty Spare rib cubes Chicken pieces etc.	8-12°C	1 - 3 serves	<ul style="list-style-type: none"> Marinate the meat. For meat patty, try to make it a thin layer. Put on a shallow dish, 22-31 cm in diameter. Cover with microwave wrap. After cooking, stand covered for 3-5 minutes. 								
	<table border="1" style="width: 100%; border-collapse: collapse;"> <thead> <tr> <th style="width: 50%;">Serving (s)</th> <th style="width: 50%;">Weight</th> </tr> </thead> <tbody> <tr> <td style="text-align: center;">1 serve</td> <td style="text-align: center;">180 - 249g</td> </tr> <tr> <td style="text-align: center;">2 serves</td> <td style="text-align: center;">250 - 400g</td> </tr> <tr> <td style="text-align: center;">3 serves</td> <td style="text-align: center;">401 - 520g</td> </tr> </tbody> </table>	Serving (s)	Weight		1 serve	180 - 249g	2 serves	250 - 400g	3 serves	401 - 520g		
	Serving (s)	Weight										
	1 serve	180 - 249g										
2 serves	250 - 400g											
3 serves	401 - 520g											
S-3	Dumpling 1. Ready-made (cooked)	8-12°C	1 - 2 serves	<ul style="list-style-type: none"> Arrange the dumplings from outside to inside of dish. Cover with microwave wrap. Place on the low rack. After cooking, stand covered for 1 minute. 								
	<table border="1" style="width: 100%; border-collapse: collapse;"> <thead> <tr> <th style="width: 50%;">Serving (s)</th> <th style="width: 50%;">Weight</th> </tr> </thead> <tbody> <tr> <td style="text-align: center;">1 serve</td> <td style="text-align: center;">100 - 199g</td> </tr> <tr> <td style="text-align: center;">2 serves</td> <td style="text-align: center;">200 - 370g</td> </tr> </tbody> </table>	Serving (s)	Weight		1 serve	100 - 199g	2 serves	200 - 370g				
	Serving (s)	Weight										
	1 serve	100 - 199g										
	2 serves	200 - 370g										
<table border="1" style="width: 100%; border-collapse: collapse;"> <thead> <tr> <th style="width: 50%;">Serving (s)</th> <th style="width: 50%;">Weight</th> </tr> </thead> <tbody> <tr> <td style="text-align: center;">1 serve</td> <td style="text-align: center;">100 - 199g</td> </tr> <tr> <td style="text-align: center;">2 serves</td> <td style="text-align: center;">200 - 370g</td> </tr> </tbody> </table>	Serving (s)	Weight	1 serve	100 - 199g	2 serves	200 - 370g						
Serving (s)	Weight											
1 serve	100 - 199g											
2 serves	200 - 370g											
<p>NOTE 1. Only the package that is microwave-recommended is allowed, otherwise, remove the package and transfer to a ceramic plate and cover.</p> <p>2. For the Shanghai Dumplings, more time may be required for steaming to soften the dough.</p> <p>3. Whenever necessary, dumplings can be cooked for a longer time manually.</p>												

NOTE See recipes in cookbook.

Crispy Reheat Menu Guide

Menu No.	Menu	Initial Temperature	Quantity	Procedure
CR-1	Frozen Fries Includes: Wedges Crinkle cut Shoe string	-18°C Frozen temperature	0.1-0.5kg	<ul style="list-style-type: none"> • Place directly onto turntable. • When oven stops and TURN FRIES, OVER is displayed, turn over fries and continue cooking
CR-2	Frozen Meat Pies	-18°C Frozen temperature	1-4 pieces (1 piece = 160-200g)	<ul style="list-style-type: none"> • Remove from package. • Place upside down directly onto turntable. • When oven stops and TURN, PIE OVER is displayed, turn over pies and continue cooking. • After cooking, stand.
CR-3	Frozen Pizza	-18°C Frozen temperature	0.2-0.5kg 1 pizza (base)	<ul style="list-style-type: none"> • Remove from package. • Place directly onto turntable.
CR-4	Frozen Finger Food Includes: Party pies Party sausage rolls Cocktail spring rolls Mini chicken drum sticks Sea shantys Chicken chippies, Calamari	-18°C Frozen temperature	0.2-0.5kg	<ul style="list-style-type: none"> • Remove from package. • Place directly onto turntable.

Nonoil Fry Menu Guide

Menu No.	Menu	Initial Temperature	Quantity	Procedure
NF-1	<p>Fried Chicken Wings</p> <p>Ingredients: 250-500g (6-12 pieces)</p> <p>Seasoning: (A) 1 tbsp. Soy Sauce 1 tsp. Salt</p>	<p>8-12°C</p> <p>Chicken Wings</p> <p>30g</p>	<p>250-500g (6-12 piece)</p> <p>Cornstarch</p>	<p>1. Marinate prepared ingredients with blended seasonings (A) for more than 10 minutes</p> <p>2. Put (1) and cornstarch into a plastic bag and mix it.</p> <p>3. After removing excess cornstarch, place on the low rack with the chicken skin's side up.</p> <p><Note> If the conr starch remains after finish, stand it for a while.</p>
NF-2	<p>Fish Fritters</p> <p>Ingredients: 250-500g (2-4serves)</p> <p>Seasoning: 2 Eggs 108g Flour 4 tbsp. Cornstarch</p>	<p>8-12°C</p> <p>Fillet of White Fish</p> <p>4 tbsp. Water 2 tbsp. Cheese (grated)</p>	<p>250-500g (2-4 serves)</p>	<p>1. Cut the fish into smaller pieces as fritter size</p> <p>2. Marinate (1) with blended seasonings</p> <p>3. Place on turntable with a cooking sheet to avoid sticking.</p> <p><Note> Add seasonings or dip with sauce as you like</p>
NF-3	<p>Potato Wedges</p> <p>Ingredients: 250-500g (2-4serves)</p> <p>Seasoning: 1 tbsp. Cheese (grated) 1 tsp. Salt 1/2 tsp. Pepper</p>	<p>8-12°C</p> <p>Potato</p> <p>1 tbsp. Paprika powder 1/2 tsp. Garlic powder 45g Oil</p>	<p>250-500g (2-4serves)</p>	<p>1. Cut potato into 8 wedges</p> <p>2. Marinate (1) with blended seasonings</p> <p>3. Place on turntable with a cooking sheet to avoid sticking.</p>
NF-4	<p>Spring Rolls</p> <p>Ingredients: 100g Chicken breast (skinless) 100g Carrot</p> <p>Seasonings: (A) 1 1/2 tbsp. Oyster sauce 1 tbsp. Soy sauce 2/3 tsp. Sesame oil 1 tbsp. Potato starch Few Salt, Pepper</p>	<p>8-12°C</p> <p>25g Chinese chive 8 piece Skin of spring rolls</p> <p>Few Soft wheat flour with water Few Oil</p>	<p>2-4 serves (4-8 pieces)</p>	<p>1. Cut chicken breast and carrot into smaller slices. Cut Chinese chive into chunks</p> <p>2. Marinate (1) with blended seasonings (A). Divide it into 8equal pieces</p> <p>3. Mix soft wheat flour with water</p> <p>4. Wrap (2) around skin of spring rolls. Stick it with (3)</p> <p>5. Brush (4) with oil to avoid sticking. Place on turntable</p> <p>6. When oven has stopped, turn over and continue to cook.</p>

HOMEMADE FRESH PIZZA RECIPE

[Ingredients] (1 portion)

- Dough**
- Flour..... 150 g
 - Water (lukewarm)..... 90 ml
 - Yeast..... 7 g
 - Sugar..... 1 tsp.
 - Salt 1/2 tsp.
 - Olive Oil 2 tsp.
- Toppings**
- Canned Tomatoes..... 50 g
 - Tomato Paste 50 g
 - * Topping Varieties..... 180 g
(Corn, Pineapple, Ham, Salami)
 - Grated Cheese..... 150 g
 - * Spices Varieties to taste
(Basil, Oregano, Thyme, Salt, Pepper)

[Method]





1. Dough Preparation-
Make a deepening in the flour. Mix the lukewarm water with yeast and let stand for around 5 minutes. Pour the mixture into the deepening, then add sugar, salt & olive oil. Mix carefully to form a dough. Put the dough in a deep bowl and slightly cover with wrap. Then let stand for 30 minutes.
2. Roll out the dough to a round sheet, with diameter 8 inches (or 12 inches). Raise the edge with the thumb to form a rim, then put the sheet of dough onto the turntable brushed with oil.
3. Drain the canned tomatoes and cut into pieces, mix well with tomato paste and the spices varieties. Spread the mixture onto the sheet of dough. Then add grated cheese, followed by the topping varieties. Sprinkle with grated cheese again before baking.
4. The Pizza function enables you to make different types or size of pizza. Adjust the portion of ingredients (dough and toppings) as follows and enter the weight of pizza to start baking:-

Type	Thin Crust		Thick Crust	
Size	8 inches	12 inches	8 inches	12 inches
Portion of Dough	1 portion (As above)	1 1/2 portions	1 1/2 portions	2 1/2 portions
Portion of Toppings	1 portion (As above)	2 portions	1 portion (As above)	2 portions

*Topping and spices varieties can be adjusted according to personal flavour.

5. After cooking, stand.

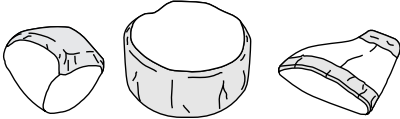
Easy Defrost Menu Guide

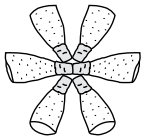
MENU	QUANTITY	PROCEDURE
Steaks Chops 	0.1 - 2.0 kg	<ul style="list-style-type: none"> Shield thin end of chops or steaks with foil. Position the food with thinner parts in the centre in a single layer on a shallow dish. If pieces are stuck together, try to separate as soon as possible. When oven has stopped, remove defrosted pieces, turn over and shield the defrosted portions. Press start to continue defrosting. After defrost time, stand covered with aluminium foil for 5-30 minutes.
Minced Meat Beef/Pork 	0.1 - 2.0 kg	<ul style="list-style-type: none"> Place frozen minced meat on a shallow dish. Shield edges. When oven has stopped, remove defrosted portions, turn over and shield edges with foil strips. Press start to continue defrosting. After defrost time, stand covered with aluminium foil for 5-30 minutes. <p>NOTE When defrosting small amount, it is recommended to check occasionally during defrosting to avoid overdefrosting.</p>
Roast Meat Beef/Pork/Lamb 	0.5 - 2.0 kg	<ul style="list-style-type: none"> Shield the edge with foil strips about 2.5cm wide. Place joint with lean side face upwards (if possible) on a shallow dish. When oven has stopped, turn over and shield the defrosted portions. Press start to continue defrosting. After defrost time, stand covered with aluminium foil for 10-30 minutes.
Poultry 	1.0 - 2.0 kg	<ul style="list-style-type: none"> Remove from original wrap. Place breast side down on a shallow dish. When oven has stopped, turn over and shield the defrosted portions such as wing and leg tips with foil. Press start to continue defrosting. After defrost time, stand covered with aluminium foil for 15-60 minutes. <p>NOTE After standing run under cold water to remove giblets if necessary.</p>
Chicken Pieces 	0.1 - 2.0 kg	<ul style="list-style-type: none"> Shield the exposed bone with foil. Place chicken pieces on a shallow dish. When oven has stopped, remove defrosted pieces, turn over, rearrange and shield the defrosted portions. Press start to continue defrosting. After defrost time, stand covered with aluminium foil for 5-30 minutes.

Food not listed in the Guide can be defrosted manually using 30% (MED LOW) power level.

- NOTE**
- When freezing minced meat, shape it into flat even sizes.
 - For chicken pieces, steaks and chops, freeze separately in single flat layers and if necessary interleave with freezer plastic to separate layers. This will ensure even defrosting.
 - It is also a good idea to label the packs with the correct weights.

SHARP
SHARP CORPORATION

TINS-A870WRRZ-V61