

SHARP®

KC-G60E

KC-G50E

KC-G40E

KC-G60L

KC-G50L

KC-G40L

KC-G60M

KC-G40M

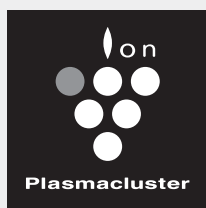

High-Density 7000 *

Device of this mark is a trademark of Sharp Corporation.

“Plasmacluster” and “Device of a cluster of grapes” are registered trademarks of Sharp Corporation in Japan, Philippines and elsewhere.



Free standing type
Jenis berdiri sendiri
直立式

AIR PURIFIER
with Humidifying Function
OPERATION MANUAL

PEMBERSIH UDARA
dengan Fungsi Melembap
BUKU PANDUAN OPERASI

加湿空气净化器
使用说明书

ENGLISH

B. MELAYU

中文

* The number in this technology mark indicates an approximate number of ions supplied into air of 1 cm³, which is measured around the center of a room with the “high-density plasmacluster 7000” applicable floor area (at 1.2 m height above the floor) when the product is placed close to a wall at the MED mode setting.

FEATURES

**A unique Combination of Air Treatment Technologies
Triple Filtration System + Plasmacluster + Humidification**

TRAPS DUST
Pre-filter traps dust larger than approx 240 micron particles.

DECREASES ODORS
Deodorizing filter absorbs harmful gases in HAZE*1 and many common household odors.

REDUCES TINY DUST, POLLEN & MOLD*2
HEPA filter traps 99.97% of particles as small as 0.3 microns.

FRESHENS
By emitting a balance of positive and negative ions, Plasmacluster air treatment is a natural process.

HUMIDIFIES
Controls humidity by sensing temperature and humidity automatically.

*1: Toluene etc. The deodorizing performance for a single component odors substance in a 1m³ test container may be different than the deodorizing performance in actual use.

*2: When air is circulated through the filter system.

Sensor Technology continuously monitors air quality and room condition, and automatically adjusts operation.

INTELLIGENT MODE

(KC-G60 / KC-G50)

6 sensors sensing 7 factors precisely control automatic operation.



7 detection by 6 sensors

SENSOR	DETECTION
Dust (sensitive)	PM2.5 (particulate matter less than 2.5 microns), etc.
	Tobacco smoke, house dust (dirt, mite feces and remains, mold spores, pollen)
Odor	Tobacco, cosmetic, alcohol, spray, and other odors
Temperature	Room temperature
Humidity	Room humidity
Light	Room brightness
Motion*3	Movement of persons or pets

*3: Senses only when Intelligent mode is in operation.

When a person or pet is in the sensory area*4
(*4: Ref.E-5)

- When there is little movement of a person or pet (example: when sleeping), automatically switches to quiet air flow.
- When the room is dark, the Front Display, Cleanliness Monitor and Air Outlet LED turn off automatically.

When there is no movement in the sensory area

- The Front Display, Cleanliness Monitor and Air Outlet LED turn off, humidifying stops, and the unit switches to minimum airflow to save power consumption.
- When room humidity is over 80% and the room is bright, Plasmacluster Ions are emitted with strong airflow.

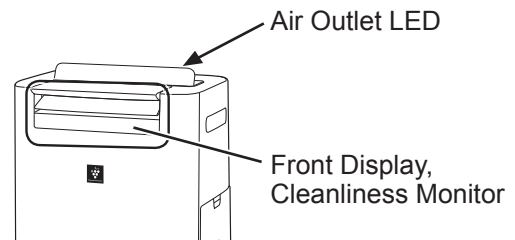

NOTE

- When in Intelligent mode you can manually switch humidifying ON or OFF (Ref.E-8)
- Front Display and Air Outlet LED automatically switch ON and OFF based on room brightness. (When light control is set to "Auto". Ref.E-10)
- When the Motion Sensor senses that no one has been in the room for a set interval of time it determines that the room is unoccupied.
- You can change brightness of Display / Monitor, sensor sensitivity, and Motion Sensor sensing time. (Ref.E-10)
- Motion sensor may sense movement other than persons or pets. (waving curtain etc.)

Please read before operating your new Air Purifier

The air purifier draws in room air through the air intake, circulates it through a Pre-Filter, a Deodorizing Filter and a HEPA Filter inside the unit, and then discharges it through the air outlet. The HEPA Filter can remove 99.97% of dust particles as small as 0.3 microns that pass through the filter and also helps absorb odors. The Deodorizing Filter gradually absorbs odors as they pass through the filter.

Some odors absorbed by the filters will break down over time, causing additional odors. Depending on usage conditions, and especially if the unit is used in environments significantly more severe than a normal household, these odors may become noticeable sooner than expected. If these odors persist, replace the filters. (Ref. E-13)

When minerals in tap water adhere to the filters and become a hard and white, they absorb odors in the room that can cause the emission of an unpleasant odor when the humidifying filter is dry. (Varies depending on water quality and other environmental factors) If this occurs, perform humidifying filter maintenance. (Ref.E-12)

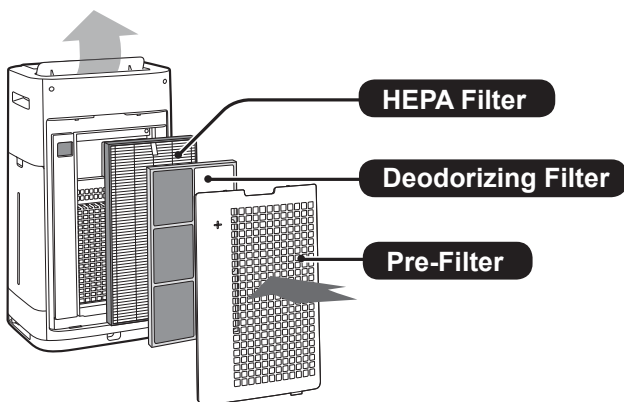

NOTE

- The air purifier is designed to remove air-suspended dust and the odors. The air purifier is not designed to remove harmful gases such as carbon monoxide contained in cigarette smoke. The air purifier may not completely remove an odor if the source of the odor is still present.

CONTENTS

IMPORTANT SAFETY INSTRUCTIONS ...	E-3
• WARNING	
• NOTE	
• CAUTIONS CONCERNING OPERATION	
• INSTALLATION GUIDELINES	
• FILTER GUIDELINES	
PART NAMES	E-5
• FRONT	
• BACK	
• OPERATION PANEL	
• FRONT DISPLAY	
PREPARATION	E-7
• FILTER INSTALLATION	
OPERATION	E-7
• START / STOP	
• HAZE MODE	
• INTELLIGENT MODE (KC-G60 / KC-G50)	
• AUTO MODE (KC-G40)	
• PLASMACLUSTER ION SPOT MODE	
• SELECTING MODE	
• CHILD LOCK	
• HUMIDIFICATION SETTING (REFILLING THE WATER TANK)	
• ON TIMER	
• OFF TIMER	
• SELECTING DISPLAY	
• PLASMACLUSTER ION ON / OFF	
• HOW TO CHARGE VARIOUS SETTINGS	
CARE AND MAINTENANCE	E-11
• FILTER INDICATOR	
• CARE INDEX	
• WATER TANK	
• UNIT / BACK PANEL	
• HUMIDIFYING FILTER AND TRAY	
• HEPA FILTER / DEODORIZING FILTER	
• FILTER REPLACEMENT	
TROUBLESHOOTING	E-14
SPECIFICATIONS	E-15

Thank you for purchasing this SHARP Air Purifier. Please read this manual carefully before using the air purifier. After reading, keep the manual in a convenient location for future reference.

IMPORTANT SAFETY INSTRUCTIONS

Always follow basic safety precautions when using electrical appliances, including the following:

WARNING – Always observe the following to reduce the risk of electrical shock, fire, or injury:

- Read all instructions before using the unit.
- Use only a 220-240 volt outlet.
- **This appliance is not intended for use by persons (including children) with reduced physical, sensory or mental capabilities, or lack of experience and knowledge, unless they have been given supervision or instruction concerning use of the appliance by a person responsible for their safety. Children should be supervised to ensure they do not play with the appliance.**
- **If the power cord is damaged, it must be replaced by the manufacturer, its service agent, a Sharp authorized Service Center or similarly qualified persons in order to avoid a hazard.**
- **Be sure to remove the power plug when refilling the Water Tank, before performing maintenance, when removing and attaching and replacing the filter and when not using for a long time. Failure to do so can cause a short circuit resulting in electrical shock or fire.**
- Do not use the unit if the power cord or plug is damaged or if the connection to the wall outlet is loose.
- Periodically remove dust from the plug.
- Do not insert fingers or foreign objects into the air intake or air outlet.
- When removing the power plug, always hold the plug and never pull on the cord. Failure to do so can cause a short circuit resulting in electrical shock or fire.
- When removing the unit, do not damage the power cord with the casters. Failure to do so can cause electric shock, heat generation, or fire.
- Be careful not to damage the power cord, it may cause electric shock, excess heat or fires.
- Do not remove the plug when your hands are wet.
- Do not place the unit near gas appliances or fireplaces.

- Only a Sharp Authorized Service Center should service this air purifier. Contact the nearest Service Center for any problems, adjustments, or repairs.
- Do not operate the unit in rooms where aerosol insecticides are present. Do not operate the unit in rooms where there is oily residue, incense, sparks from lit cigarettes, or chemical fumes in the air. Do not operate the unit in places where it may get wet, such as a bathroom.
- Be cautious when cleaning the unit. Strong corrosive cleansers can damage the exterior.
- When carrying the unit, first remove the Water Tank and Humidifying Tray, and then hold the unit by the handles on both sides.
- Do not drink the water in the Humidifying Tray or Water Tank.
- Do not expose the unit to water. Doing so can cause a short circuit or electrical shock.
- Replace the water in the Water Tank daily with fresh tap water, and regularly clean the Water Tank and Humidifying Tray (see E-8, E-11 and E-12). When the unit is not in use, dispose of the water in the Water Tank and Humidifying Tray. Leaving water in the Water Tank or Humidifying Tray can cause mold, bacteria, and bad odors. In rare cases, such bacteria can be a health hazard.

NOTE – What to do if the unit interferes with radio or TV reception

If the air purifier interferes with radio or television reception, try one or more of the following measures:

- Adjust or reposition the receiving antenna.
- Increase the distance between the unit and the radio or TV.
- Connect the equipment into an outlet on a circuit different from that of the radio or TV receiver.
- Consult the dealer or a qualified radio or TV technician.

CAUTIONS CONCERNING OPERATION

- Do not block the air intake or air outlet.
- Do not place the unit near or on hot objects, such as stoves or heaters, or where it may come into contact with steam.

- Always operate the unit in an upright position.
- When moving the unit, use the handles on both sides.
Do not move the unit when it is in operation.
- If the unit is on easily damaged flooring, an uneven surface, or thick-piled carpet, lift it up when moving.
- When moving the unit by its casters, move it slowly and in a horizontal direction.
- Turn the unit off and remove the water tank before moving, take care not to catch your fingers.
- Do not operate the unit without the filters, the Water Tank, and the Humidifying Tray properly installed.
- Do not wash and reuse the HEPA filter and the Deodorizing filter.
Doing so will not improve filter performance and can also cause electric shock or operating malfunctions.
- Clean the exterior with a soft cloth only. Do not use volatile fluids or detergents. The unit surface may be damaged or cracked with Benzene paint thinner or polishing powder. In addition, the sensors may malfunction as a result.
- The frequency of descaling maintenance will depend on the hardness of and the impurities in the water that you use; the harder the water the more often descaling will be necessary.
- Keep the unit away from water.
- When refilling the Water Tank, make sure of no water leaking from the Water Tank.
- Be sure to wipe off any excess water on the outside of the Water Tank.
- Do not use hot water (40 °C or more), chemical agents, aromatic substances, dirty water, or other damaging substances. Doing so can deform the unit or cause it to malfunction.
- Use only fresh tap water. Using other water sources risks the growth of molds, fungi, or bacteria.
- Do not shake the Water Tank with holding the carrying handle.
- Do not remove the Humidifying Filter from the filter frame except replacing it.
- Avoid spilling water when removing or cleaning the Humidifying Tray.
- Do not remove the Float.
If it comes off, refer to E-13.

- Do not use the detergents for maintenance of the Humidifying Tray and Cover. If cause deformation, tarnishing, cracking (water leakage).
- Do not scrub the Back Panel hard during its maintenance.

INSTALLATION GUIDELINES

- Avoid locations where the sensors are exposed to direct wind.
Doing so can cause the unit to malfunction.
- Avoid locations where furniture, fabrics, or other objects can come in contact with the unit and interfere with the intake and outtake of air.
- Avoid locations where the unit is exposed to condensation or drastic changes in temperature. Appropriate room temperature is between 0 – 35 °C.
- Place the unit on a level and stable surface with sufficient air circulation.
When placed on heavy carpet, the unit may vibrate slightly.
Place the unit on a level surface to avoid water leakage from the Water Tank and Humidifying Tray.
- Avoid locations that generate grease or oily smoke.
Doing so can cause the unit exterior to crack and the sensors to malfunction.
- The dust collecting ability of the unit is effective even when the unit is as close to 3 cm from the wall, the surrounding walls and floor may get dirty. Please place the unit at a distance from the wall.
The wall directly behind the air outlet may become dirty over time. When using the unit for an extended period of time at the same location, periodically clean the walls adjacent to it.

FILTER GUIDELINES

- Follow the instructions in this manual for proper filter care and maintenance.
(Ref.E-11, E-12, E-13)

PART NAMES

FRONT

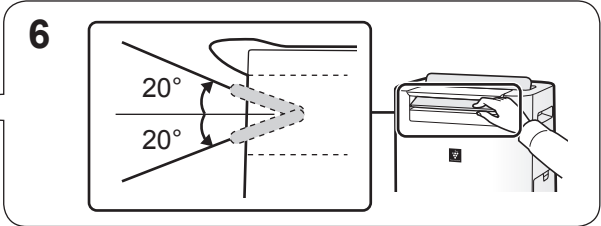
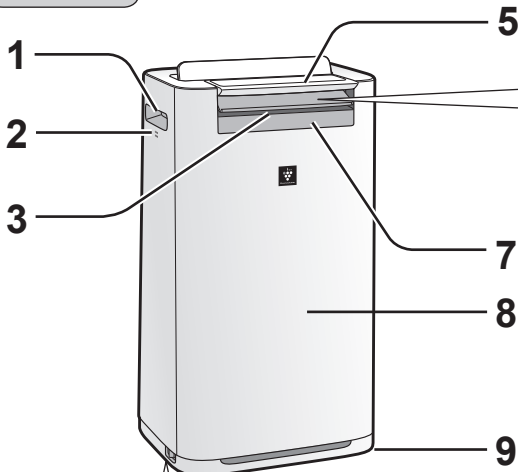

1	Handle (2 Locations)
2	Sensor (Internal) Temperature / Humidity / Odor* (*KC-G60 / KC-G50)
3	Air Outlet (Front)
4	Caster Stopper (Right & Left)
5	Operation Panel
6	Front Louver (Adjustable)
7	Front Display
8	Unit
9	Caster (4 Locations)

4 To Lock a caster stopper (Right & Left)

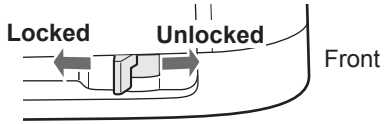

BACK

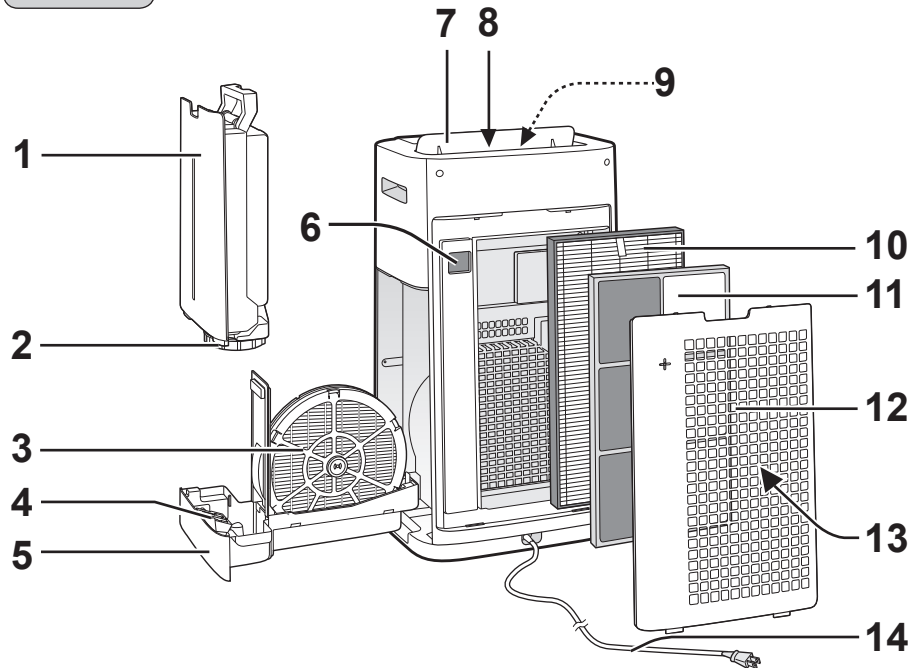

(Plug shape varies by country.)

1	Water Tank	7	Back Louver
2	Tank Cap	8	Air Outlet (Back)
3	Humidifying Filter	9	Air Outlet LED(White)
4	Float	10	HEPA Filter
5	Humidifying Tray	11	Deodorizing Filter
6	Dust(sensitive) Sensor / Sensor Filter	12	Back Panel (Pre-Filter)
		13	Air Inlet
		14	Power Cord / Plug

Detection range

Light Sensor

Do not install the unit in the following places.
The Light Sensor may not sense correctly.

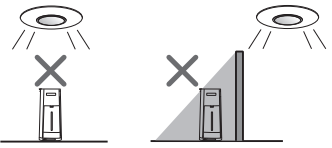

Directly under a light fixture.

In shadow

Motion Sensor (KC-G60 / KC-G50)

Sensory range is the area shown below.

Front

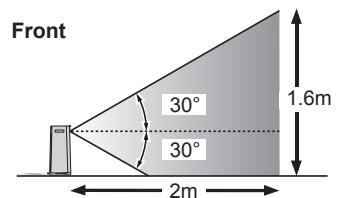

Right and Left

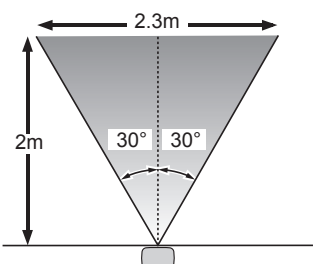

OPERATION PANEL

Press the button with "★" to start.

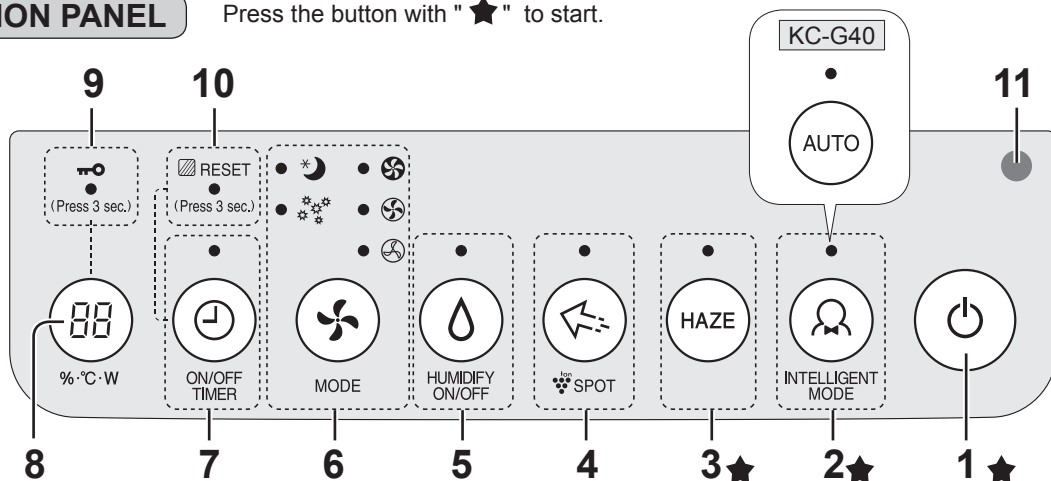

1	POWER ON / OFF Button	7	ON / OFF TIMER Button, Indicator Light (White) <Press 3 sec.> FILTER RESET Button
2	INTELLIGENT MODE Button, Indicator Light (White)	8	DISPLAY SELECT Button <Press 3 sec.> CHILD-LOCK Button
3	HAZE Button, Indicator Light (White)	9	CHILD-LOCK Indicator Light (White)
4	Plasmacluster Ion SPOT Button, Indicator Light (White)	10	FILTER RESET Indicator Light (Orange)
5	HUMIDIFY ON / OFF Button, Indicator Light (White)	11	Light Sensor
6	MODE Button, Indicator Light (White)		

FRONT DISPLAY

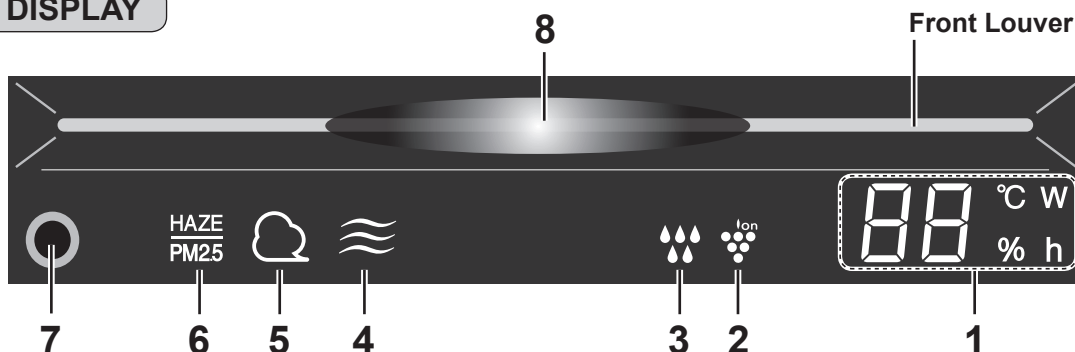

1	Humidity / Temperature Monitor Indicates the approximate humidity level or temperature in the room. The humidity setting cannot be adjusted. Humidity 20% to 90% is displayed. 20% or less 20% ← 55% → 90% or more Temperature 0°C to 50°C is displayed. -1°C or less Lo °C ← 25 °C → H °C or more	4	Odor Light (White) (KC-G60 / KC-G50) Indicates the Odor Sensor detects odors.
	Wattage Monitor Indicates wattage by current operation. Timer Monitor Indicates setting time or remaining time of ON/OFF timer.		5
2	Plasmacluster Ion Light (Blue)	6	HAZE / PM2.5 Light (White) Indicates the Dust(sensitive) Sensor detects microscopic dust.
3	Humidify Light Green Humidity ON Off Humidity OFF Red(Flashing) Unit needs water	7	Motion Sensor (KC-G60 / KC-G50)
		8	Cleanliness Monitor Indicates the air purity of the room in 7 levels with color changes. Blue Clean ↕ Red Impure

PREPARATION

Always be sure to remove the power plug from the wall outlet.



FILTER INSTALLATION

1 Remove the Back Panel.

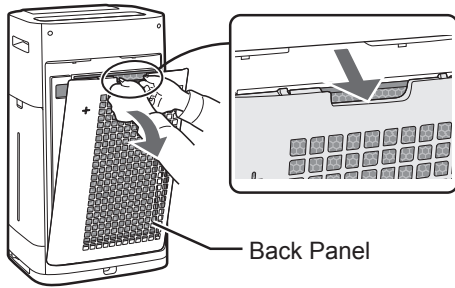

2 Remove the plastic bag from the each filter.

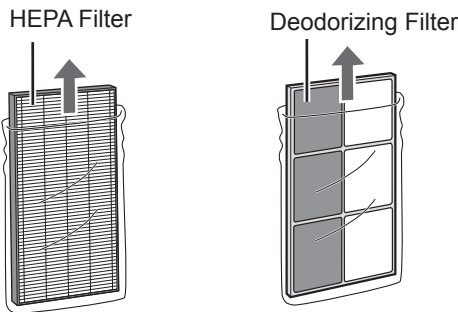

3 Install the filters in the correct order as shown.

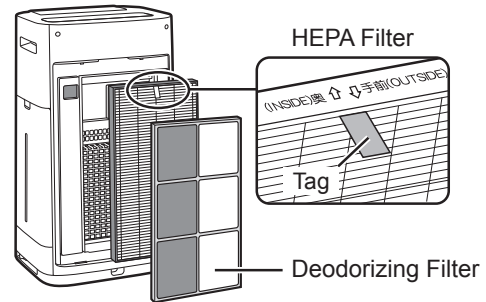

4 Install the Back Panel.

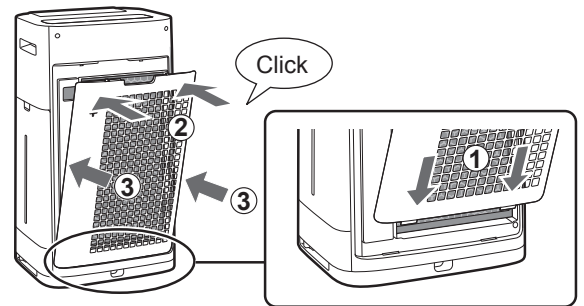

NOTE

- When replacing the filter, making a memo of the start of use date is recommended.

OPERATION

START/STOP

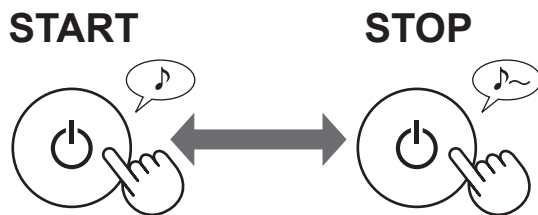

HAZE MODE

Operates at HIGH fan speed for 60 minutes and then alternates between Low and High level for 20 minutes each.

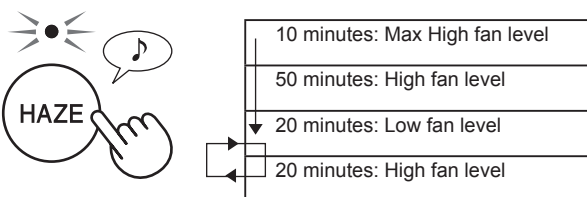

NOTE

- The Plasmacluster Ion can not be turned "OFF". (Ref.E-9)

INTELLIGENT MODE (KC-G60 / KC-G50)

The fan speed is automatically controlled depending on the 7 detection. (Ref.E-1)

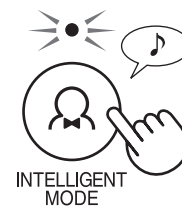

AUTO MODE (KC-G40)

The fan speed is automatically controlled depending on the 5 detection. (PM2.5 / Usual dust / Temperature / Humidity / Light)

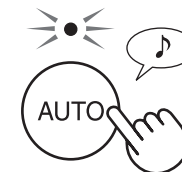

NOTE

- Front Display, Cleanliness Monitor and Air Outlet LED automatically switch ON and OFF based on room brightness. (When light control is set to "Auto". Ref.E-10)

ON TIMER

Select the length of time you want. The unit automatically starts once the selected time is passes.

(with the unit OFF)

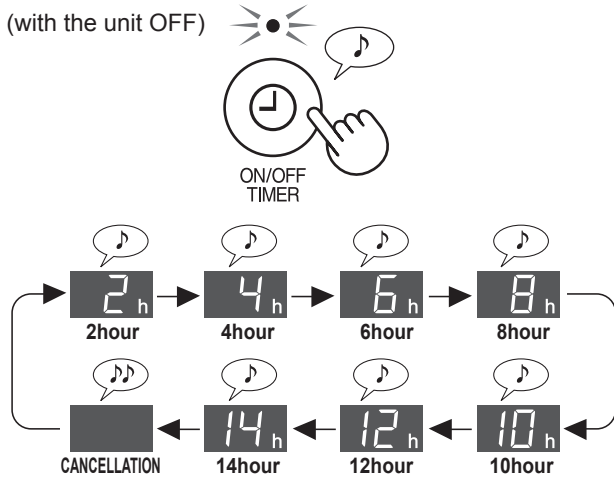

OFF TIMER

Select the length of time you want. The unit automatically stops once the selected time is reached.

(with the unit ON)

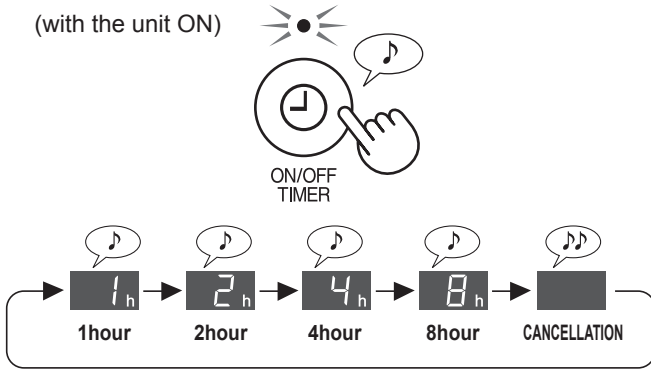

SELECTING DISPLAY

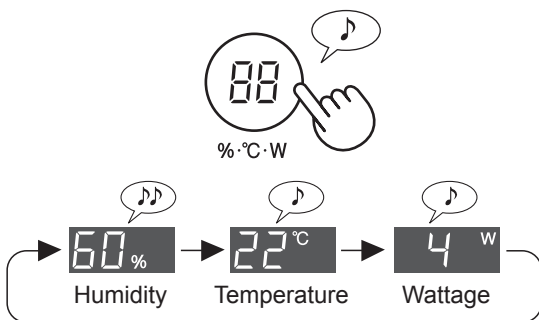

PLASMACLUSTER ION ON/OFF

When the Plasmacluster function is ON, the Plasmacluster Ion light on the Front Display is on. (Ref.E-6)

(with the unit ON)

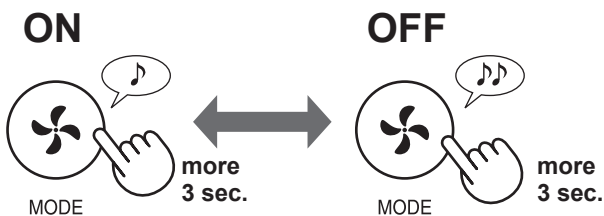

HOW TO CHANGE VARIOUS

You can change the functions in the "Type of setting" table on the next page.

1 Turn the unit power OFF.



3 Select "Function number" from the table on next page.

Forward

Reverse

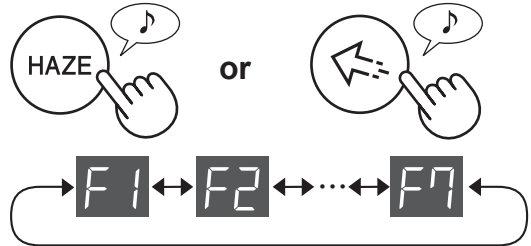

Set

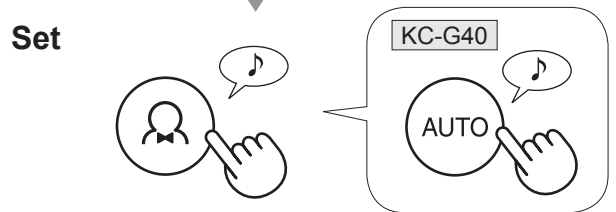

4 Select "Setting number" from the table on next page.

Forward

Reverse

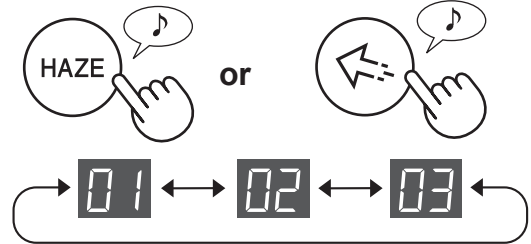

Set

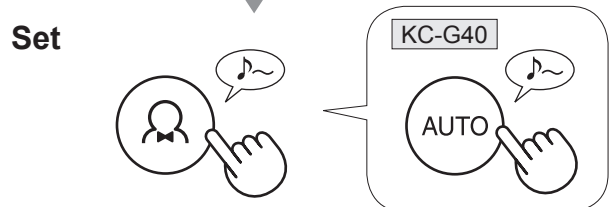

5 Press Power button to finish the setting.



SETTINGS

Type of setting

Function	Setting
<p>Light Control</p> <p>You can select the brightness of the Front Display, Cleanliness Monitor and Air Outlet LED.</p> <p style="text-align: right;">F1</p>	<p>01 Auto (default) Light automatically switches ON or OFF based on room brightness. Room is bright: light is ON Room is dark: light is OFF</p> <p>02 Darker</p> <p>03 Turn off</p> <ul style="list-style-type: none"> When set to "Turn off", the "Darker" light illuminates for 3 seconds after operation starts and then the light turns off. The Humidity Light flashes darker only when the unit needs water.
<p>Sound Indicator Setting</p> <p>You can set the unit to make a beeping sound when the Water Tank is empty.</p> <p style="text-align: right;">F2</p>	<p>01 Cancellation (default)</p> <p>02 ON</p>
<p>Auto Restart</p> <p>If the unit is unplugged or if there is a power failure, the unit will resume operation with the previous settings after power is restored.</p> <p style="text-align: right;">F3</p>	<p>01 Cancellation</p> <p>02 ON (default)</p>
<p>Adjusting Sensor Sensitivity (F4-F7)</p>	
<p>Light Sensor</p> <p style="text-align: right;">F4</p>	<p>01 Low</p>
<p>Dust(sensitive) Sensor</p> <p style="text-align: right;">F5</p>	<p>02 Standard (default)</p>
<p>Odor Sensor (KC-G60 / KC-G50)</p> <p style="text-align: right;">F6</p>	<p>03 High</p>
<p>Motion Sensor (KC-G60 / KC-G50)</p> <p>You can set the time until the Motion Sensor detects that no one is in the room . You can also cancel Motion Sensor sensing.</p> <p style="text-align: right;">F7</p>	<p>01 ON(Standard sensing time) (default)</p> <p>02 ON(Longer sensing time)</p> <p>03 Cancellation</p>

CARE AND MAINTENANCE



FILTER INDICATOR

The filter reset Indicator light will turn on after approximately 720 hours operating. (30 days × 24 hours = 720 hours)

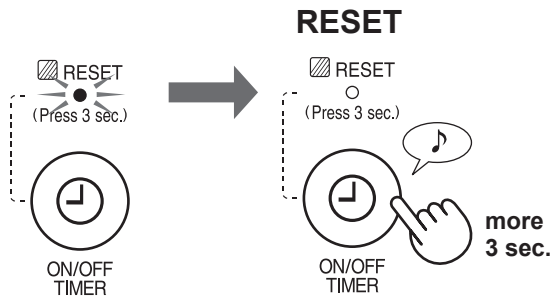

This is a reminder to perform the maintenance described below. After performing maintenance, reset the Filter Indicator.

CARE INDEX

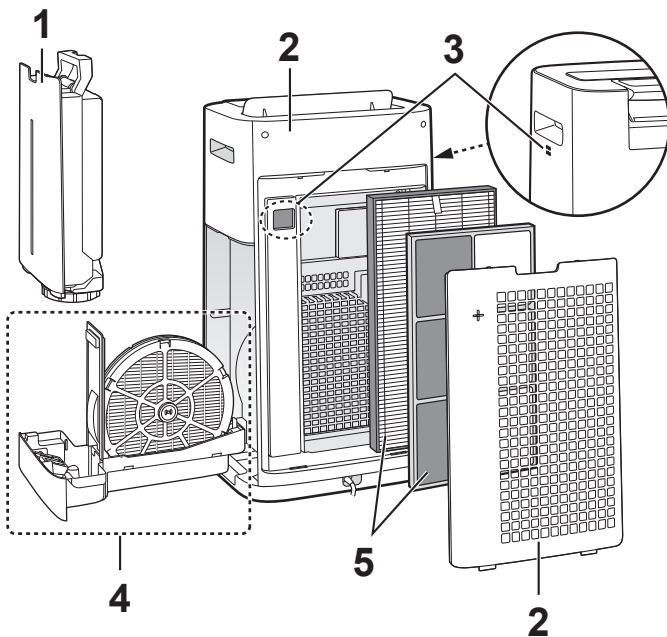

	Place	Ref.
1	Water Tank	E-11
2	Unit / Back Panel (Pre Filter)	
3	Sensors	
4	Humidifying Filter Humidifying Tray	E-12
5	HEPA Filter Deodorizing Filter	E-13

WATER TANK

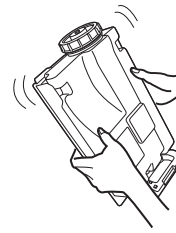

Rinse the inside with a water.

NOTE How to clean hard to remove dirt.

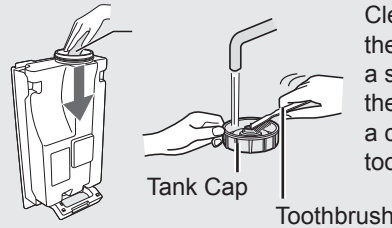

Clean the inside of the Water Tank with a soft sponge and the Tank Cap with a cotton swab or toothbrush.

UNIT / BACK PANEL

Wipe with a dry, soft cloth.

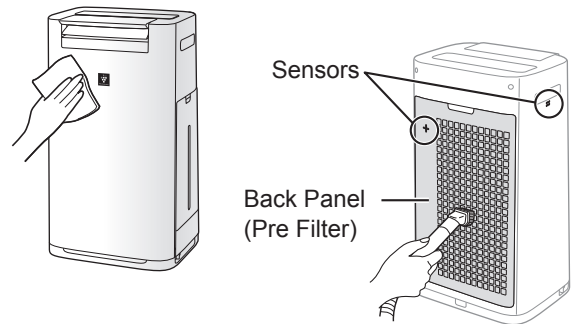

Remove the dust gently with a cleaning tool such as a vacuum cleaner.

NOTE How to clean hard to remove dirt.

Back Panel

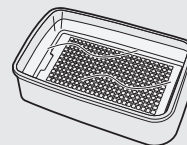

1. Add a small amount of kitchen detergent to water and soak for about 10 minutes.

CAUTION

Do not apply excessive pressure when scrubbing the back panel.

2. Rinse off the kitchen detergent with clean water.
3. Completely dry the filter in a wellventilated area.

Sensor Filter



Sensor Filter

1. Remove the Back Panel.
2. Remove the sensor filter.
3. If the sensor filter is very dirty, wash it with water and dry it thoroughly.

HUMIDIFYING FILTER AND TRAY

HOW TO REMOVE THE HUMIDIFYING FILTER AND TRAY.

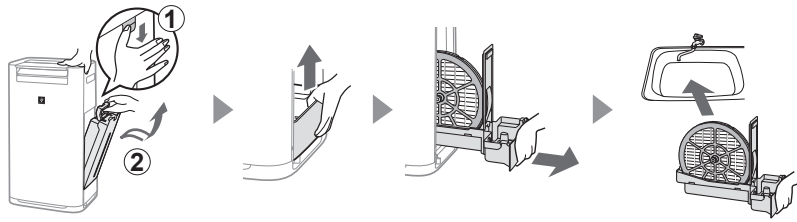

HOW TO ATTACH THE HUMIDIFYING FILTER AND TRAY.

After maintenance, correctly reattach the parts.

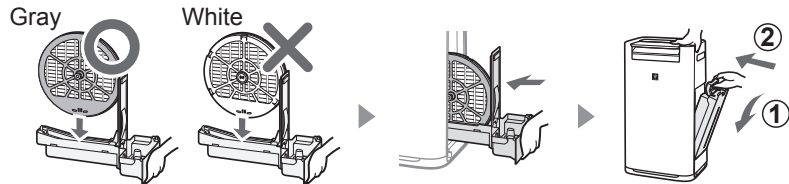

Humidifying Filter

Rinse with plenty of water.

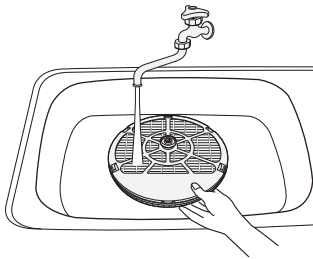

NOTE

If you remove the Humidifying Filter shaft, be sure to reattach it to its original position.

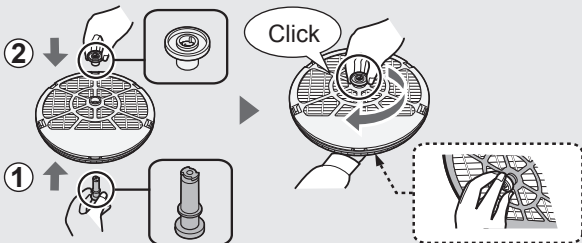

Humidifying Tray

1 Remove the Humidifying Tray Cover.

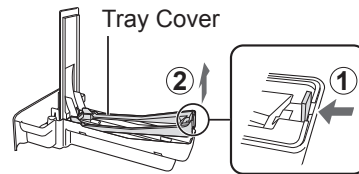

2 Rinse with plenty of water.

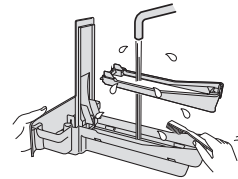

3 Reattach the Humidifying Tray Cover.

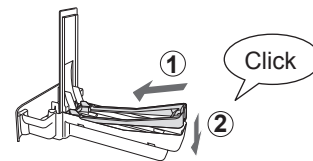

•Do not remove the Float and the Tray Panel. If they come off, refer to E-13.

NOTE How to clean hard to remove dirt.

	Kitchen detergent (only Humidifying tray)	Citric acid (available at some drugstores)	100% bottled lemon juice with no pulp
1	1. Fill the tray half-way with water. 2. Add a small amount of kitchen detergent.	2 1/2 cups of water 3 teaspoons	3 cups of water 1/4 cup
2	Soak for 30 minutes.	Soak for 30 minutes.	Soak for 30 minutes. (When using lemon juice as your descaling solution, allow for more soak time.)
3	Rinse off the kitchen detergent or the descaling solution with clean water.		

HEPA FILTER / DEODORIZING FILTER

Remove the dust on the HEPA Filter and Deodorizing Filter.

CAUTION

- Do not wash the filters. Do not expose to sunlight.

HEPA FILTER

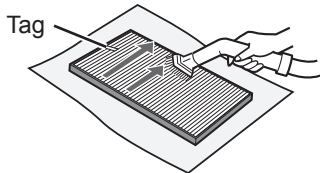

Maintain only the tagged surface. Do not clean up the opposite surface. The filter is fragile, so be careful not to apply too much pressure.

DEODORIZING FILTER

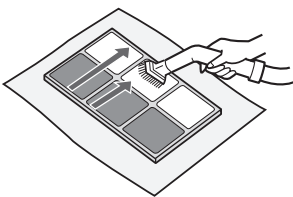

Both surfaces can be maintained. The filter may be broken if being too much power is applied on it, so please handle it with care.

Some odors absorbed by the filters will break down over time, causing additional odors. Depending on usage conditions, and especially if the unit is used in environments significantly more severe than a normal household, these odors may become noticeable sooner than expected.

Replace the filter in those cases or if dust is unable to be removed after maintenance.

How to install the Float and the Tray Panel

Tray Panel

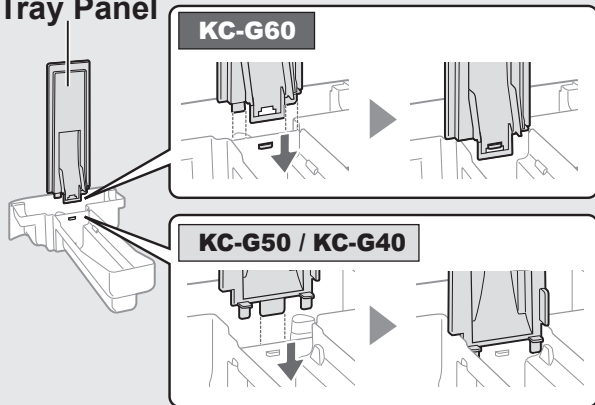

Float

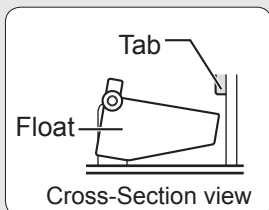

1. Insert the float under this tab.

3. Insert the tab on the other side of the float into the hole.

2. Insert the tab of the float into the hole.

FILTER REPLACEMENT

LIFE OF FILTERS

Filter life varies depending on the room environment, usage conditions, and location of the unit. Lifespan of HEPA filter and Deodorizing filter and replacement suggestions are based on purifying a room in which 5 cigarettes are smoked per day and the unit's dust collection and deodorizing performance has declined to half the level of a new filter.

We recommend replacing the filter more frequently if the unit is used in conditions significantly more severe (HAZE etc.) than a normal household.

- HEPA Filter About 10 years after first use
- Deodorizing Filter About 10 years after first use
- Humidifying Filter About 10 years after first use

Replacement Filter Model

Consult your dealer when purchasing a replacement filter.

Replacement Filter	KC-G60	KC-G50	KC-G40
HEPA Filter (1 unit)	FZ-D60HFE	FZ-D40HFE	FZ-D40HFE
Deodorizing Filter(1 unit)	FZ-G60DFE	FZ-G40DFE	FZ-G40DFE
Humidifying Filter(1 unit)	FZ-G60MFE	FZ-G60MFE	FZ-G60MFE

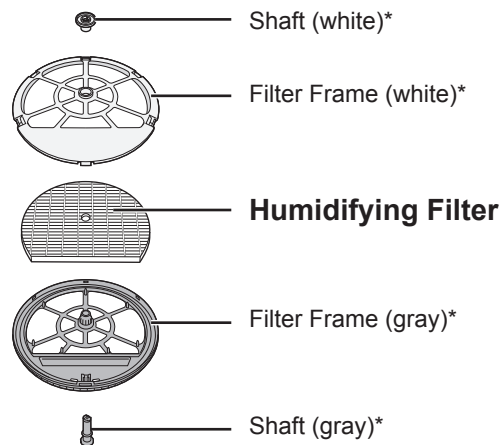

*Do not dispose these parts.

Disposing of filters

Dispose of used filters according to local laws and regulations.

HEPA Filter material:

- Filter: Polypropylene
- Frame: Polyester

Deodorizing Filter material:

- Filter: Paper
- Frame: ABS resin

Humidifying Filter material:

- Filter: Rayon, polyester

TROUBLESHOOTING

Before contact for service, review the troubleshooting chart below to make sure that the problem is not a unit malfunction.

SYMPTOM	REMEDY (the following are not due to a malfunction)
Odor and smoke persists.	<ul style="list-style-type: none"> Check the filters. If they appear to be extremely dirty, clean or replace them. (Ref. E-13)
The Cleanliness Monitor is blue even when the air is not clean.	<ul style="list-style-type: none"> The air may have been dirty when the unit was plugged in. Unplug the unit, wait one minute, and then plug the unit in again.
The Cleanliness Monitor light is red even when the air is clean.	<ul style="list-style-type: none"> Dirty or clogged dust(sensitive) sensor openings interfere with sensor operation. Gently clean the sensor filter or the back panel. (Ref. E-11).
The unit makes a clicking or ticking sound.	<ul style="list-style-type: none"> The unit may make clicking or ticking sounds when it is generating ions.
Air discharged from the unit has an odor.	<ul style="list-style-type: none"> Check to see if the filters are extremely dirty. Clean or replace the filters. (Ref. E-11, E-12, E-13) Use only fresh tap water. Using other water sources risks the growth of molds, fungi, or bacteria.
The unit does not operate when cigarette smoke is in the air.	<ul style="list-style-type: none"> Make sure the unit is installed in a location in which the sensors can detect cigarette smoke. Check to see if the dust(sensitive) sensor openings are blocked or clogged. If they are blocked or clogged, clean the sensor filter or the back panel. (Ref. E-11)
The FILTER RESET Indicator Light is on.	<ul style="list-style-type: none"> Whenever after performing maintenance or replacing the filters, connect the power cord to an outlet and then press the Filter Reset Button. (Ref. E-11)
The Front Display is turned off.	<ul style="list-style-type: none"> When Light control is set to "Auto", the light automatically turns off when the room is dark. Moreover, when Light control is set to "Turn off", the light is always off. If you do not want the light to be off, set Light control to the "Darker" setting. (Ref. E-9, E-10)
The Humidify Light on the Front Display does not light up when the tank is empty.	<ul style="list-style-type: none"> The room has reached the appropriate level of humidity and has stopped humidifying. Check the styrofoam float for impurities. Clean the Humidifying Tray. Make sure that the unit is on a level surface. (Ref. E-12)
The water level in the tank does not decrease or decreases slowly.	<ul style="list-style-type: none"> Check to see if the Humidifying Tray and Water Tank are correctly installed. Check the Humidifying Filter. (Ref. E-12) If the filter is extremely dirty, clean or replace it. (Ref. E-13)
The Cleanliness Monitor changes color frequently.	<ul style="list-style-type: none"> The Cleanliness Monitor automatically changes color when the dust(sensitive) sensor and odor sensor* detect impurities. If you are concerned about the change, you can change sensor sensitivity. (Ref. E-9,E-10) (*KC-G60 / KC-G50)
There is a discrepancy between the unit's Humidity Monitor and another hygrometer in the room.	<ul style="list-style-type: none"> There is a difference in the humidity level within the same room. The sensor have different measurement parameters. If the monitor indicates wattage or temperature, switch the display by pressing the DISPLAY SELECT button. (Ref. E-9)
The unit HAZE / PM2.5 Light does not match weather report or other local PM2.5 data.	<ul style="list-style-type: none"> Outdoor and indoor as well as the home environment (the volume of traffic nearby, number of stories in home, etc.) may cause a reading different than local PM2.5 data.

ERROR DISPLAY

If error occurs repeatedly, contact the Sharp Service Center.

DIGITAL INDICATION	REMEDY
E2	Make sure that the Humidifying Filter and Humidifying Tray are properly installed, and then turn the power to ON again.
E1 E4 E6 E9	Unplug the unit, wait one minute, and then plug the unit in again.

SPECIFICATIONS

Model		KC-G60			KC-G50			KC-G40		
Power supply		220-240 V 50-60 Hz								
Fan Speed Adjustment		MAX	MED	LOW	MAX	MED	LOW	MAX	MED	LOW
CLEAN AIR	Fan Speed (m ³ /hour)	408	240	72	306	180	60	240	120	60
	Rated Power (W)	82	38	5.0	58	26	5.0	33	12	5.0
	Noise Level (dBA)	55	40	7.0	52	47	19	46	41	19
CLEAN AIR & HUMIDIFY	Fan Speed (m ³ /hour)	342	240	72	240	120	60	210	120	60
	Rated Power (W)	55	40	7.0	32	28	7.0	22	14	7.0
	Noise Level (dBA)	53	48	25	46	40	20	43	40	20
	Humidification (mL/hour) *1	630	470	200	450	300	150	400	300	150
Recommended Room Size (m ²) *2		~50			~38			~29		
High density Plasmacluster ion recommended room size (m ²) *3		~35			~28			~21		
Water Tank Capacity (L)		3.0			2.5			2.5		
Sensors		Dust(sensitive) / Odor / Light / Temperature & Humidity / Motion						Dust(sensitive) / Light / Temperature & Humidity		
Cord Length (m)		2.0								
Dimensions (mm)		370 (W) × 293 (D) × 660 (H)			345 (W) × 262 (D) × 631 (H)			345 (W) × 262 (D) × 631 (H)		
Weight (kg)		10.4			8.9			8.9		

- *1 • The amount of humidification changes in accordance with indoor and outdoor temperature and humidity. The amount of humidification increases as temperatures rises or humidity decreases. The amount of humidification decreases as temperatures decrease or humidity rises.
 • Measurement Conditions: 20 °C, 30 % humidity (JEM1426)
- *2 • The recommended room size is one that can be humidified when the unit's fan is operating at the maximum speed setting.
 • The recommended room size is an area in which a given amount of dust particles can be removed in 30 minutes.
- *3 • Room size in which approximately 7000 ions per cubic centimeter can be measured in the center of the room when the unit is placed next to a wall, is running at MED mode settings, and is at a height of approximately 1.2 meters from the floor.

Standby Power

When the unit's power plug is inserted in a wall outlet it consumes about 0.6 watts of standby power in order to operate electrical circuits.
 To conserve energy, unplug the power cord when the unit is not in use.

MEMO

CIRI-CIRI

Gabungan Unik Teknologi Rawatan Udara Sistem Penapisan Tiga Serangkai + Plasmacluster + Pelembapan

MEMERANGKAP HABUK

Prapenapis memerangkap habuk yang lebih besar daripada zarah-zarah yang beranggaran 240 mikron.

MENGURANGKAN BAU

Penapis Penyahbau menyerap gas-gas berbahaya dalam HAZE*¹ dan kebanyakan bau biasa yang terdapat di rumah.

MENGURANGKAN DEBUNGA & KULAPUK*²

Penapis HEPA memerangkap 99.97% zarah sekecil 0.3 mikron.

MENYEGARKAN

Dengan mengeluarkan ion positif dan negatif yang seimbang, rawatan udara Plasmacluster merupakan proses yang semula jadi.

MELEMBAPKAN

Kawal kelembapan dengan mengesan suhu dan kelembapan secara automatik.

*1: Toluena dll. Prestasi penyahbau untuk bekas ujian bahan bau komponen tunggal dalam 1m³ mungkin berbeza daripada prestasi penyahbau dalam penggunaan sebenar.

*2: Apabila udara diedarkan melalui sistem penapisan.

Teknologi Penderia terus memantau kualiti udara dan keadaan bilik serta melaraskan operasi secara automatik.

MOD INTELLIGENT

(KC-G60 / KC-G50)

6 penderia mengesan 7 faktor yang tepat untuk mengawal operasi automatik.

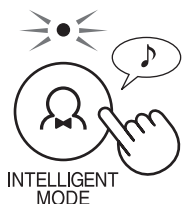

7 pengesanan oleh 6 penderia

PENDERIA	PENGESANAN
Habuk (sensitif)	PM2.5 (zarah lebih kecil daripada 2.5 mikron), dll.
	Asap rokok, habuk di rumah (kotoran, najis dan bangkai tungau, spora kulapuk, debunga)
Bau	Rokok, kosmetik, alkohol, penyembur dan bau lain
Suhu	Suhu bilik
Kelembapan	Kelembapan bilik
Lampu	Kecerahan bilik
Gerakan* ³	Pergerakan individu atau haiwan peliharaan

*3: Mengesan hanya apabila mod Intelligent sedang beroperasi.

Apabila individu atau haiwan peliharaan berada di kawasan yang dipasang penderia*⁴ (*4: Ruj.M-5)

- Apabila terdapat sedikit pergerakan individu atau haiwan peliharaan (contoh: apabila tidur), akan bertukar secara automatik kepada aliran udara senyap.
- Apabila bilik gelap, Paparan Depan, Pemantau Kebersihan dan LED Salur Keluar Udara tertutup secara automatik.

Apabila tiada pergerakan di kawasan yang dipasang penderia

- Paparan Depan, Pemantau Kebersihan dan LED Salur Keluar Udara tertutup, pelembap berhenti dan unit bertukar kepada aliran udara yang minimum untuk menjimatkan penggunaan kuasa.
- Apabila kelembapan bilik melebihi 80% dan bilik cerah, Plasmacluster Ion dikeluarkan dengan aliran udara yang kuat.

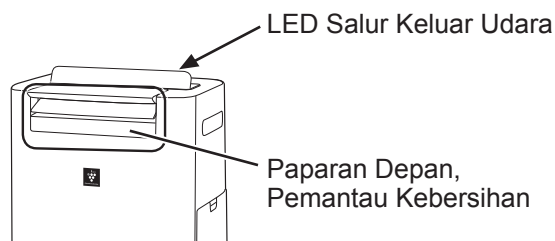

NOTA

- Apabila dalam mod Intelligent anda boleh tukar pelembap kepada ON atau OFF secara manual. (Ruj.M-8)
- Paparan Depan dan LED Salur Keluar Udara bertukar kepada ON dan OFF secara automatik mengikut kecerahan bilik. (Apabila kawalan lampu ditetapkan kepada "Auto". Ruj.M-10)
- Apabila Penderia Gerakan tidak mengesan sesiapa di dalam bilik untuk selang masa yang ditetapkan ia menunjukkan bahawa bilik tidak berpenghuni.
- Anda boleh tukar kecerahan bagi Paparan / Pemantau, sensitiviti penderia dan masa pengesanan Penderia Gerakan. (Ruj.M-10)
- Penderia gerakan mungkin mengesan pergerakan selain daripada individu atau haiwan peliharaan. (langsir berkibaran dll.)

Sila baca sebelum mengendalikan Pembersih Udara baru anda

Pembersih udara menyedut udara dalam bilik melalui salur masuk udara, mengalirkannya melalui Prapenapis, Penapis Penyahbau dan Penapis HEPA di dalam unit, kemudian mengeluarkannya melalui salur keluar udara. Penapis HEPA boleh menyingkirkan 99.97% habuk sekecil 0.3 mikron yang dapat melalui penapis dan juga membantu menyerap bau. Penapis Penyahbau menyerap bau sedikit demi sedikit semasa udara mengalir melalui penapis.

Sesetengah bau yang diserap oleh penapis akan terurai lama-kelamaan, menyebabkan bau semakin kuat. Bergantung pada keadaan penggunaan, dan terutama sekali jika produk digunakan dalam persekitaran yang jauh lebih teruk berbanding isi rumah biasa, bau ini mungkin menjadi kuat lebih cepat daripada jangkaan. Jika bau ini berlarutan, ganti penapis. (Ruj. M-13)

Apabila mineral dalam air paip melekat pada penapis serta menjadi keras dan putih, ia akan menyerap bau di dalam bilik yang boleh menyebabkan pengeluaran bau yang tidak menyenangkan apabila penapis pelembam kering. (Berbeza-beza mengikut kualiti air dan faktor persekitaran lain) Jika ini berlaku, jalankan penyelenggaraan penapis pelembam. (Ruj. M-12)

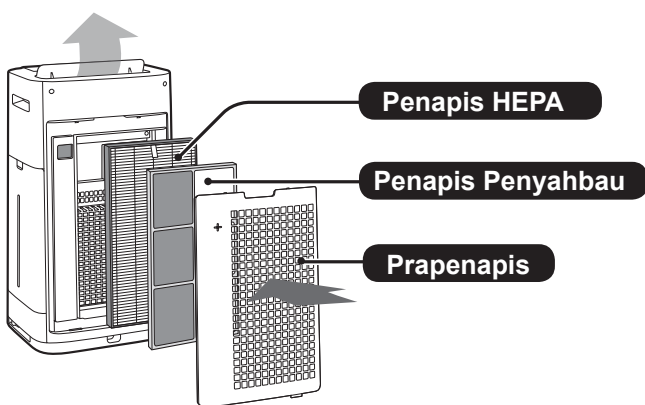

NOTA

- Pembersih udara direka untuk menyingkirkan habuk yang terampai di udara dan bau yang disebabkan. Pembersih udara ini tidak direka untuk menyingkirkan gas-gas berbahaya seperti karbon monoksida yang terkandung dalam asap rokok. Pembersih udara ini mungkin tidak dapat menghapuskan bau sepenuhnya jika sumber bau masih ada di situ.

ISI KANDUNGAN

ARAHAN KESELAMATAN PENTING M-3

- AMARAN
- NOTA
- AMARAN BERKAITAN OPERASI
- GARIS PANDUAN PEMASANGAN
- GARIS PANDUAN PENAPIS

NAMA-NAMA BAHAGIAN M-5

- DEPAN
- BELAKANG
- PANEL OPERASI
- PAPARAN DEPAN

PERSEDIAAN M-7

- PEMASANGAN PENAPIS

OPERASI M-7

- MULA / BERHENTI
- MOD HAZE
- MOD INTELLIGENT (KC-G60 / KC-G50)
- MOD AUTO (KC-G40)
- MOD SPOT PLASMACLUSTER ION
- MEMILIH MOD
- KUNCI KANAK-KANAK
- TETAPAN PELEMBAPAN (MENGISI SEMULA TANGKI AIR)
- PEMASA HIDUP
- PEMASA MATI
- MEMILIH PAPARAN
- PLASMACLUSTER ION ON/OFF
- CARA MENGENDALIKAN TETAPAN PELBAGAI

PENJAGAAN DAN PENYELENGGARAAN M-11

- PENUNJUK PENAPIS
- INDEKS PENJAGAAN
- TANGKI AIR
- UNIT / PANEL BELAKANG
- PENAPIS DAN DULANG PELEMBAP
- PENAPIS HEPA / PENAPIS PENYAHBAU
- PENGGANTIAN PENAPIS

PENGENALPASTIAN DAN PENYELESAIAN MASALAH M-14

SPESIFIKASI M-15

Terima kasih kerana membeli Pembersih Udara SHARP ini. Sila baca manual ini dengan teliti sebelum menggunakan pembersih udara anda. Selepas membacanya, simpan manual, di lokasi yang mudah dicari untuk rujukan pada masa akan datang.

ARAHAN KESELAMATAN PENTING

Sentiasa ikuti langkah keselamatan asas semasa menggunakan perkakas elektrik, termasuk yang berikut:

AMARAN – Sentiasa perhatikan yang berikut untuk mengurangkan risiko kejutan elektrik, kebakaran atau kecederaan:

- Baca semua arahan sebelum menggunakan unit ini.
- Hanya gunakan salur keluar 220~240 volt.
- **Perkakas ini tidak direka untuk digunakan oleh mereka (termasuk kanak-kanak) yang cacat tubuh badan, cacat deria atau mental, mahupun mereka yang kurang berpengalaman dan pengetahuan, kecuali jika mereka diberikan penyeliaan atau arahan yang betul tentang cara penggunaan perkakas oleh orang yang bertanggungjawab atas keselamatan mereka. Kanak-kanak hendaklah diawasi bagi memastikan mereka tidak bermain dengan perkakas ini.**
- Jika kord kuasa rosak, ia mesti digantikan oleh pengilang, wakil servis, Pusat Servis Sharp yang sah atau individu yang berkelayakan sama bagi mengelakkan bahaya.
- Pastikan anda menanggalkan palam kuasa apabila mengisi semula Tangki Air sebelum menjalankan penyelenggaraan, apabila menanggalkan, memasang dan menggantikan penapis serta apabila tidak menggunakannya untuk masa yang lama. Kegagalan melakukan sedemikian akan menyebabkan litar pintas berlaku yang mengakibatkan kejutan elektrik atau kebakaran.
- Jangan gunakan unit ini jika kord kuasa atau palamnya rosak atau jika sambungan ke salur keluar dinding longgar.
- Dari semasa ke semasa buang habuk yang melekat pada palam.
- Jangan masukkan jari atau objek asing ke dalam salur masuk atau salur keluar udara.
- Sentiasa pegang palam dan jangan sesekali tarik kordnya apabila hendak menanggalkan palam kuasa. Kegagalan berbuat demikian boleh menyebabkan litar pintas yang boleh mengakibatkan kejutan elektrik atau kebakaran.
- Apabila mengeluarkan unit ini, jangan biarkan rodanya merosakkan kord kuasa. Kegagalan berbuat demikian boleh menyebabkan kejutan elektrik, penjaan haba atau kebakaran.
- Berhati-hati agar kord kuasa tidak rosak, jika tidak, boleh menyebabkan kejutan elektrik, terlebih panas atau kebakaran.
- Jangan tanggalkan palam dengan tangan yang basah.
- Jangan letakkan unit ini berhampiran perkakas yang menggunakan gas atau tempat berdiang.

- Hanya Pusat Servis Sharp yang Sah boleh menservis pembersih udara ini. Sila hubungi Pusat Servis yang berdekatan bagi sebarang masalah, pelarasan atau pembaikan.
- Jangan kendalikan unit ini di dalam bilik di mana penyembur pembunuh serangga digunakan. Jangan kendalikan unit ini di dalam bilik di mana udaranya berminyak, kemenyan atau setinggi sedang dibakar, terdapat nyalaan api untuk menyalakan rokok atau udaranya berwasap bahan kimia. Jangan kendalikan unit ini di lokasi di mana unit ini mungkin basah, seperti di dalam bilik air.
- Sila berhati-hati semasa membersihkan unit ini. Bahan pencuci yang kuat mengakis boleh merosakkan bahagian luar unit.
- Apabila mengangkat unit ini, keluarkan dahulu Tangki Air dan Dulang Pelembapnya, kemudian pegang unit pada pemegangnya di sebelah kiri dan kanan.
- Jangan minum air di dalam Dulang Pelembap atau Tangki Air.
- Jangan dedahkan unit kepada air. Berbuat demikian boleh menyebabkan litar pintas atau kejutan elektrik.
- Ganti air di dalam Tangki Air setiap hari dengan air bersih dari paip, dan selalulah bersihkan Tangki Air dan Dulang Pelembap (Ruj. M-8, M-11 dan M-12). Apabila unit ini tidak digunakan, buang air di dalam Tangki Air dan Dulang Pelembap. Membiarkan air di dalam Tangki Air atau Dulang Pelembap boleh mengakibatkan kulupuk, bakteria dan bau busuk.
Dalam kes-kes yang jarang berlaku, bakteria sedemikian boleh membahayakan kesihatan.

NOTA – Apa harus dilakukan jika unit mengganggu penerimaan radio atau TV

Jika pembersih udara mengganggu penerimaan radio atau televisyen, cuba satu atau lebih langkahlangkah berikut:

- Ubah atau alih kedudukan antena penerima.
- Jauhkan unit dari radio atau TV.
- Sambungkan alat ini kepada salur keluar pada litar yang berbeza dengan yang bersambung kepada penerima radio atau TV.
- Dapatkan nasihat penjual atau juruteknik radio atau TV yang berkelayakan.

AMARAN BERKAITAN OPERASI

- Jangan halang salur masuk atau keluar udara.
- Jangan letak unit ini berdekatan atau di atas objek panas, seperti dapur masak atau alat pemanas, atau di mana ia mungkin terkena wap air.

- Sentiasa kendalikan unit ini dalam kedudukan menegak.
- Apabila mengalihkan unit ini, gunakan pemegang di kedua-dua sisinya.
Jangan alihkan unit ini semasa ia sedang beroperasi.
- Jika unit ini di atas lantai yang mudah rosak, permukaan yang tidak rata atau permaidani yang tebal, angkat ia semasa mengalihkannya.
- Apabila anda mengalihkan ia menggunakan rodanya, gerakkan perlahan-lahan dalam arah melintang.
- Matikan unit dan keluarkan tangki air sebelum mengalihkannya, berhati-hati agar jari anda tidak tersepit.
- Jangan kendalikan unit ini tanpa penapis, Tangki Air, dan Dulang Pelembapnya terpasang rapi.
- Jangan cuci atau guna semula penapis HEPA dan penapis Penyahbau.
Berbuat demikian tidak akan meningkatkan prestasi penapis dan juga boleh menyebabkan kejutan elektrik atau kepincangan tugas.
- Bersihkan bahagian luarnya dengan kain lembut sahaja. Jangan gunakan cecair yang mudah meruap dan bahan pencuci. Permukaan unit boleh rosak atau merekah dengan pencair cat Benzena atau serbuk penggilap. Selain itu, ia boleh mengakibatkan penderia pincang tugas.
- Kekerasan penyelenggaraan pembuangan kerak kapur bergantung pada kekerasan atau ketaktulenan air yang anda gunakan; semakin keras airnya semakin kerap anda perlu membuang kerak kapurnya.
- Pastikan unit utama jauh dari air.
- Apabila mengisi semula Tangki Air, pastikan tiada air yang bocor daripada Tangki Air.
- Pastikan anda mengelap air yang terpercik di bahagian luar Tangki Air.
- Jangan gunakan air panas (40 °C atau lebih), bahan kimia, bahan beraroma, air kotor atau bahan yang merosakkan. Berbuat demikian boleh mengubah bentuk unit atau menyebabkan ia pincang tugas.
- Gunakan air bersih dari paip sahaja. Menggunakan sumber air lain berisiko yang menyebabkan terbentuknya kulapuk, fungus atau bakteria.
- Jangan biarkan Tangki Air bergoyang-goyang dengan memegang pemegang.
- Jangan tanggalkan Penapis Pelembap dari rangka penapis kecuali ketika menggantikannya.
- Berhati-hati agar air dari Dulang Pelembap tidak tertumpah semasa menanggalkan atau membersihkannya.
- Jangan tanggalkan Pelampung.
Jika ia tertanggal, rujuk M-13.

- Jangan gunakan bahan pencuci untuk penyelenggaraan Dulang Pelembap dan Penutup.
Jika tidak, ia akan menyebabkan bentuk penutup rosak, warnanya menjadi kusam dan terbentuknya rekahan (kebocoran air).
- Jangan sental Panel Belakang dengan kuat semasa menyelenggaranya.

GARIS PANDUAN PEMASANGAN

- Elakkan lokasi di mana penderia terdedah terus kepada angin.
Berbuat demikian boleh menyebabkan unit pincang tugas.
- Elakkan lokasi di mana perabot, fabrik atau barang-barang lain bersentuhan dengan unit dan mengganggu penyedutan dan penghembusan udara.
- Elakkan di lokasi di mana unit ini mungkin terdedah kepada pemeluwapan atau perubahan suhu yang mendadak. Suhu bilik yang sesuai adalah antara 0 – 35 °C.
- Letakkan unit di atas permukaan yang rata dan stabil dengan peredaran udara yang mencukupi.
Apabila diletakkan di atas permaidani yang tebal, unit ini mungkin akan bergetar sedikit.
Letakkan unit ini di atas permukaan yang rata untuk mengelakkan kebocoran air dari Tangki Air dan Dulang Pelembap.
- Elakkan lokasi yang mengeluarkan asap yang bergris atau berminyak.
Berbuat demikian boleh menyebabkan bahagian luar unit merekah dan penderia pincang tugas.
- Keupayaan unit mengumpul habuk berkesan apabila unit berada hampir 3 cm dari dinding, sekitar dinding dan lantai yang kotor. Sila letakkan unit jauh dari dinding.
Dinding yang berada betul-betul di belakang salur keluar udara mungkin akan menjadi kotor lama-kelamaan. Jika menggunakan unit ini di lokasi yang sama untuk tempoh yang lama, bersihkan dinding yang bersebelahan dengannya dari semasa ke semasa.

GARIS PANDUAN PENAPIS

- Ikut arahan di dalam manual ini untuk penjagaan dan penyelenggaraan penapis yang betul.
(Ruj. M-11, M-12 dan M-13)

NAMA-NAMA BAHAGIAN

DEPAN

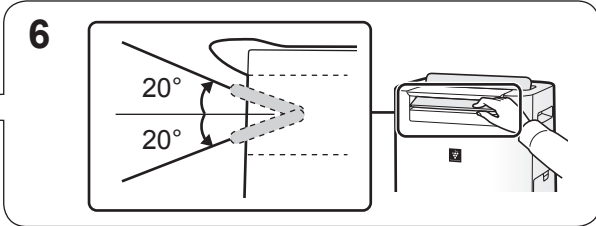
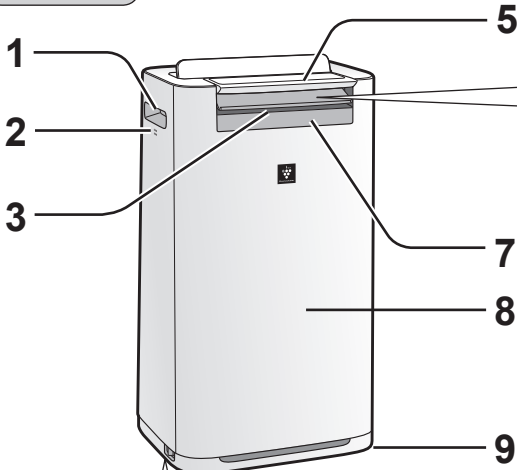

1	Pemegang (2 Tempat)
2	Penderia (Di dalam) Suhu / Kelembapan / Bau* (*KC-G60 / KC-G50)
3	Salur Keluar Udara (Depan)
4	Penahan Roda (Kanan & Kiri)
5	Panel Operasi
6	Ram Depan (Boleh Laras)
7	Paparan Depan
8	Unit
9	Roda (4 Tempat)

4 Untuk mengunci penahan roda (Kanan & Kiri)

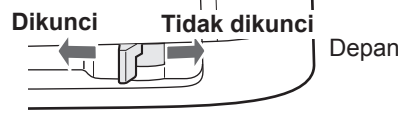

BELAKANG

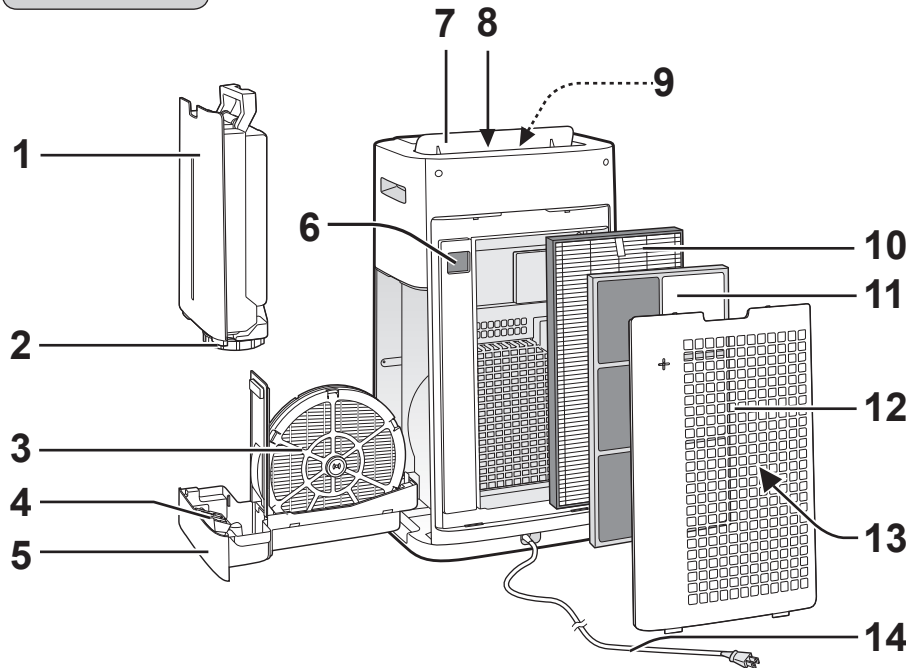

(Bentuk palam berbeza-beza mengikut negara.)

1	Tangki Air	7	Ram Belakang
2	Penutup Tangki	8	Salur Keluar Udara (Belakang)
3	Penapis Penyahbau	9	LED Salur Keluar Udara (Putih)
4	Pelampung	10	Penapis HEPA
5	Dulang Pelembap	11	Penapis Penyahbau
6	Habuk (sensitif) Penderia / Penapis Penderia	12	Panel Belakang (Prapenapis)
		13	Salur Masuk Udara
		14	Kord / Palam Kuasa

Julat pengesanan

Lampu Penderia

Jangan pasang unit di tempat berikut.
Lampu Penderia mungkin tidak dapat mengesan dengan betul.

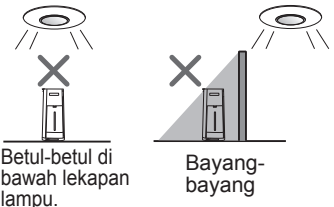

Betul-betul di bawah lekapan lampu.

Bayang-bayang

Penderia Gerakan (KC-G60 / KC-G50)

Julat penderia dalam kawasan ditunjukkan di bawah.

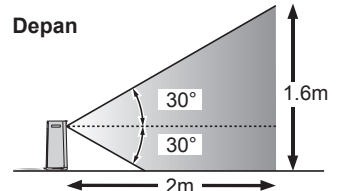

Kanan & Kiri

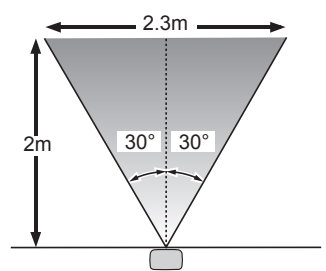

PANEL OPERASI

Tekan butang dengan "★" untuk mula.

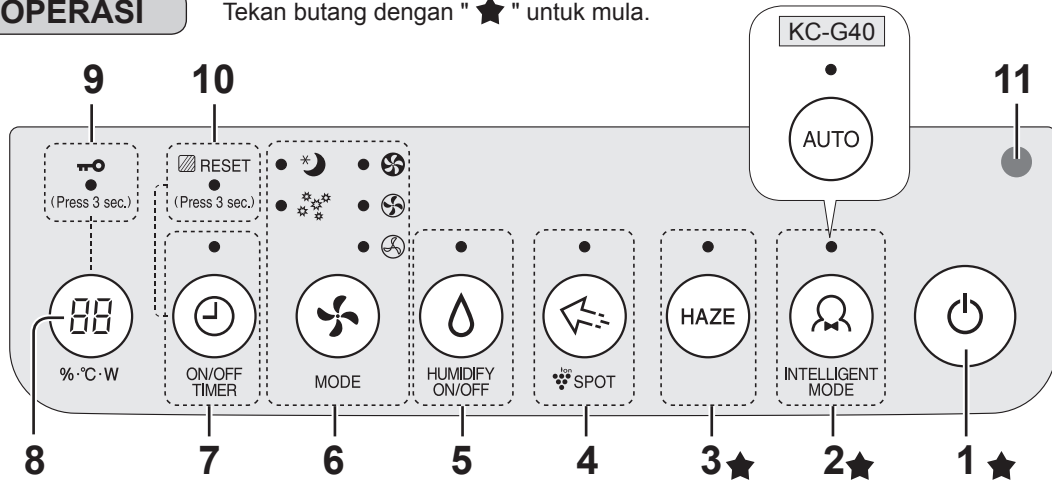

1	Butang POWER ON / OFF	7	Butang ON / OFF TIMER, Lampu Penunjuk (Putih) <Tekan 3 saat> Butang FILTER RESET
2	Butang INTELLIGENT MODE, Lampu Penunjuk (Putih)	8	Butang DISPLAY SELECT <Tekan 3 saat> Butang CHILD-LOCK
3	Butang HAZE, Lampu Penunjuk (Putih)	9	Lampu Penunjuk CHILD-LOCK (Putih)
4	Butang SPOT Plasmacluster Ion, Lampu Penunjuk (Putih)	10	Lampu Penunjuk FILTER RESET (Jingga)
5	Butang HUMIDIFY ON / OFF, Lampu Penunjuk (Putih)	11	Lampu Penderia
6	Butang MODE, Lampu Penunjuk (Putih)		

PAPARAN DEPAN

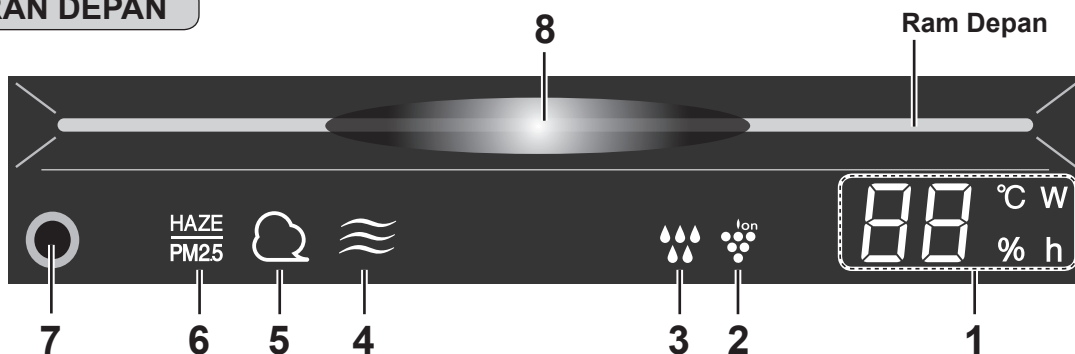

1	Pemantau Kelembapan / Suhu Menunjukkan anggaran paras kelembapan atau suhu di dalam bilik. Tetapan kelembapan tidak boleh dilaraskan. Kelembapan 20% hingga 90% dipaparkan. 20% atau kurang ← 55% → 90% atau lebih Suhu 0°C hingga 50°C dipaparkan. -10c atau kurang ← 25°C → 50c atau lebih Pemantau Watt Menunjukkan watt mengikut operasi semasa. Pemantau Pemasa Menunjukkan masa tetapan atau masa yang tinggal bagi pemasa ON/OFF.	4	Lampu Bau (Putih) (KC-G60 / KC-G50) Menunjukkan Penderia Bau mengesan bau.	
	2	Lampu Plasmacluster Ion (Biru)	5	Lampu Habuk (Putih) Menunjukkan Penderia Habuk(sensitif) mengesan habuk biasa.
	3	Lampu Kelembapan Hijau Kelembapan HIDUP Off Kelembapan MATI Merah (Berkelip-kelip.) Unit memerlukan air	6	Lampu HAZE / PM2.5 (Putih) Menunjukkan Penderia Habuk(sensitif) mengesan habuk mikroskopik.
		7	Penderia Gerakan (KC-G60 / KC-G50)	
		8	Pemantau Kebersihan Menunjukkan ketulenan udara bilik mengikut 7 tahap dengan perubahan warna. Biru Bersih ⇕ Merah Kotor	

PERSEDIAAN

Pastikan anda menanggalkan palam kuasa dari soket dinding.



PEMASANGAN PENAPIS

1 Tanggalkan Panel Belakang.

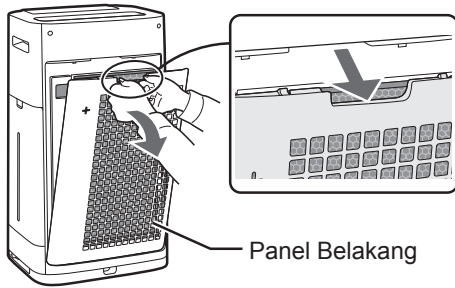

2 Tanggalkan beg plastik daripada setiap penapis.

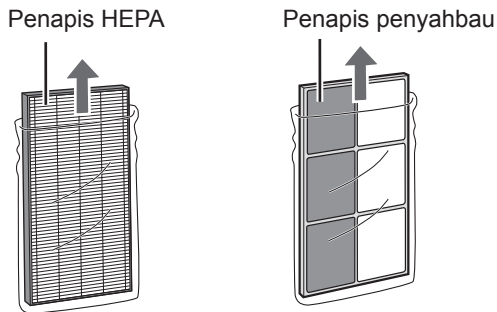

3 Pasang penapis dengan urutan yang betul seperti yang ditunjukkan.

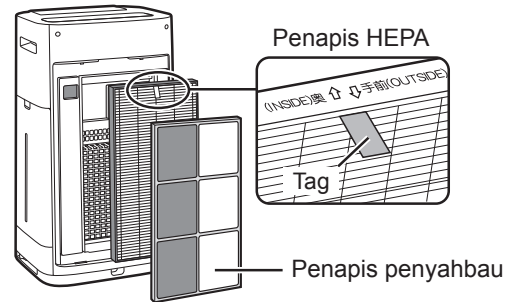

4 Pasang Panel Belakang.

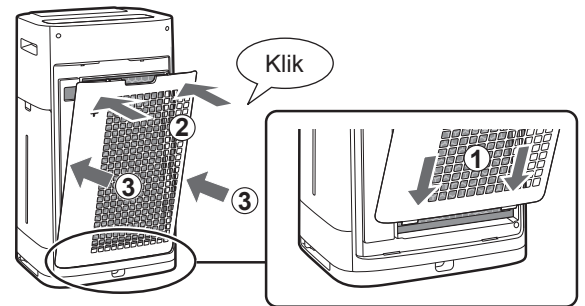

NOTA

- Apabila menggantikan penapis, anda disyorkan membuat memo bagi tarikh permulaan penggunaan.

OPERASI

MULA/BERHENTI

MULA

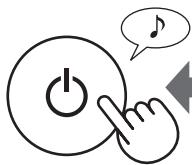

BERHENTI

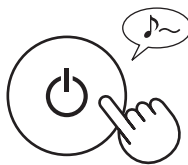

MOD HAZE

Kipas beroperasi pada kelajuan TINGGI selama 60 minit dan bertukar-tukar antara tahap Rendah dan Tinggi selama 20 minit untuk setiap tahap tersebut.

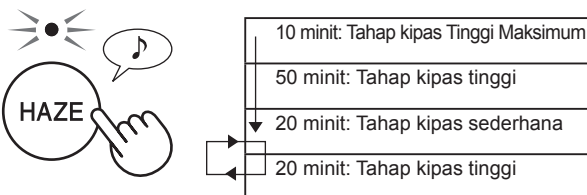

NOTA

- Plasmacluster Ion tidak boleh ditukar kepada "OFF". (Ruj. M-9)

MOD INTELLIGENT (KC-G60 / KC-G50)

Kelajuan kipas dikawal secara automatik bergantung pada 7 pengesanan. (Ruj. M-1)

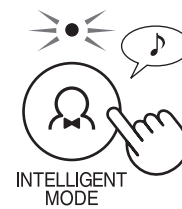

MOD AUTO (KC-G40)

Kelajuan kipas dikawal secara automatik bergantung pada 5 pengesanan. (PM2.5 / Habuk biasa / Suhu / Kelembapan / Lampu)

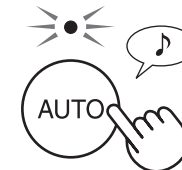

NOTA

- Paparan Depan, Pemantau Kebersihan dan LED Salur Keluar Udara bertukar kepada ON dan OFF secara automatik mengikut kecerahan bilik. (Apabila kawalan lampu ditetapkan kepada "Auto". Ruj.M-10)

PLASMACLUSTER ION MOD SPOT

Guna mod ini apabila anda ingin tanggalkan bau yang melekat, kuman dan bahan lain daripada pakaian, sofa serta langsir.

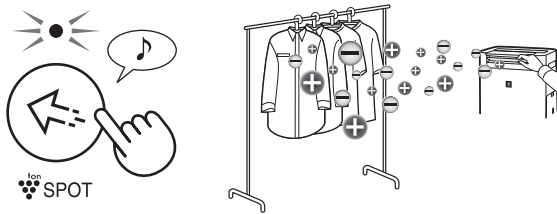

NOTA

Laraskan Ram Depan secara manual.

- Hanya mengeluarkan Plasmacluster Ion ke arah hadapan.
- Mengeluarkan udara yang lebih kuat selama 8 jam. Apabila operasi tamat, unit ini akan kembali kepada mod operasi sebelumnya.
- Plasmacluster Ion tidak boleh ditukar kepada "OFF". (Ruj. M-9)

MEMILIH MOD

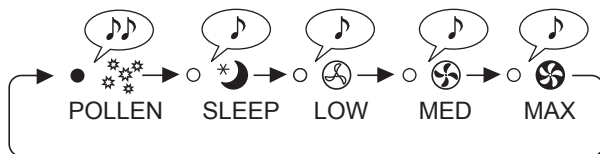
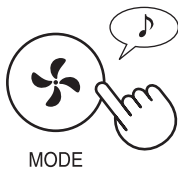

NOTA

SLEEP

Unit akan beroperasi dengan sangat senyap dan kelajuan kipas bertukar secara automatik bergantung pada jumlah kekotoran dalam udara.

Paparan Depan, Pemantau Kebersihan dan LED Salur Keluar Udara dimatikan secara automatik.

(Apabila kawalan lampu ditetapkan kepada "Auto". Ruj.M-10)

POLLEN

Sensitiviti PENDERIA HABUK ditetapkan kepada "HIGH" secara automatik dan mengesan dengan cepat kekotoran seperti habuk dan debunga serta membersihkan udara dengan sangat berkesan.

KUNCI KANAK-KANAK

Operasi bagi panel operasi akan dikunci.

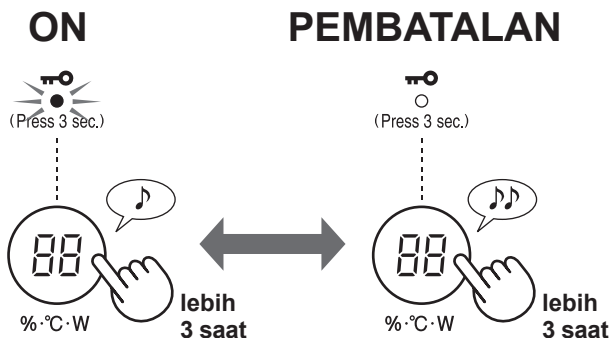

TETAPAN PELEMBAPAN

MENGENGI SEMULA TANGKI AIR

1 Keluarkan Tangki Air.

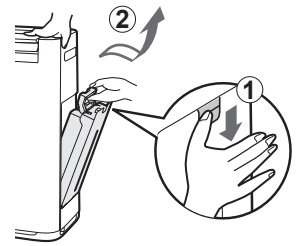

2 Isikan Tangki Air dengan air paip.

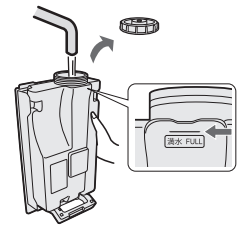

3 Untuk mencegah kebocoran, ketatkan Penutup Tangki dengan selamat.

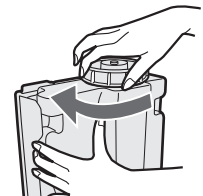

4 Pasang Tangki Air.

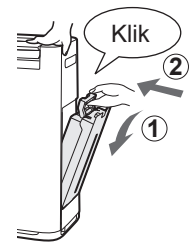

ON



OFF



NOTA

Apabila beroperasi dalam mod Kelembapan ON seperti dalam jadual di bawah, unit secara automatiknya mengawal kelembapan dengan mengesan suhu dan kelembapan. (Kecuali mod MAX / MED / LOW.)

Suhu	Kelembapan	
	SEMUA MOD (Kecuali MAX / MED / LOW / SLEEP)	MOD POLLEN
~18 °C	65 %	65 %
18 °C~24 °C	60 %	65 %
24 °C~	55 %	60 %

PEMASA HIDUP

Pilih panjang masa yang diinginkan. Unit akan bermula secara automatik sebaik sahaja masa yang dipilih berlalu.

(semasa unit OFF)

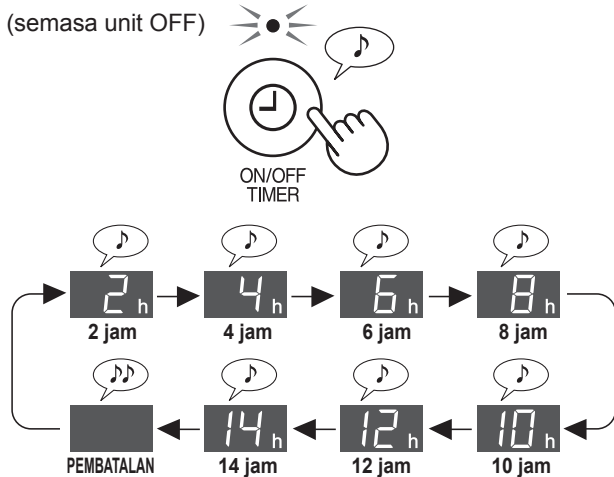

PEMASA MATI

Pilih panjang masa yang diinginkan. Unit akan berhenti secara automatik sebaik sahaja masa yang dipilih dicapai.

(semasa unit ON)

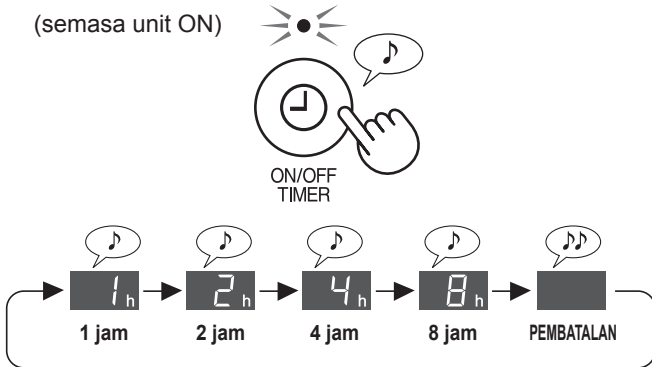

MEMILIH PAPARAN

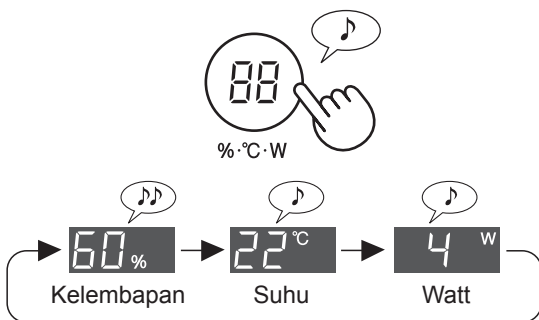

PLASMACLUSTER ION ON/OFF

Apabila fungsi Plasmacluster ON, Lampu Plasmacluster Ion pada Paparan Depan akan menyala. (Ruj. M-6)

(semasa unit ON)

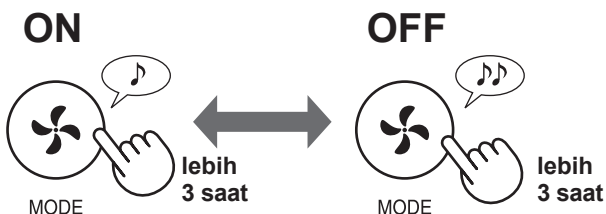

CARA MENGUBAH PELBAGAI

Anda boleh ubah fungsi dalam jadual "Jenis tetapan" pada muka surat seterusnya.

1 Matikan unit kuasa dengan menekan butang kuasa OFF.



3 Pilih "Nombor fungsi" daripada jadual pada muka surat seterusnya.

Ke depan

Ke belakang

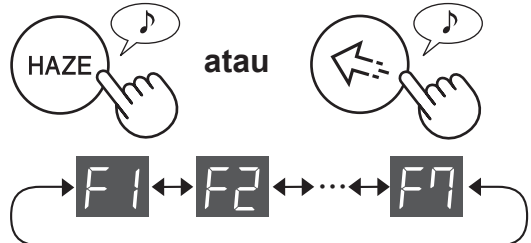

Tetapan

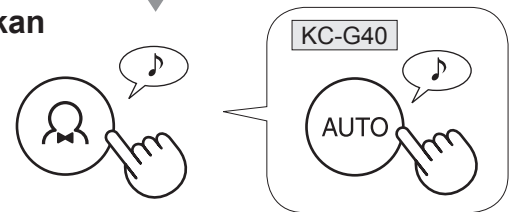

4 Pilih "Nombor tetapan" daripada jadual pada muka surat seterusnya.

Ke depan

Ke belakang

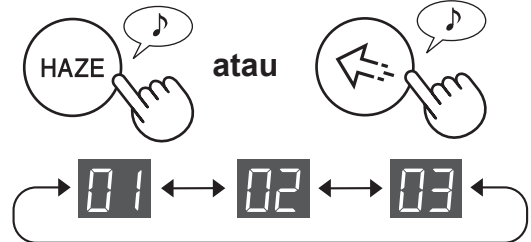

Tetapan

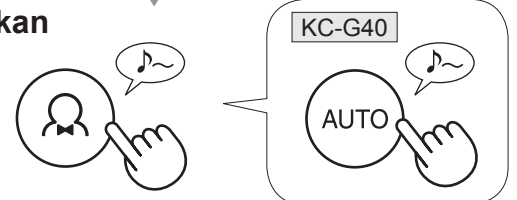

5 Tekan butang Power untuk tamatkan tetapan.

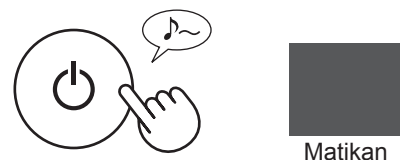

TETAPAN

Jenis tetapan

Fungsi	Tetapan
<p>Kawalan Lampu</p> <p>Anda boleh pilih kecerahan Paparan Depan, Pemantau Kebersihan dan LED Salur Keluar Udara.</p> <p style="text-align: right;">F1</p>	<p>01 Auto (lalai) Lampu bertukar kepada ON atau OFF secara automatik mengikut kecerahan bilik. Bilik cerah: lampu ON Bilik gelap: lampu OFF</p> <p>02 Darker</p> <p>03 Matikan</p> <ul style="list-style-type: none"> • Apabila ditetapkan kepada "Matikan", lampu "Darker" menyala selama 3 saat selepas operasi bermula dan kemudian lampu dimatikan. • Lampu Kelembapan hanya berkelip lebih gelap apabila unit memerlukan air.
<p>Tetapan Penunjuk Bunyi</p> <p>Anda boleh tetapkan unit agar mengeluarkan bunyi bip apabila Tangki Air kosong.</p> <p style="text-align: right;">F2</p>	<p>01 Pembatalan (lalai)</p> <p>02 ON</p>
<p>Mula Semula Auto</p> <p>Jika palam unit dicabut atau jika bekalan kuasa terputus, unit akan menyambung semula operasi dengan tetapan terakhir yang digunakan selepas bekalan kuasa bersambung semula.</p> <p style="text-align: right;">F3</p>	<p>01 Pembatalan</p> <p>02 ON (lalai)</p>
<p>Melaraskan Sensitiviti Penderia (F4-F7)</p> <p>Lampu Penderia F4</p> <hr/> <p>Penderia Habuk(sensitif) F5</p> <hr/> <p>Penderia Bau (KC-G60 / KC-G50) F6</p> <hr/> <p>Penderia Gerakan (KC-G60 / KC-G50) F7</p> <p>Anda boleh tetapkan masa sehingga Penderia Gerakan mengesan tiada sesiapa di dalam bilik. Anda juga boleh batalkan pengesanan Penderia Gerakan.</p>	<p>01 Rendah</p> <p>02 Standard (lalai)</p> <p>03 Tinggi</p> <hr/> <p>01 ON (Masa pengesanan standard) (lalai)</p> <p>02 ON (Masa pengesanan lebih panjang)</p> <p>03 Pembatalan</p>

PENJAGAAN DAN PENYELENGGARAAN



PENUNJUK PENAPIS

Lampu Penunjuk penapis akan menyala selepas kira-kira 720 jam. (30 hari × 24 jam = 720 jam)

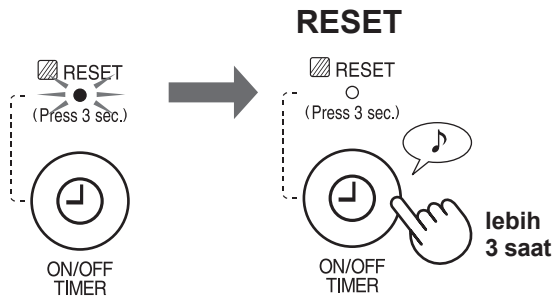

Ini adalah peringatan agar menjalankan penyelenggaraan seperti yang diterangkan di bawah. Selepas menjalankan penyelenggaraan, setkan semula Penunjuk Penapis.

INDEKS PENJAGAAN

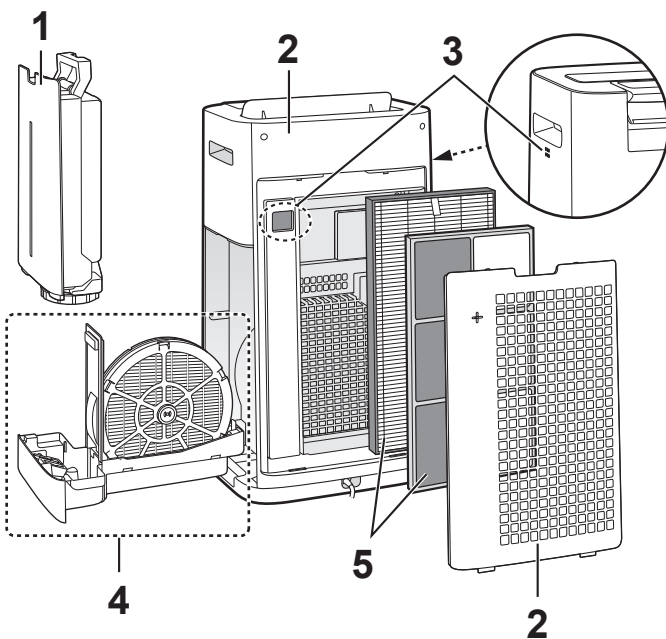

	Tempat	Ruj.
1	Tangki Air	M-11
2	Unit / Panel Belakang (Prapenapis)	
3	Penderia	
4	Penapis Pelembap Dulang Pelembap	M-12
5	Penapis HEPA Penapis penyahbau	M-13

TANGKI AIR



Bilas bahagian dalamnya dengan air.

NOTA Cara membersihkan kotoran degil.

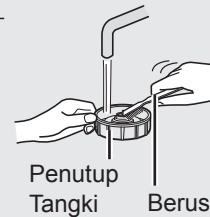
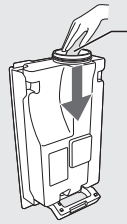

Bersihkan bahagian dalam Tangki Air dengan span yang lembut dan Penutup Tangki dengan putik kapas atau berus gigi.

Penutup Tangki
Berus gigi

UNIT / PANEL BELAKANG

Lap dengan kain kering yang lembut.



Penderia

Panel Belakang (Prapenapis)

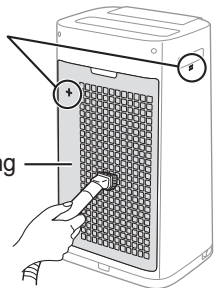

Buang habuk dengan perlahan-lahan menggunakan alat pembersih seperti pembersih hampagas.

NOTA Cara membersihkan kotoran degil.

Panel Belakang

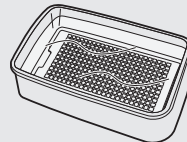

1. Tambah sedikit bahan pencuci pinggan ke dalam air dan rendam selama kira-kira 10 minit.

AWAS

Jangan kenakan tekanan yang berlebihan semasa menyental panel belakang.

2. Bilas bahan pencuci pinggan itu dengan air bersih.
3. Keringkan sepenuhnya penapis di kawasan yang mempunyai pengalihan udara yang baik.

Penapis Penderia

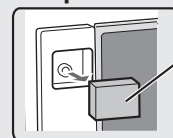

Penapis Penderia

1. Tanggalkan Panel Belakang.
2. Tanggalkan penapis penderia.
3. Jika penapis penderia sangat kotor, cucinya dengan air dan keringkan ia sepenuhnya.

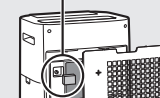

PENAPIS DAN DULANG PELEMBAP

CARA MENANGGALKAN PENAPIS DAN DULANG PELEMBAP.

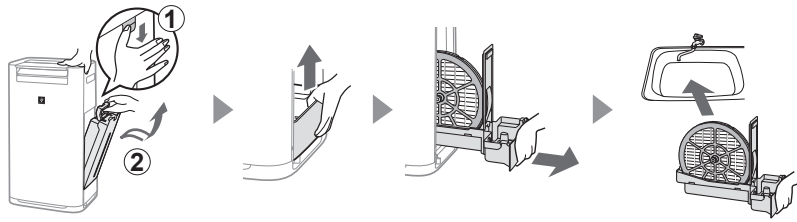

CARA MEMASANG PENAPIS PELEMBAP DAN DULANG PELEMBAP.

Selepas penyelenggaraan, pasang semula bahagian-bahagian yang ditanggalkan dengan betul.

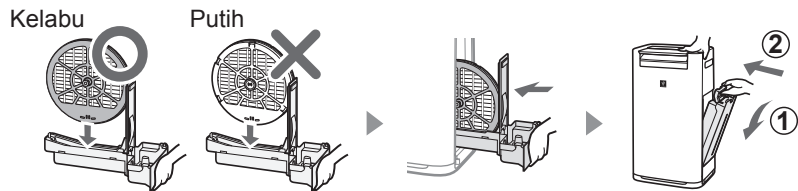

Penapis Penyahbau

Bilas dengan air yang banyak.

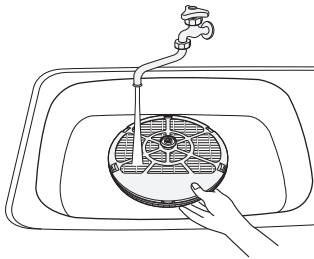

NOTA

Jika anda tanggalkan aci Penapis Pelembap, pastikan anda pasanginya semula ke kedudukan asal.

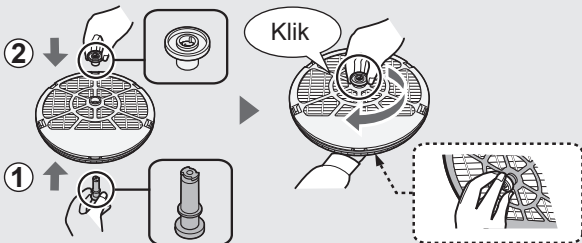

Dulang Pelembap

1 Tanggalkan Penutup Dulang Pelembap.

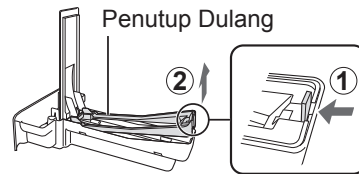

2 Bilas dengan air yang banyak.

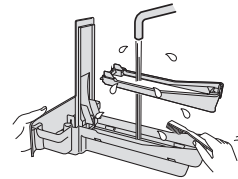

3 Pasang Semula Penutup Dulang Pelembap.

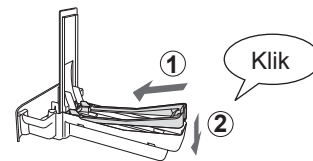

• Jangan tanggalkan Pelampung dan Panel Dulang. Jika ia tertanggal, rujuk M-13.

NOTA Cara membersihkan kotoran degil.

	Bahan pencuci pinggan (dulang Pelembap sahaja)	Asid sitrik (ada dijual di sesetengah kedai ubat)	100% jus lemon tanpa isi dalam botol
1	1. Isikan air ke dalam dulang, separuh penuh. 2. Tambah sedikit bahan pencuci pinggan.	2 1/2 cawan air 3 sudu teh	3 cawan air 1/4 cawan
2	Rendam selama 30 minit.	Rendam selama 30 minit.	Rendam selama 30 minit. (Jika anda menggunakan jus lemon sebagai larutan penanggal kerak kapur, rendam lebih lama.)
3	Bilas bahan pencuci pinggan atau larutan penanggal kerak kapur dengan air bersih.		

PENAPIS HEPA / PENAPIS PENYAHBAU

Buang habuk pada Penapis HEPA dan Penapis Penyahbau.

AWAS

- Jangan basuh penapis. Jangan dedahkan kepada cahaya matahari.

PENAPIS HEPA

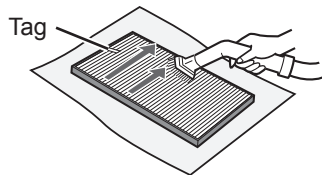

Selenggara permukaan yang ditandakan sahaja. Jangan bersihkan permukaan bertentangan. Penapis mudah patah, jadi jangan kenakan terlalu banyak tekanan padanya.

PENAPIS PENYAHBAU

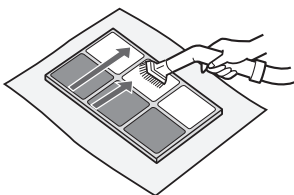

Kedua-dua permukaan boleh diselenggara. Penapis mungkin boleh patah jika terlalu banyak tenaga dikenakan ke atasnya, jadi sila kendalikannya dengan baik.

Sesetengah bau yang diserap oleh penapis akan terurai lama-kelamaan, menyebabkan bau semakin kuat. Bergantung pada keadaan penggunaan, dan terutama sekali jika produk digunakan dalam persekitaran yang jauh lebih teruk berbanding isi rumah biasa, bau ini mungkin menjadi kuat lebih cepat daripada jangkaan.

Gantikan penapis dalam bekas itu atau jika habuk tidak boleh dibuang selepas diselenggara.

Cara untuk pasang Pelampung dan Panel Dulang

Panel dulang

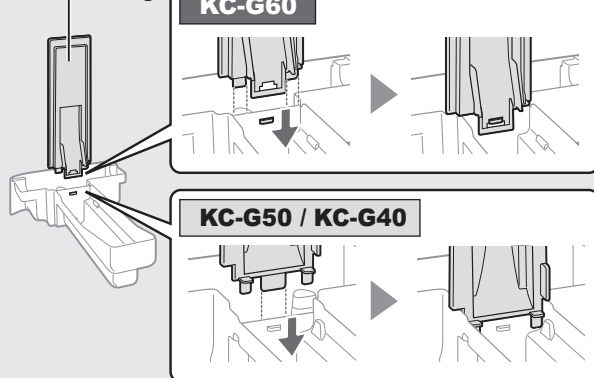

Pelampung

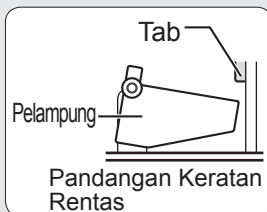

1. Masukkan pelampung di bawah tab ini.

3. Masukkan tab di bahagian pelampung yang lagi satu ke dalam lubang.

2. Masukkan tab pelampung ke dalam lubang.

PENGGANTIAN PENAPIS

HAYAT PENAPIS

Jangka hayat penapis berbeza-beza bergantung pada persekitaran bilik, keadaan penggunaan dan lokasi unit ini. Jika habuk dan bau gagal disingkirkan, ganti penapis. Jangka hayat penapis HEPA dan penapis Penyahbau serta cadangan penggantian berdasarkan pembersihan bilik yang dipenuhi asap rokok sebanyak 5 batang sehari dan prestasi pengumpulan habuk dan penyahbauan unit telah menurun separuh daripada tahap penapis baru. Kami mengesyorkan agar anda menggantikan penapis dengan lebih kerap jika unit digunakan dalam keadaan yang jauh lebih teruk (HAZE dll ,) daripada penggunaan biasa di rumah.

- Penapis HEPA Lebih kurang 10 tahun selepas mula digunakan
- Penapis Penyahbau Lebih kurang 10 tahun selepas mula digunakan
- Penapis Pelembap Lebih kurang 10 tahun selepas mula digunakan

Model Penapis Ganti

Berundinglah dengan penjual apabila hendak membeli penapis.

MODEL PEMBERSIH UDARA	KC-G60	KC-G50	KC-G40
Penapis HEPA (1 unit)	FZ-D60HFE	FZ-D40HFE	FZ-D40HFE
Penapis Penyahbau (1 unit)	FZ-G60DFE	FZ-G40DFE	FZ-G40DFE
Penapis Pelembap (1 unit)	FZ-G60MFE	FZ-G60MFE	FZ-G60MFE

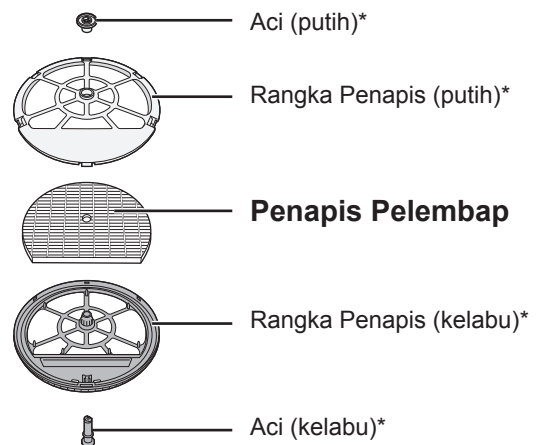

*Jangan dedahkan bahagian ini.

Membuang penapis

Buang penapis terpakai mengikut mana-mana undang-undang dan peraturan tempatan.

Bahan Penapis HEPA:

- Penapis: Polipropilena
- Rangka: Poliester

Bahan Penapis Penyahbau:

- Penapis: Kertas
- Rangka: Resin ABS

Bahan Penapis Penyahbau:

- Penapis: Rayon, poliester



PENGENALPASTIAN DAN PENYELESAIAN MASALAH

Sebelum menghubungi wakil servis, semak carta pengenalanpastian dan penyelesaian masalah di bawah bagi memastikan masalah anda itu mungkin bukan kepincangan tugas unit.

TANDA	CARA MEMULIHKAN (yang berikut bukan disebabkan oleh pincang tugas)
Bau dan asap gagal dilenyapkan.	<ul style="list-style-type: none"> Periksa penapis. Jika penapis sangat kotor, bersihkan atau ganti baru. (Ruj. M- 13).
Pemantau Kebersihan berwarna biru walaupun udara tidak bersih.	<ul style="list-style-type: none"> Udara mungkin kotor semasa palam unit dicucukkan. Cabut palam unit, tunggu seminit, dan pasang semula palamnya.
Lampu Pemantau Kebersihan berwarna merah walaupun udara bersih.	<ul style="list-style-type: none"> Bukaan penderia yang kotor atau dipenuhi habuk(sensitif) mengganggu operasi penderia. Bersihkan penapis penderia atau panel belakang dengan perlahan-lahan. (Ruj. M-11).
Unit mengeluarkan bunyi 'klik' atau 'tik'.	<ul style="list-style-type: none"> Unit ini mungkin mengeluarkan bunyi 'klik' atau 'tik' semasa ia menjana ion.
Udara yang dikeluarkan dari unit berbau.	<ul style="list-style-type: none"> Periksa jika penapis sangat kotor. Bersihkan atau ganti penapis. (Ruj. M-11, M-12 dan M-13) Gunakan air bersih dari paip sahaja. Menggunakan sumber air lain berisiko yang menyebabkan terbentuknya kulapuk, fungus atau bakteria.
Unit tidak beroperasi apabila terdapat asap rokok dalam udara.	<ul style="list-style-type: none"> Pastikan unit ini dipasang di lokasi yang penderia boleh mengesan asap rokok. Periksa jika bukaan penderia habuk(sensitif) terhalang atau tersumbat. Jika ia terhalang atau tersumbat, bersihkan penapis penderia atau panel belakang. (Ruj. M-11)
Lampu Penunjuk FILTER RESET menyala.	<ul style="list-style-type: none"> Selepas melakukan penyelenggaraan atau menggantikan penapis, sambungkan kord kuasa ke salur keluar dan kemudian tekan Butang Tetapan Semula Penapis. (Ruj. M-11)
Paparan Depan dimatikan.	<ul style="list-style-type: none"> Apabila kawalan Lampu ditetapkan kepada "Auto", lampu dimatikan secara automatik apabila bilik menjadi gelap. Selain itu, apabila Lampu kawalan ditetapkan kepada "Matikan", lampu sentiasa dimatikan. Jika anda tidak ingin lampu dimatikan, tetapkan kawalan Lampu kepada tetapan "Darker". (Ruj. M-9, M-10)
Lampu Kelembapan pada Paparan Depan tidak menyala apabila tangki kosong.	<ul style="list-style-type: none"> Bilik telah mencapai tahap kelembapan yang sesuai dan pelembap dihentikan. Periksa pelampung stirofoam jika ada kekotoran. Bersihkan Dulang Pelembap. Pastikan unit terletak di atas permukaan rata. (Ruj. M-12)
Paras air di dalam tangki tidak menurun atau menurun dengan amat perlahan.	<ul style="list-style-type: none"> Periksa dan lihat jika Dulang Pelembap dan Tangki Air dipasang dengan betul. Periksa Penapis Pelembap. (Ruj. M-12) Jika penapis sangat kotor, bersihkan atau ganti baru. (Ruj. M-13)
Pemantau Kebersihan bertukar warna dengan kerap.	<ul style="list-style-type: none"> Pemantau Kebersihan bertukar warna secara automatik apabila penderia habuk(sensitif) dan penderia bau mengesan kekotoran. Jika anda mengambil berat tentang pertukaran, anda boleh tukar sensitiviti penderia. (Ruj. M-9, M-10) (*KC-G60 / KC-G50)
Terdapat percanggahan antara Pemantau Kelembapan unit dan higrometer lain di dalam bilik.	<ul style="list-style-type: none"> Terdapat perbezaan dalam tahap kelembapan di dalam bilik yang sama. Penderia mempunyai parameter pengukuran yang berbeza. Jika pemantau menunjukkan watt atau suhu, tukar paparan dengan menekan butang DISPLAY SELECT. (Ruj. M-9)
Unit HAZE / Lampu PM2.5 tidak sepadan dengan laporan cuaca atau data PM2.5 tempatan lain.	<ul style="list-style-type: none"> Persekitaran di luar dan di dalam rumah (keadaan trafik berhampiran, bilangan tingkat rumah, dll.) boleh menyebabkan bacaan berbeza daripada data PM2.5 tempatan.

PAPARAN RALAT

Sekiranya ralat terus berlaku, hubungi Pusat Servis Sharp.

PENUNJUK DIGITAL	CARA MEMULIHKAN
	Pastikan Penapis Pelembap dan Dulang Pelembap dipasang dengan betul dan kemudian hidupkan kuasa sekali lagi.
	Cabut palam unit, tunggu seminit dan pasang semula palamnya.

SPESIFIKASI

Model		KC-G60			KC-G50			KC-G40		
Bekalan kuasa		220-240 V 50-60 Hz								
Pelarasan Kelajuan Kipas		MAX	MED	LOW	MAX	MED	LOW	MAX	MED	LOW
CLEAN AIR	Kelajuan Kipas (m ³ /jam)	408	240	72	306	180	60	240	120	60
	Kuasa Terkadar (W)	82	38	5.0	58	26	5.0	33	12	5.0
	Paras Hingar (dBA)	55	40	7.0	52	47	19	46	41	19
CLEAN AIR & HUMIDIFY	Kelajuan Kipas (m ³ /jam)	342	240	72	240	120	60	210	120	60
	Kuasa Terkadar (W)	55	40	7.0	32	28	7.0	22	14	7.0
	Paras Hingar (dBA)	53	48	25	46	40	20	43	40	20
	Pelembapan (mL/jam) *1	630	470	200	450	300	150	400	300	150
Saiz Bilik Disyorkan (m ²) *2		~50			~38			~29		
Saiz bilik yang disyorkan bagi Ion Plasmacluster berketumpatan tinggi (m ²) *3		~35			~28			~21		
Kapasiti Tangki Air (L)		3.0			2.5			2.5		
Penderia		Habuk(sensitif) / Bau / Lampu / Suhu & Kelembapan / Gerakan						Habuk(sensitif) / Lampu / Suhu & Kelembapan		
Panjang kord (m)		2.0								
Ukuran (mm)		370 (L) × 293 (D) × 660 (T)			345 (L) × 262 (D) × 631 (T)			345 (L) × 262 (D) × 631 (T)		
Berat (kg)		10.4			8.9			8.9		

- *1 • Jumlah pelembapan berubah mengikut suhu dan kelembapan di dalam dan di luar.
 Jumlah pelembapan meningkat apabila suhu meningkat atau kelembapan menurun.
 Jumlah pelembapan menurun apabila suhu menurun atau kelembapan meningkat.
 • Keadaan Pengukuran: 20 °C, 30 % kelembapan (JEM 1426)
- *2 • Saiz bilik yang disyorkan ialah saiz yang boleh dilembapkan apabila kipas unit ini dikendalikan pada kelajuan maksimum.
 • Saiz bilik yang disyorkan ialah luas di mana sejumlah zarah habuk dapat disingkirkan dalam masa 30 minit.
- *3 • Saiz bilik di mana lebih kurang 7000 ion boleh diukur per sentimeter persegi di tengah-tengah bilik apabila produk ini diletakkan di sebelah dinding, dan beroperasi pada tetapan MED, pada ketinggian lebih kurang 1.2 meter dari lantai.

Kuasa Tunggu Sedia

Apabila palam kuasa unit dicucukkan ke soket dinding ia menggunakan lebih kurang 0.6 watt kuasa tunggu sedia bagi mengendalikan litar elektrik.
 Bagi penjimatan tenaga, tanggalkan kord kuasa jika unit tidak digunakan.

MEMO

特点

空气处理技术的独特组合
三重过滤系统 + 净离子群 + 加湿功能

吸附灰尘
前置过滤网吸附粒径大于 240 微米的尘粒。

减少异味
活性炭过滤网吸收雾霾*1中的有害气体及家中许多常见异味。

减少花粉和霉菌*2
HEPA 过滤网能够吸附高达 99.97% 的粒径小至 0.3 微米的粒子。

空气净化
净离子群对空气进行处理的方法，类似于自然界通过释放平衡浓度的正、负离子而对环境进行净化的过程。

加湿功能
通过自动感应温度和湿度来控制湿度。

*1: 甲苯等。对 1 m³ 测试容器内散发出异味的某种单一物质的除臭效果可能与实际使用中的除臭效果不同。

*2: 空气通过该过滤系统循环时

感应器技术持续侦测空气质量和室内条件，自动调节其运行。

智能模式

(KC-G60 / KC-G50)

6 个感应器全方位感应 7 要素，实现精准控制和自动工作。



有人或宠物位于感应区域内时*4 (*4: 请参见 C-5页)

- 人或宠物动作幅度很小时 (例如: 睡眠时), 自动切换到安静气流。
- 室内光线较暗时, 正面显示屏、清洁度侦测器和吹出口 LED 灯自动关闭。

感应区域内无移动时

- 正面显示屏、清洁度侦测器和吹出口 LED 关闭, 加湿停止, 本机切换至最弱气流, 以节约用电。
- 当室内湿度高于 80% 且光线明亮时, “净离子群” 发射出强气流。

6 个感应器实现 7 种探测

感应器	探测
灰尘 (灵敏)	PM2.5 (粒径小于 2.5 微米的颗粒物) 等
	烟草烟雾、室内尘埃 (灰尘、螨虫粪便及残骸、霉菌孢子和花粉)
异味	烟草、化妆品、酒精、喷雾剂及其他异味。
温度	室温
湿度	室内湿度
光亮	室内亮度
动作*3	人或宠物的移动

*3: 仅在智能工作模式下才可感应。

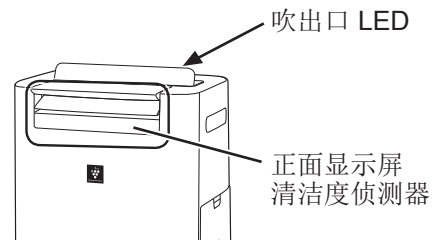

注意

- 智能模式下, 可以手动打开或关闭加湿功能 (请参见 C-8 页)。
- 正面显示屏和吹出口 LED 灯根据室内亮度自动打开或关闭。(当灯光控制按钮设置为“自动 (Auto)”时。请参见 C-10 页)
- 当动作感应器在设定时间内感应到室内无人时, 则认定房间中没有人。
- 可以改变显示屏/侦测器亮度、感应器灵敏度和动作感应器的感应时间。(请参见 C-10 页)
- 动作感应器可以感应到除人或宠物以外的其他移动。(摆动的窗帘等)

SHARP 空气净化器操作原理

空气净化器经吸气口吸入室内空气，使其通过本机内的前置过滤网、活性炭过滤网和 HEPA 过滤网，然后从吹出口排出。当空气通过时，HEPA 过滤网能够去除高达 99.97% 的、粒径小至 0.3 微米的灰尘粒子，同时还能帮助吸收异味。当异味成分经过活性炭过滤网时，便逐步被其吸收。

过滤网吸收的一些异味随著时间可能会再次分解散发出来，导致更多异味产生。根据使用环境的差异，尤其是在极端环境（较通常的家居使用环境远为恶劣）中使用本机时，这些异味会在比预期更短的时间内变得更为强烈。如果异味持续存在，则应更换过滤网。（请参见 C-13 页）

自来水中的矿物质附着在过滤网上时，会逐渐硬化和变白，这些矿物质会吸收室内异味，当加湿过滤网干燥时，会产生难闻的异味。（因水质和其他环境因素而异）。出现这种情况时，请保养加湿过滤网。（请参见 C-12 页）

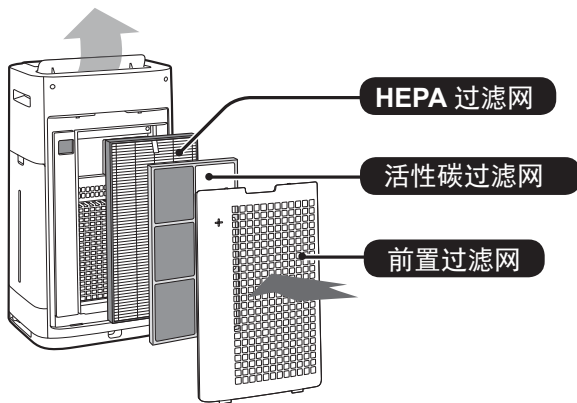

注意

- 本空气净化器用于去除空气中悬浮的灰尘和异味，而不能去除有害气体（如：香烟烟雾中的一氧化碳）。如果异味源仍然存在，空气净化器可能无法彻底去除异味。

目录

重要安全事项	C-3
• 警告	
• 注意	
• 操作的注意事项	
• 安装指南	
• 过滤网指南	
各部件名称	C-5
• 正面	
• 背部	
• 操作面板	
• 正面显示屏	
准备工作	C-7
• 安装过滤网	
操作	C-7
• 开始 / 停止	
• 雾霾模式	
• 智能模式 (KC-G60 / KC-G50)	
• 自动模式 (KC-G40)	
• 净离子群 SPOT 模式	
• 选择模式	
• 儿童安全锁	
• 加湿设置 (灌注水箱)	
• 定时开机	
• 定时关机	
• 选择显示	
• 净离子群开 / 关	
• 如何更改各种设置	
保养与清洁	C-11
• 过滤网指示灯	
• 保养护理	
• 水箱	
• 主机 / 背面板	
• 加湿过滤网和托盘	
• HEPA 过滤网 / 活性炭过滤网	
• 更换过滤网	
维修前的检查事项	C-14
规格	C-15

多谢您购买 SHARP 空气净化器。在使用空气净化器前，请详细阅读本手册。阅读后请妥善保存本手册，便于今后查阅。

重要安全事项

使用电器时，必须遵守基本安全预防措施，包括以下各方面：

警告 - 为了减少电击、火灾或受伤等危险：

- 在使用本机之前请阅读所有注意事项。
- 只能使用220-240 插座。
- 除非得到监护人或负责其安全人士的适当监督或指导，否则，本机不适合身体官能或心智能力退化者，或缺乏操作经验和知识的人士（包括儿童）使用。
儿童应受到适当的监管，以确保不会以此机器作玩具。
- 如果电源线损坏，必须由制造商或其代理、夏普公司特约维修机构或具有同等资格的人员负责更换，以免发生危险。
- 灌注水箱、进行保养、拆装及更换过滤网及长期不用时，务必拔下电源插头。否则容易造成短路，进而引发触电或火灾。
- 如果电源线或插头已经损坏，或者墙上的电源插座已松脱，请勿使用本机。
- 定期清除电源插头上的灰尘。
- 请勿将手指或异物插入吸气或吹出口。
- 当拔掉电源插头时，必须紧握插头而不要拉扯电线。否则可能导致电击或因短路引起火灾。
- 在移动主机时，脚轮请不要损坏电源线。可能会导致触电，发热或火灾。
- 注意不要损坏电源线，否则容易导致触电、过热或火灾。
- 手湿时请勿拔掉电源插头。
- 在气体设备或壁炉附近请勿使用本机。

- 只有夏普特约维修人员方可维修本空气净化器，当需要调校、修理或出现问题时，请联络就近的维修机构。
- 当使用喷雾杀虫剂时请勿使用本机，或房间内有油渣、焚香时的烟、点烟时的火苗、空气中有化学气味或浴室等可能被淋湿的地方也不要使用本机。
- 清洁空气净化器时请加以小心。具强力腐蚀性的清洁剂会损坏本机表面。
- 在搬运本机时，请先取出水箱和加湿托盘，并握持本机两侧的手柄进行操作。
- 切勿饮用加湿托盘或水箱内的水。
- 请勿使本机接触水源，否则可能导致短路或触电。
- 每日用新鲜的自来水，对水箱内的水进行更换，并定期清洗水箱和加湿托盘。（请参见C-8页，C-11页和C-12页）。当本机处于停用的状态时，应倒空水箱和加湿托盘内的水。如果有水存留于水箱和/或加湿托盘内，则可能会导致霉菌、细菌和恶臭的滋生。
在少数情况下，此类细菌可能会对健康造成损害。

注意 - 收音机或电视干扰

如果本空气净化器对收音机或电视接收造成干扰，请尝试以下列其中一项或多项措施修正干扰：

- 重新调整或重新放置接收天线。
- 增加空气净化器和收音机/电视接收器的距离。
- 将本设备的电源与接收器的电源连接到不同的插座。
- 如需协助，请联络经销商或专业的收音机/电视技术人员。

操作的注意事项

- 请勿堵塞吸气口和/或吹出口。
- 不要靠近或在热源物体上（如炉灶或暖炉式可能接触到蒸汽的场所）使用本机。

- 对本机进行操作时，请始终保持其处于直立状态。
- 在移动本机时，应握持本机两侧的手柄。当本机处于运行状态时，切勿对其进行移动。
- 如果本机放在容易损坏的地面、不平整的表面或严重卷翘的地毯上，挪动时先将其提起。
- 当推动脚轮移动设备时，请以水平方向慢慢移动。
- 挪动前先关机并拆下水箱，避免夹到手指。
- 正确安装过滤网、水箱和加湿托盘之前切勿运行本机。
- 请勿清洗和重复使用 HEPA 过滤网及活性炭过滤网。否则无法改善过滤网的使用效果，还会引发触电或操作故障。
- 仅可使用柔软的布对本机外部进行清洁。切勿使用挥发性流体和/或清洁剂。苯漆稀释剂或抛光粉会导致本机表面受损或龟裂。此外，还会引发感应器故障。
- 保养周期长短将因水的硬度和水中含有杂质的量不同而有所差别。水硬度越高，则越需要频繁地进行除垢操作。
- 请保持本机远离水源。
- 灌注水箱时，确保水箱不漏水。
- 务必彻底擦除水箱外面多余的水分。
- 切勿使用热水（40°C 或以上）、化学药剂、芳香族化合物、污水或其他具腐蚀性的物质，以免导致本机发生变形或故障。
- 仅可使用新鲜的自来水。如果使用其他水源，可能导致霉菌、真菌或细菌的滋生。
- 请勿握住水箱把手摇晃水箱。
- 如果无需更换加湿过滤网，请勿从过滤网支架上拆下加湿过滤网。
- 拆卸或清洁加湿托盘时，避免水溢出。
- 请勿拆掉浮子。
如果浮子脱落，请参见 C-13 页。

- 请勿使用清洁剂清洗加湿托盘和加湿托盘盖。否则会导致其变形、变色或开裂（漏水）。
- 清洁过程中，请勿用力擦洗背面板。

安装指南

- 请勿安装在感应器直接对住风口的地方。否则可能会影响本机正常工作。
- 避免在有可能与家俱、织物或其他物品接触的位置使用本机，否则可能无法保证吸气口或吹出口的通畅。
- 请勿安装在由于温度剧烈变化而导致本机直接暴露于冷凝环境的地方。只适宜在 0-35°C 之间的室温下使用。
- 安装必须稳固，且通风良好。
把本机放置在铺有厚地毯的地方时，可能导致本机微微震动。
请将本机放置于平整的表面，以避免水箱和/或加湿托盘漏水。
- 避免在会产生油脂或含油烟雾的场所使用本机。
否则可能会导致本机表面发生裂开，或是感应器发生故障。
- 即使本机距墙壁仅 3 cm，其集尘能力依然有效，但可能会弄脏周围墙壁和地面。请将本机与墙壁保持一定距离。
经过一段时间之后，位于吹出口正后方的墙壁可能会变脏。当长时间在同一位置使用本机时，应定期清洁周边墙壁。

过滤网指南

- 遵照说明书指示，了解正确保养和清洁过滤网的方法。
(请参见 C-11 页，C-12 页和 C-13 页)

各部件名称

正面

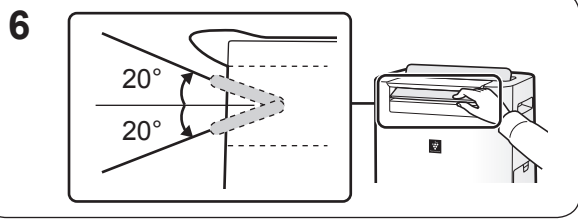
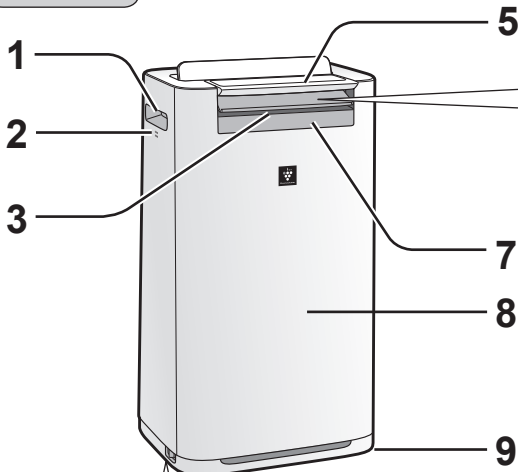

4 锁定脚轮制动器 (右侧和左侧)

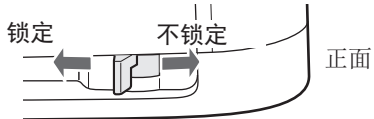

1	手柄 (2 处位置)
2	感应器 (内置) 温度/湿度/异味* (*KC-G60 / KC-G50)
3	吹出口 (正面)
4	脚轮制动器 (右侧和左侧)
5	操作面板
6	正面百叶窗 (可调节)
7	正面显示屏
8	主机
9	脚轮 (4 处位置)

背部

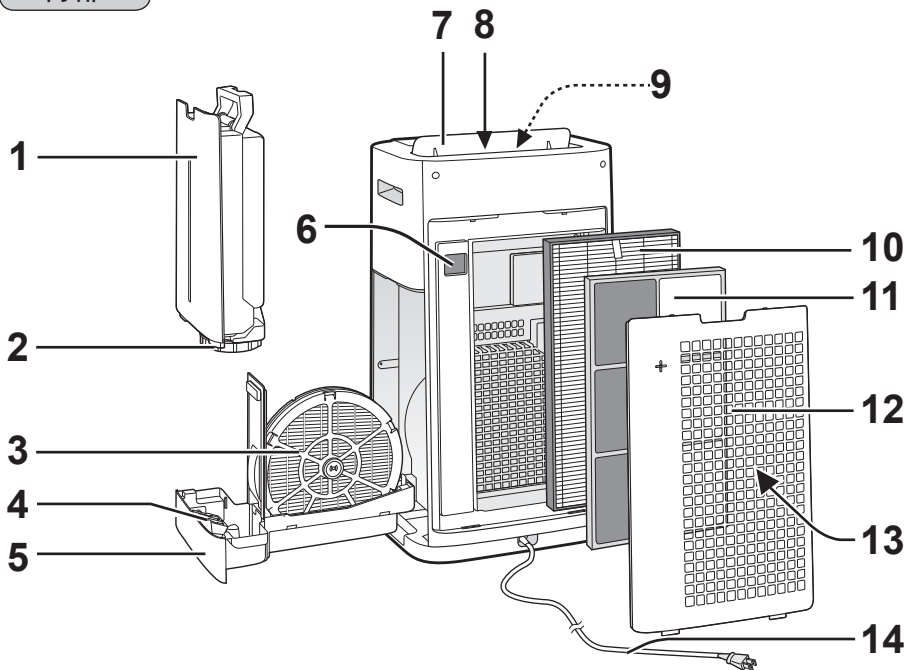

(插头形状因国家不同而异。)

探测范围

光线感应器

请勿将本机安装在如下场所。
光线感应器可能无法正常感应。

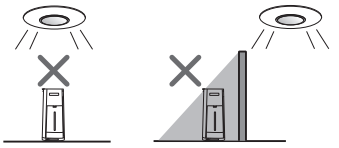

直接位于灯具
下方。

阴影处

动作感应器

(KC-G60 / KC-G50)

感应范围如下所示。

正面

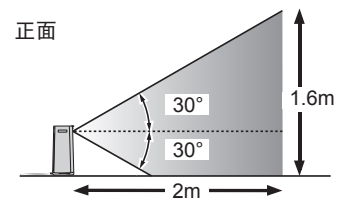

右侧和左侧

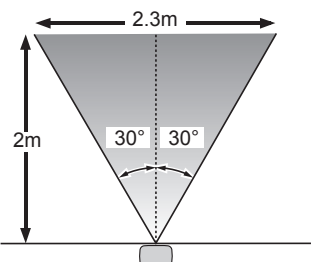

1	水箱	7	背面百叶窗
2	水箱盖	8	吹出口 (背部)
3	加湿过滤网	9	吹出口 LED (白光)
4	浮子	10	HEPA 过滤网
5	加湿托盘	11	活性炭过滤网
6	灰尘 (灵敏) 感应器 / 感应器过滤网	12	背面板 (前置过滤网)
		13	吸气口
		14	电源线 / 电源插头

操作面板

按带有 "★" 的按钮启动。

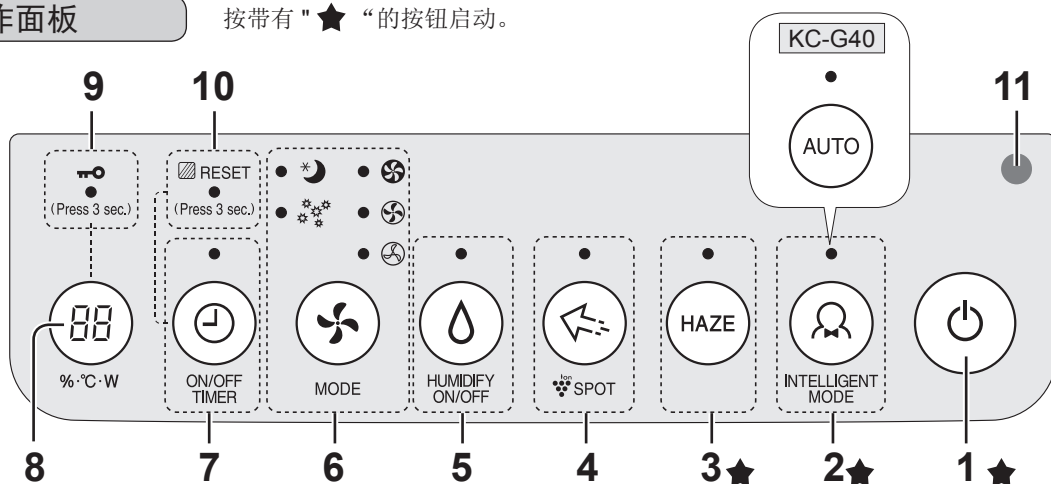

1	电源开 / 关按钮	7	开/关计时器按钮、指示灯（白色） <按 3 秒> 过滤网复位按钮
2	智能模式按钮、指示灯（白色）	8	显示选择按钮 <按 3 秒> 儿童安全锁按钮
3	雾霾按钮、指示灯（白色）	9	儿童安全锁指示灯（白色）
4	净离子群 SPOT 按钮指示灯（白色）	10	过滤网复位指示灯（橙色）
5	加湿开 / 关按钮、指示灯（白色）	11	光线感应器
6	模式按钮、指示灯（白色）		

正面显示屏

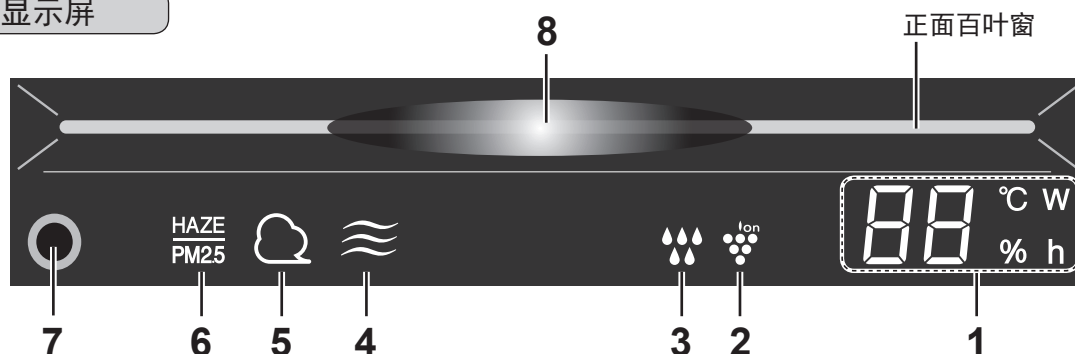

1	湿度 / 温度侦测器 显示室内大致湿度水平或温度。湿度设置无法调节。 显示湿度范围为 20% - 90%。 20% 或更低 20% ← 55% → 90% 或更高 显示温度范围为 0°C - 50°C。 -1°C 或更低 Lo °C ← 25 °C → H °C 或更高 功率侦测器 显示当前操作的功率。 计时器侦测器 显示开 / 关计时器的设置时间和剩余时间。	4	异味指示灯（白色）（KC-G60 / KC-G50） 显示异味感应器检测到异味。
	2	净离子群指示灯（蓝色）	5
3	湿度指示灯 绿色 湿度设置 开 关 湿度设置 关 红色（闪烁） 需要供水	6	雾霾 / PM2.5 指示灯（白色） 显示灰尘（灵敏）感应器检测到细微灰尘。
		7	动作感应器（KC-G60 / KC-G50）
		8	清洁度侦测器 以不同颜色分 7 级显示室内空气纯净度。 蓝色 清净 ↑↓ 红色 污浊

准备工作

在安装或调整过滤网之前拔下电源插头。



安装过滤网

1 取下背面板。

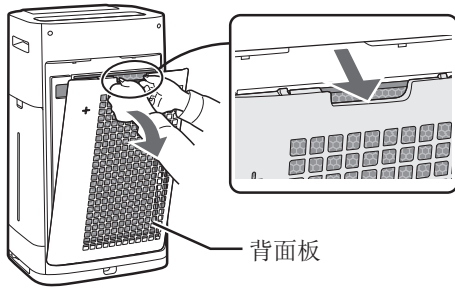

2 从每个过滤网上取下塑胶袋。

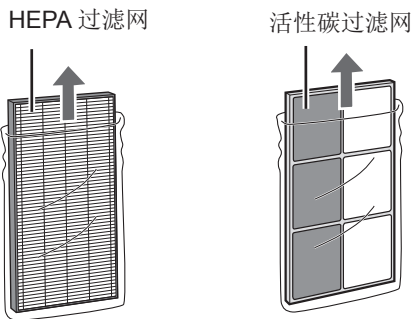

3 按照所示正确顺序安装过滤网。

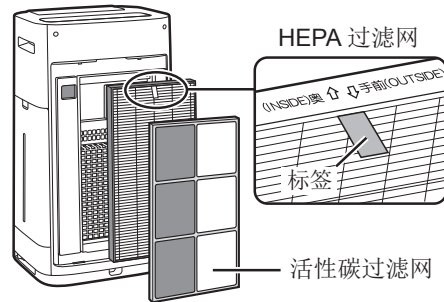

4 安装背面板。

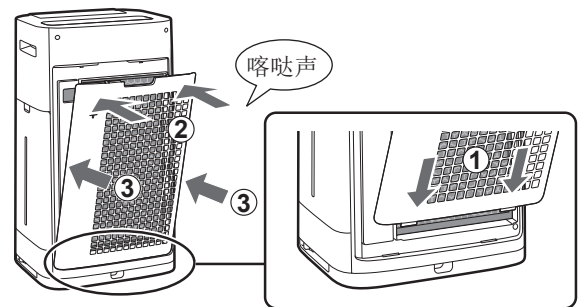

注意

• 更换过滤网时，建议记下起始使用日期。

操作

开始 / 停止

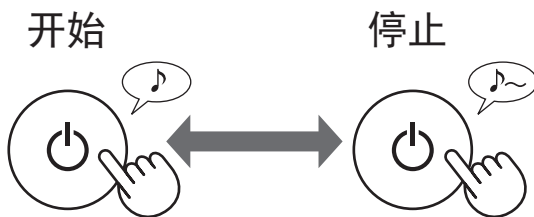

雾霾模式

风扇高速运转 60 分钟，然后以低速和高速交替运转，每种速度下运转 20 分钟。

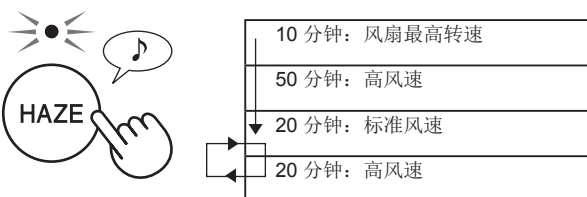

注意

• 净离子群无法“关闭”。（请参见 C-9 页）

智能模式 (KC-G60 / KC-G50)

风扇根据探测到的 7 种结果自行控制转速。（请参见 C-1 页）

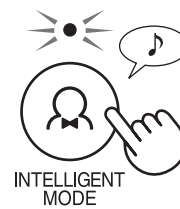

自动模式 (KC-G40)

风扇根据探测到的 5 种结果自行控制转速。（PM2.5 / 常见灰尘/温度/湿度/光线）

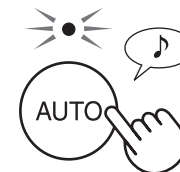

注意

• 正面显示屏、清洁度侦测器和吹出口 LED 灯根据室内亮度自动打开或关闭。（当灯光控制按钮设置为“自动 (Auto)”时。请参见 C-10 页）

净离子群 SPOT 模式

如需去除附着的气味、细菌以及来自衣物、沙发和窗帘上的其他异物，请使用该模式。

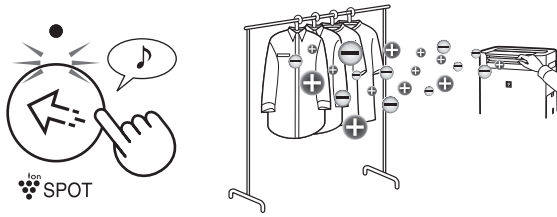

手动调节正面百叶窗。

注意

- 仅向正面方向喷出高密度净离子群。
- 吹出更强劲气流 8 小时。该操作结束时，本机返回之前的工作模式。
- 净离子群无法“关闭”。（请参见C-9页）

选择模式

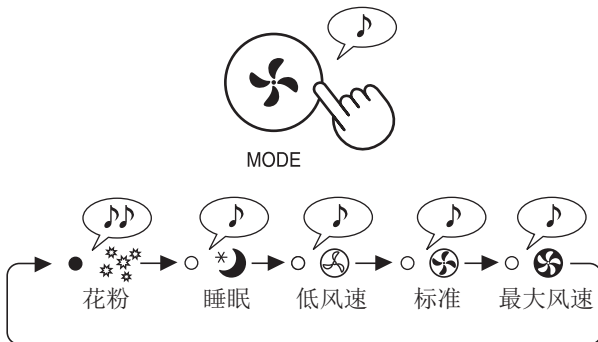

注意

睡眠

本机以超静方式运行，风扇根据空气中杂质含量自动切换风速。正面显示屏、清洁度侦测器和吹出口 LED 自动关闭。（当灯光控制按钮设置为“自动（Auto）”时。请参见 C-10 页）

花粉

灰尘感应器的灵敏度自动设置为“高”、快速探测灰尘和花粉等杂质，并强力清洁空气。

儿童安全锁

操作面板的操作锁定。

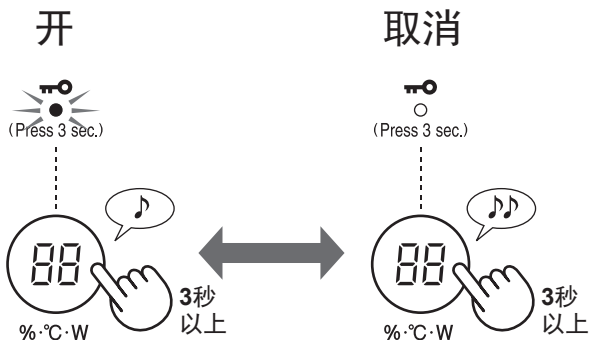

加湿设置

灌注水箱

1 取出水箱。

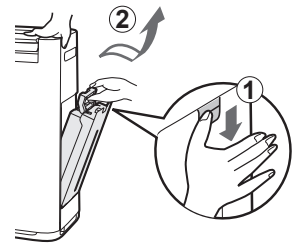

2 向水箱内注入自来水。

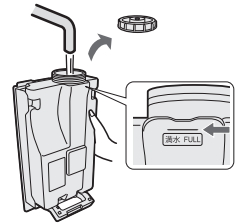

3 为防止漏水，请盖紧水箱盖。

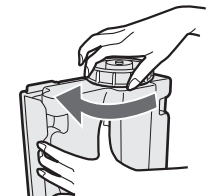

4 安装水箱。

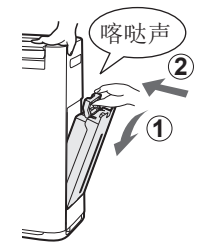

注意

加湿功能开启后，在下表中的模式下运行时，本机通过感应温度和湿度自动控制湿度。（不包括最大风速/标准/低风速模式。）

温度	湿度	
	所有模式 (不包括最大风速/标准/ 低风速/睡眠模式)	睡眠 模式
- 18 °C	65 %	65 %
18 °C - 24 °C	60 %	65 %
24 °C -	55 %	60 %

定时开机

选择您想要的时间长度。一旦运行到选定时间，该设备会自动开始。

(主机关闭)

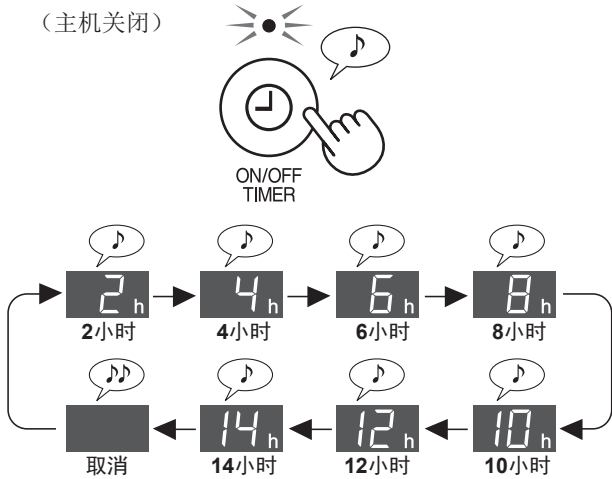

定时关机

选择您想要的时间长度。一旦运行到选定时间，该设备会自动停止。

(主机开启)

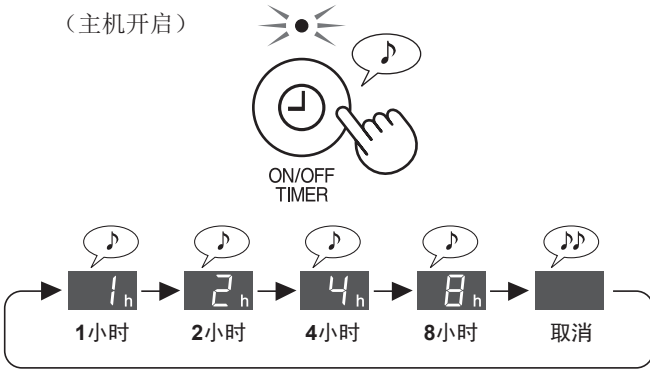

选择显示

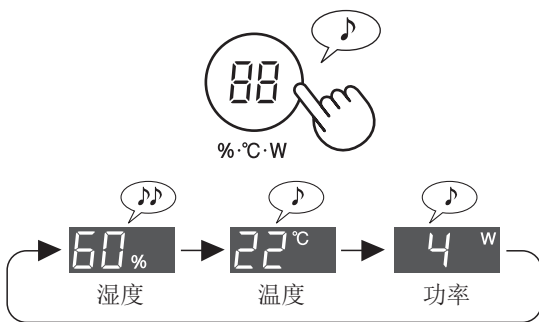

净离子群开 / 关

净离子群功能开启时，正面显示屏上的净离子群指示灯点亮。(请参见 C-6 页)

(主机开启)

开

关

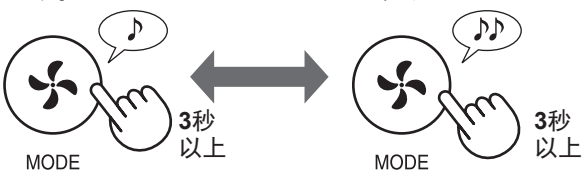

如何更改设置

可以在下一页的“设置类型”表中更改功能。

1 关闭装置电源。

2



3 从下一页的表中选择“功能编号”。

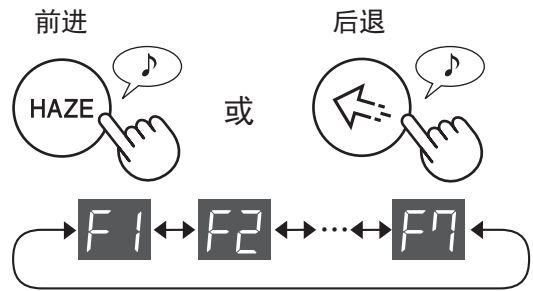

设置

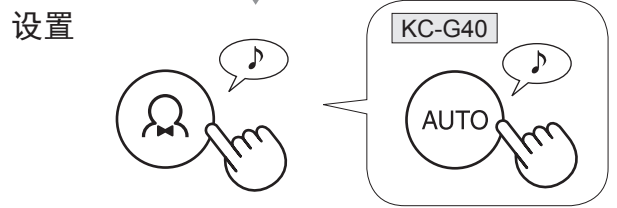

4 从下一页的表中选择“设置编号”。

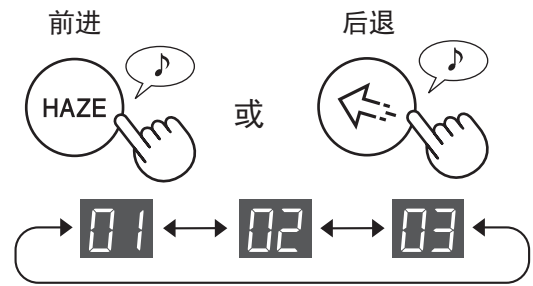

设置

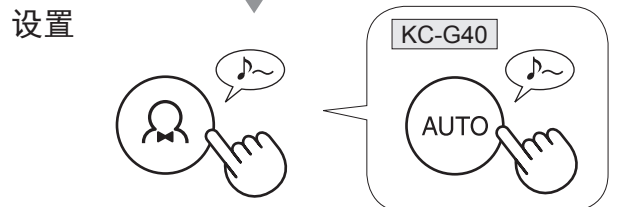

5 按电源按钮结束设置。



设置类型

功能	设置
<p>照明控制</p> <p>可以选择正面显示屏的亮度、清洁度侦测器和吹出口 LED。</p> <p>F1</p>	<p>自动（默认） 灯光根据室内亮度自动切换开或关。</p> <p>01</p> <p>室内光线亮：灯开启。 室内光线暗：灯关闭。</p> <p>较暗</p> <p>02</p> <p>关闭</p> <p>03</p> <ul style="list-style-type: none"> • 设置为“关闭”时，“较暗”指示灯在本机开始运行后点亮 3 秒，然后熄灭。 • 仅当本机需要加水时，湿度指示灯变暗闪烁。
<p>声音指示器设置</p> <p>主机可设置为水箱变空时发出哔哔声的信号。</p> <p>F2</p>	<p>01 取消（默认）</p> <p>02 开</p>
<p>自动重新启动功能</p> <p>当主机电源插头意外脱落，或是断路器在使用过程中发生故障时，在恢复供电之后，主机会自动启动并以断电前的操作模式继续操作。</p> <p>F3</p>	<p>01 取消</p> <p>02 开（默认）</p>
<p>调节感应器灵敏度（F4-F7）</p> <p>光线感应器</p> <p>F4</p> <hr/> <p>灰尘（灵敏）感应器</p> <p>F5</p> <hr/> <p>异味感应器 (KC-G60 / KC-G50)</p> <p>F6</p> <hr/> <p>动作感应器 (KC-G60 / KC-G50)</p> <p>F7</p> <p>仅动作感应器检测到房间内无人时方可设置时间。也可取消动作感应器的感应功能。</p>	<p>01 低</p> <p>02 标准（默认）</p> <p>03 高</p> <hr/> <p>01 开启（标准感应时间）（默认）</p> <p>02 开启（较长感应时间）</p> <p>03 取消</p>

保养与清洁



过滤网指示灯

指示灯将在本机使用大约 720 小时之后亮起。(30 天 × 24 小时 = 720 小时)

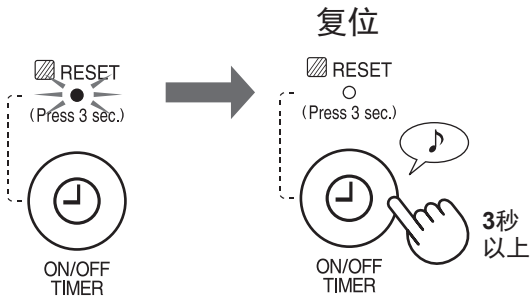

提示对以下部件进行维修。
维护工作完成之后，应对过滤网指示进行重新设置。

保养护理

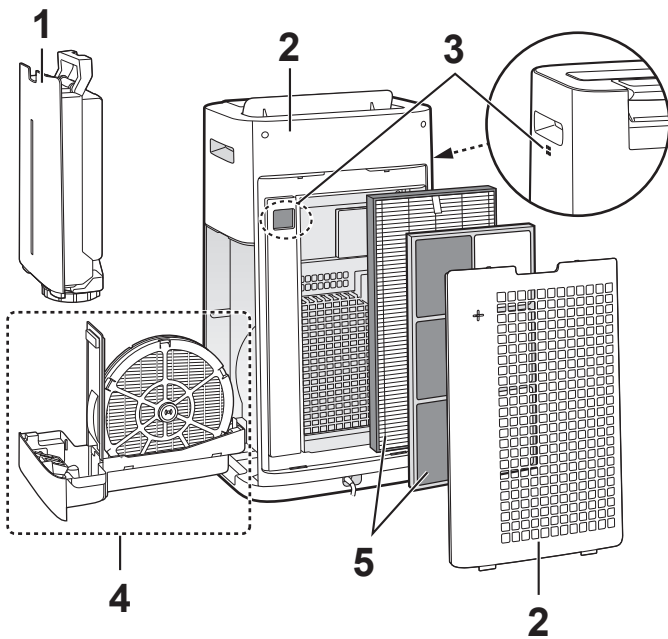

放置		参考
1	水箱	C-11 页
2	主机 / 背面板 (前置预滤器)	
3	感应器	
4	加湿过滤网 加湿托盘	C-12 页
5	HEPA 过滤网 活性炭过滤网	C-13 页

水箱

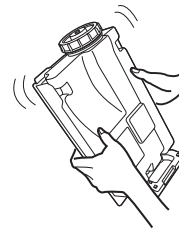

用水冲洗内部。

注意 对于难处理的污渍

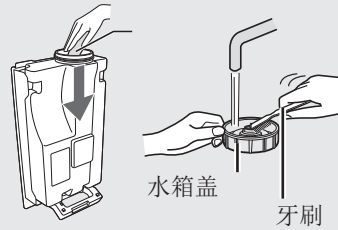

用软海绵清洗水箱内壁，用棉签或牙刷清洗水箱盖。

主机 / 背面板

使用柔软的干布擦拭。

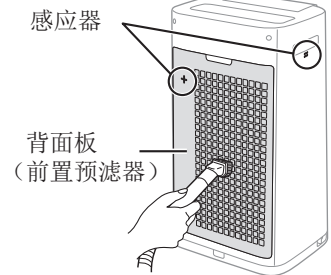

使用真空吸尘器等清洁工具小心地清除灰尘。

注意 对于难处理的污渍

背面板

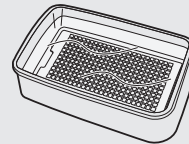

1. 在含厨房清洁剂的水中浸泡约 10 分钟。

注意

不得用力擦洗背面板。

2. 用清水清洗去除厨房清洁剂。
3. 在通风良好之处使过滤网彻底风干。如果有可能，请于室外风干。

感应器过滤网

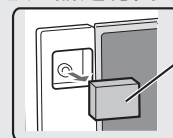

感应器过滤网

1. 卸下背面板。
2. 拆下感应器过滤网。
3. 如果感应器过滤网很脏，用水冲洗后彻底晾干。

加湿过滤网和托盘

如何拆卸加湿过滤网和托盘

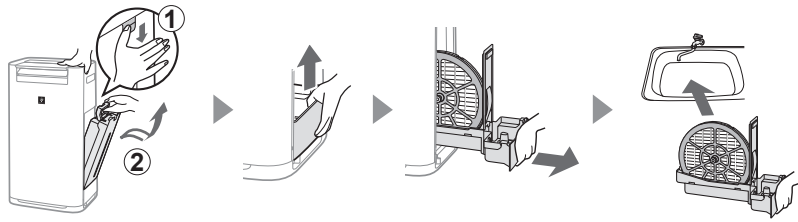

如何安装加湿过滤网和托盘

维护保养后，按照正确方式重新安装部件。

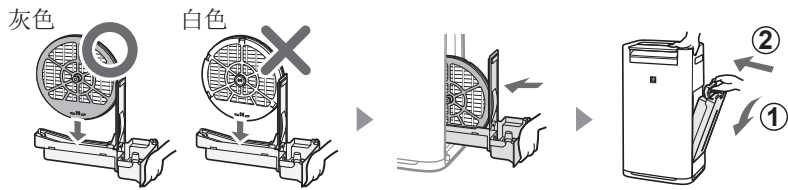

加湿过滤网

用大量水冲洗。

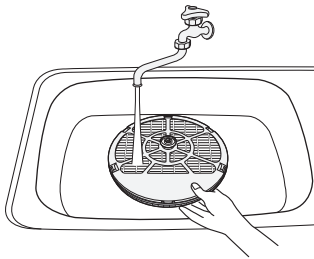

注意

如果拆下加湿过滤网轴，务必将其装回原来的位置。

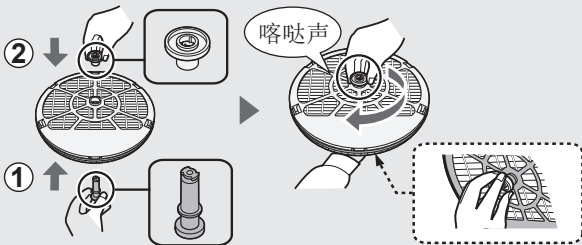

加湿托盘

1 移出加湿托盘盖。

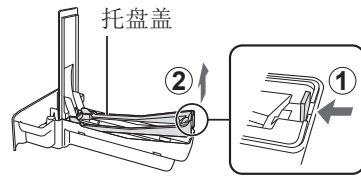

2 用大量水冲洗。

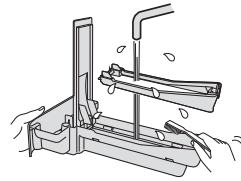

3 重新安装加湿托盘盖。

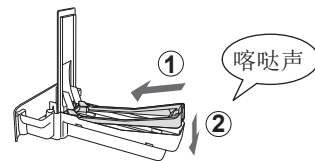

• 请勿拆掉浮子和托盘面板。如果浮子和托盘面板脱落，请参见 C-13 页。

注意 对于难处理的污渍

	厨房清洁剂 (仅加湿托盘)	柠檬酸 (部分药店有售)	不带果肉的 100% 瓶装柠檬汁
1	1. 将托盘装一半水。 2. 添加少许厨房清洁剂。	2 1/2 杯水 3 茶匙	3 杯水 1/4 杯
2	浸泡 30 分钟。	浸泡 30 分钟。	浸泡 30 分钟。 (如果使用柠檬汁作为除垢液，则需浸泡更长时间)
3	用清水冲洗掉厨房清洁剂或除垢液。		

HEPA过滤网 / 活性炭过滤网

去除 HEPA 过滤网和活性炭过滤网上的灰尘。

注意

- 请勿清洗过滤网。请勿将其置于阳光下。

HEPA过滤网

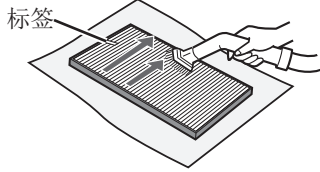

只可清洁表面贴有标签的部位。请勿清洁反面。过滤网容易破裂，务必小心，不可施加过大力量。

活性炭过滤网

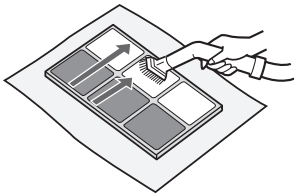

可双面清洁。如果用力过大，过滤网会损坏，因此请轻拿轻放。

过滤网吸收的一些异味随著时间可能会再次分解散发出来，导致更多异味产生。根据使用环境的差异，尤其是在极端环境（较通常的家居使用环境远为恶劣）中使用本机时，这些异味会在比预期更短的时间内变得更为强烈。此类情况下或清洁后灰尘无法去除时，请更换过滤网。

如何安装浮子和托盘面板

托盘面板

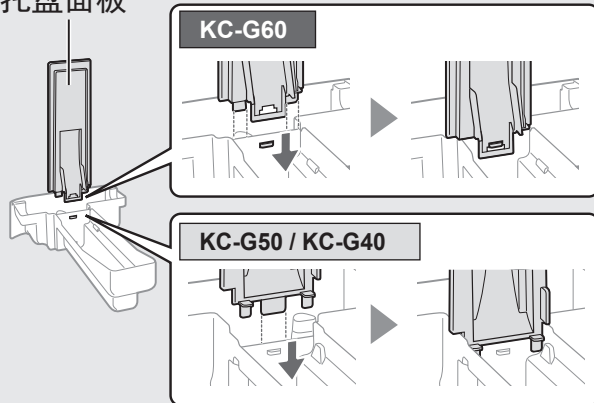

浮子

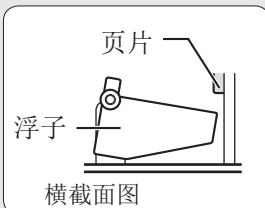

1. 将浮子插入至此页片下。

3. 将页片插入至浮子另一侧的孔内。

2. 将页片插入至浮子另一侧的孔内。

更换过滤网

更换时期

过滤网的使用寿命会因室内环境因素、使用方法和本机放置的位置不同而有所差别。如果灰尘或异味持续存在，则应更换过滤网。

HEPA 过滤网和活性炭过滤网的使用寿命及更换周期以以下条件为基准。

如果每天在室内净化 5 根香烟所散发出来的烟雾，则本机的集尘和除臭功效效果较新过滤网减半。

若在烟雾环境比日常居家更严重（雾霾等）的环境下使用本产品，请勤换过滤网。

- HEPA 过滤网 打开后最多可使用10年
- 活性炭过滤网 打开后最多可使用10年
- 加湿过滤网 打开后最多可使用10年

更换用的过滤网型号

如需购买用于更换的过滤网，请与夏普公司服务中心联系。

更换用的过滤网型号	KC-G60	KC-G50	KC-G40
HEPA过滤网 (1件)	FZ-D60HFE	FZ-D40HFE	FZ-D40HFE
活性炭过滤网 (1件)	FZ-G60DFE	FZ-G40DFE	FZ-G40DFE
加湿过滤网 (1件)	FZ-G60MFE	FZ-G60MFE	FZ-G60MFE

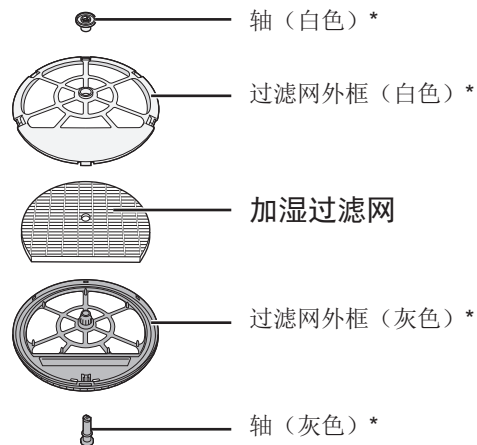

* 请勿处理这些部件。

弃置过滤网

请按照当地法律规定来处理已使用的过滤网。

HEPA 过滤网材料:

- 过滤网: 聚丙烯
- 外框: 聚酯

活性炭过滤网材料:

- 过滤网: 纸
- 支架: ABS 树脂

加湿过滤网材料:

- 过滤网: 人造纤维、聚酯

维修前的检查事项

联系维修之前，请检查下面的故障排除表，确保该问题不属于装置故障。

症状	补救措施（并非故障）
不能去除异味和烟雾。	<ul style="list-style-type: none"> 如果过滤网已很脏，请清洁或更换。（请参见 C-13 页）
即使空气不干净，清洁度侦测器指示灯也是蓝色。	<ul style="list-style-type: none"> 当本机刚刚接通电源时，吹出的空气可能会有杂质。拔掉电源插头，等待一分钟，然后再次接通本机电源。
即使空气干净，清洁度侦测器指示灯也是红色。	<ul style="list-style-type: none"> 灰尘（灵敏）感应器开口脏污或堵塞时影响感应器的使用。轻轻清洁感应器过滤网或背面板。（请参见 C-11 页）
主机发出喀嚓/滴答声。	<ul style="list-style-type: none"> 当本机产生净离子群时，可能会听到喀嚓声或滴答声。
排放的空气有异味。	<ul style="list-style-type: none"> 检查过滤网是否已很脏。 清洁或更换过滤网。（请参见 C-11 页，C-12 页，C-13 页） 仅可使用新鲜的自来水。如果使用其他水源，可能导致霉菌、真菌或细菌的滋生。
空气中有烟草烟雾时，本机不运行。	<ul style="list-style-type: none"> 确保本机安装在感应器能探测到烟草烟雾的地方。 检查并确认灰尘（灵敏）感应器开口是否堵住或阻塞。如果开口堵住或阻塞，清洁感应器过滤网或背面板。（请参见 C-11 页）
过滤网复位指示灯点亮。	<ul style="list-style-type: none"> 进行维护保养或更换过滤网后，请将电源线连接到电源插座上，然后按下过滤网复位按钮。（请参见 C-11 页）
前面显示屏关闭。	<ul style="list-style-type: none"> 照明控制设为“自动”时，当室内光线较暗时，照明灯自动关闭。此外，当照明控制设置为“关闭”时，照明灯始终关闭。如果不想关闭照明灯，将照明控制设置为“较暗”。（请参见 C-9 页，C-10 页）
水箱无水时，正面显示屏上的湿度指示灯不会点亮。	<ul style="list-style-type: none"> 室内湿度达到合适水平，停止加湿。 检查聚苯乙烯泡沫外框上是否有杂质。清洁加湿托盘。确保本机放置在水平面上。（请参见 C-12 页）
水箱中的水量没有减少或减少太慢。	<ul style="list-style-type: none"> 请检查加湿托盘和水箱是否已经正确安装。请检查加湿过滤网。（请参见 C-12 页） 请检查过滤网，当过滤网非常肮脏时，请更换过滤网。（请参见 C-13 页）
清洁度侦测器的指示灯频繁改变颜色。	<ul style="list-style-type: none"> 当灰尘（灵敏）感应器和异味感应器*检测到杂质时，清洁度侦测器自动改变颜色。如果无需频繁改变颜色，可以更改感应器的灵敏度。（请参见 C-9 页，C-10 页）（*KC-G60 / KC-G50）
本机的湿度侦测器与室内另一个湿度计的测量结果有所差异。	<ul style="list-style-type: none"> 室内湿度水平不一致。 感应器测量参数不同。 如果侦测器显示功率或温度，按显示选择按钮切换显示内容。（请参见 C-9 页）
本机的雾霾 / PM2.5 指示灯与天气预报或其他本地 PM2.5 数据不匹配。	<ul style="list-style-type: none"> 室外和室内以及家庭环境（附近交通量、家中楼层的层数等）可能导致读数与本地 PM2.5 数据不同。

错误显示 如果错误再次出现，请联系夏普维修中心。

数字指示	补救措施
E2	请检查加湿过滤网和加湿托盘是否正确安装然后再次打开电源。
C1 C4 C6 C9	拔掉本机电源插头，等待一分钟，然后再次插上本机电源插头。

规格

型号	KC-G60			KC-G50			KC-G40			
电源	220-240 V 50-60 Hz									
风量调整	最大	标准	低	最大	标准	低	最大	标准	低	
空气清净	风量 (m ³ /小时)	408	240	72	306	180	60	240	120	60
	额定功率 (W)	82	38	5.0	58	26	5.0	33	12	5.0
	噪音 (dBA)	55	40	7.0	52	47	19	46	41	19
空气加湿 空气清净	风量 (m ³ /小时)	342	240	72	240	120	60	210	120	60
	额定功率 (W)	55	40	7.0	32	28	7.0	22	14	7.0
	噪音 (dBA)	53	48	25	46	40	20	43	40	20
	加湿 (mL/小时)*1	630	470	200	450	300	150	400	300	150
推荐安放房间大小 (m ²)*2	- 50			- 38			- 29			
高浓度净离子群浓度适用面积 (m ²)*3	- 35			- 28			- 21			
水箱容量 (L)	3.0			2.5			2.5			
感应器	灰尘 (灵敏) / 异味/光线 / 温度和湿度/动作						灰尘 (灵敏) / 光线 / 温度和湿度			
电源线长度 (m)	2.0									
外形尺寸 (mm)	370 (W) × 293 (D) × 660 (H)			345 (W) × 262 (D) × 631 (H)			345 (W) × 262 (D) × 631 (H)			
重量 (kg)	10.4			8.9			8.9			

- *1 • 空气加湿量随着室内和室外温度及湿度的变化而有所不同。
空气加湿量随着温度上升或湿度下降而增强。
空气加湿量随着温度降低或湿度上升而减弱。
• 计量条件：20℃，相对湿度30%（JEM1426标准）
- *2 • 推荐房间大小：在最大风速下运行本机时最适合的房间大小。（空气清净或空气加湿清净）
• 推荐房间大小区域是指在30分钟内能去除固定数量的灰尘粒子的区域。
- *3 • 房间大小为：当本机被放置于靠近窗户的位置、并以标注运行能力进行工作时，在房屋中央（距离地面大约1.2米的高度）能够检测到每立方厘米空气中含有大约7000个离子。

关于备用耗电量

当电源插头插入插座时，本机在备用状态下的耗电量为0.6瓦。
为节省用电，在不使用本机时请拔掉电源接线。

SHARP

SHARP CORPORATION

OSAKA, JAPAN

FACTORY
USE ONLY



Printed in China

TINS-B016KKRZ 17E — ①