

SHARP®

MODEL

HT-C21DS1

SOUND BAR HOME THEATER SYSTEM

OPERATION MANUAL

Thank you for purchasing this SHARP product. To obtain the best performance from this product, please read this manual carefully. It will guide you in operating your SHARP product.

HT-C21DS1 consisting of HT-C21DS1 (Sound Bar Home Theater System) and CP-SW21D1 (Active Subwoofer System).



 **Dolby Atmos**

COMPATIBLE WITH

 **Dolby Vision**



HDMI®
HIGH-DEFINITION MULTIMEDIA INTERFACE

eARC/ARC

 **Bluetooth®**



Notes:

- This product is designed for HDMI ARC (Please set Dolby Audio or PCM output for TV).
- This product's Bluetooth is designed for smart phone or other external device only. For TV connectivity, HDMI is highly recommended for optimal TV performance.







TINSEA570AWZZ

SHARP CORPORATION

22D R AS ①

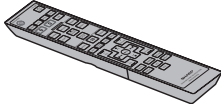
Accessories

The following accessories are included.

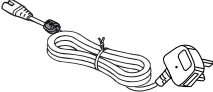
 <p>Remote control x 1</p>	 <p>"AAA" size battery (UM/SUM4, R3, HP-16 or similar) x 2</p>	 <p>Subwoofer Stand x 2</p>
 <p>AC power lead x 1 (for subwoofer)</p>	<p>For Middle East countries</p>  <p>AC power lead x 1 (for subwoofer)</p>	

Special notes

The terms HDMI, HDMI High-Definition Multimedia Interface, and the HDMI Logo are trademarks or registered trademarks of HDMI Licensing Administrator Inc.

Dolby, Dolby Vision, Dolby Atmos, and the double-D symbol are registered trademarks of Dolby Laboratories Licensing Corporation. Manufactured under license from Dolby Laboratories. Confidential unpublished works. Copyright © 2012–2020 Dolby Laboratories. All rights reserved.

The *Bluetooth*® word mark and logos are registered trademarks owned by *Bluetooth* SIG, Inc. and any use of such marks by SHARP is under license. Other trademarks and trade names are those of their respective owners.

The product with the Hi-Res Audio logo is conformed to Hi-Res Audio standard defined by Japan Audio Society. The logo is used under license from Japan Audio Society.

Supply of this product does not convey a license nor imply any right to distribute content created with this product in revenue-generating broadcast systems (terrestrial, satellite, cable and/or other distribution channels), revenue-generating streaming applications (via Internet, intranets and/or other networks), other revenue-generating content distribution systems (pay-audio or audio-on-demand applications and the like) or on revenue-generating physical media (compact discs, digital versatile discs, semiconductor chips, hard drives, memory cards and the like). An independent license for such use is required. For details, please visit <http://mp3licensing.com>

MPEG Layer-3 audio coding technology licensed from Fraunhofer IIS and Thomson.

Warning:

- When the HT-C21DS1 button is set at STANDBY position, mains voltage is still present inside the unit. The unit may be brought into operation by the remote control.
- This unit contains no user serviceable parts. Never remove covers unless qualified to do so. This unit contains dangerous voltages, always remove main plug from the socket before any service operation and when not in use for a long period.
- To prevent fire or shock hazard, do not expose this appliance to dripping or splashing. No objects filled with liquids, such as vases, shall be placed on the apparatus.
-  This equipment is a Class II or double insulated electrical appliance. It has been designed in such a way that it does not require a safety connection to electrical earth.

Precautions

■ General

- Please ensure that the equipment is positioned in a well ventilated area and ensure that there is a free space along the sides, top and back of the equipment as below.

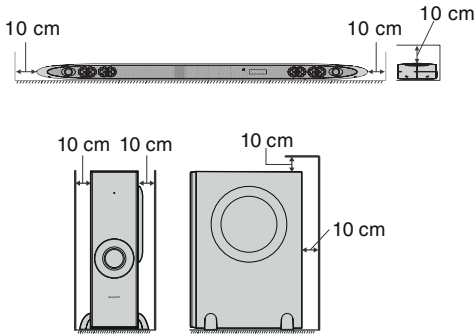

- The ventilation should not be impeded by covering the ventilation openings with items, such as newspapers, tablecloths, curtains, etc.
- No naked flame sources, such as lighted candles, should be placed on the apparatus.
- Attention should be drawn to the environmental aspects of battery disposal.
- Use the unit on a firm, level surface free from vibration.
- Keep the unit away from direct sunlight, strong magnetic fields, excessive dust, humidity and electronic/ electrical equipment (home computers, facsimiles, etc.) which generate electrical noise.
- Do not place anything on top of the unit.
- Do not expose the unit to moisture, to temperatures higher than 60°C (140°F) or to extremely low temperatures.

- If the unit does not work properly, unplug and plug it in again. Then turn it on.
- In case of an electrical storm, unplug the unit for safety.
- Hold the AC power plug by the head when removing it from the wall socket, as pulling the lead can damage internal wires.
- The AC power plug is used as a disconnect device and shall always remain readily operable.
- **Do not remove the outer cover, as this may result in electric shock. Refer internal service to your local SHARP service facility.**
- This unit should only be used within the range of 5°C ~ 35°C (41°F ~ 95°F).
- SHARP is not responsible for damage due to improper use. Refer all servicing to a SHARP authorised service centre.

Warnings:

- The voltage used must be the same as that specified on this unit. Using a higher voltage is dangerous and may result in a fire or other type of accident causing damage. SHARP will not be held responsible for any damage resulting from such usage.
- In case of repairing, please bring the entire system set to the service centre.

■ Volume control

The sound level at a given volume setting depends on speaker efficiency, location and various other factors. It is advisable to avoid exposure to high volume levels, which occurs while turning the unit on with the volume control setting up high, or while continually listening at high volumes.

Controls and indicators

■ Sound Bar

Front view

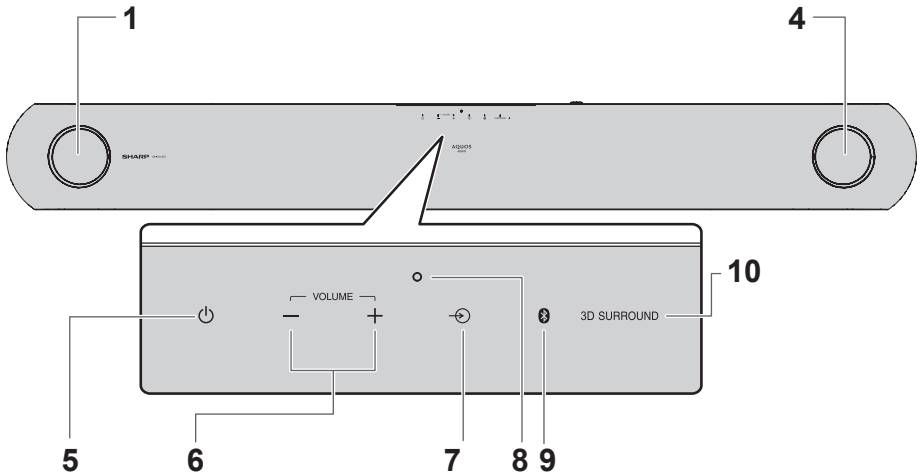

- | | | | |
|---|------------------------|---|------------------------------------|
| 1 | Left Channel Speakers | 5 | Volume Down/Up Buttons |
| 2 | Remote Sensor | 6 | Input Button |
| 3 | Display | 7 | On/Standby/Pairing/Input indicator |
| 4 | Right Channel Speakers | 8 | Pairing Button |
| 5 | On/Standby Button | 9 | 3D Surround Button |

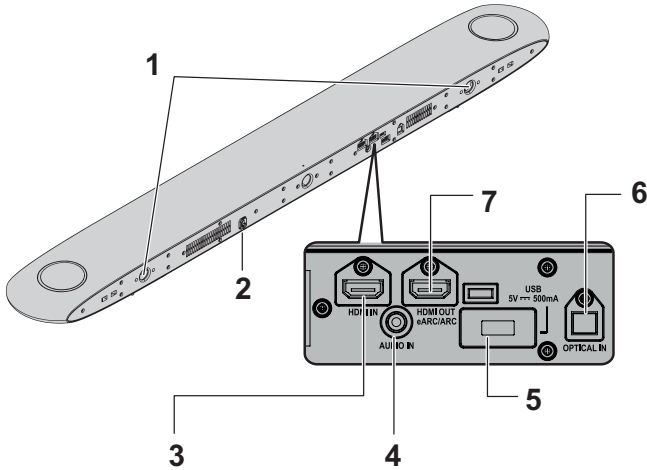

- 1 Bass Reflect Duct
- 2 AC Power Lead
- 3 HDMI IN Terminal
- 4 Audio IN Terminal

- 5 USB Terminal
- 6 Optical IN Terminal
- 7 HDMI OUT (eARC/ ARC) Terminal

■ Subwoofer

Front view

Rear view

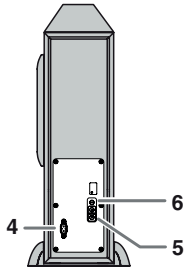
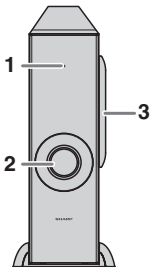

- 1 Power/Pairing Indicator
- 2 Bass Reflect Duct
- 3 Woofer
- 4 AC Power Socket
- 5 Service A/B Buttons
- 6 SW LINK (Subwoofer Link) button

■ Remote Control

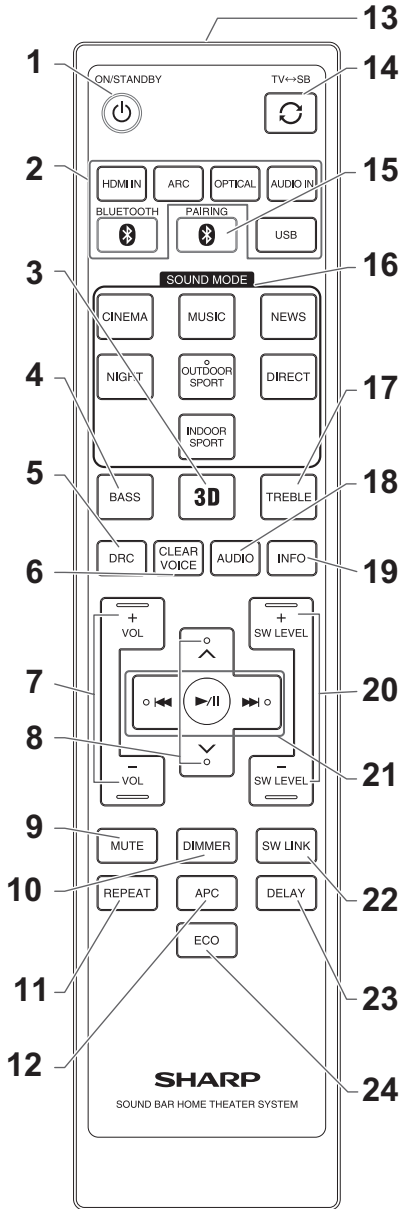

- 1 ON/STANDBY Button
- 2 INPUT
 - HDMI IN Button
 - ARC Button
 - OPTICAL Button
 - AUDIO IN Button
- 3 3D Surround Button
- 4 Bass Button
- 5 DRC Button
- 6 Clear Voice Button
- 7 Volume Up/Down Buttons
- 8 Up/Down Buttons
- 9 Mute Button
- 10 Dimmer Button
- 11 Repeat Button
- 12 APC Button
- 13 Remote Control Transmitter
- 14 TV ↔ SB Speaker Select Button
- 15 Bluetooth Pairing Button
- 16 Sound Mode
 - CINEMA Button
 - MUSIC Button
 - NEWS Button
 - NIGHT Button
 - OUTDOOR SPORT Button
 - DIRECT Button
 - INDOOR SPORT Button
- 17 Treble Button
- 18 Audio Button
- 19 Info Button
- 20 SW (Subwoofer) Level Up/Down Buttons
- 21 Next/Previous Buttons
- 22 SW (Subwoofer) Link Button
- 23 Delay Button
- 24 Eco Button

Placing the system

Installation image:

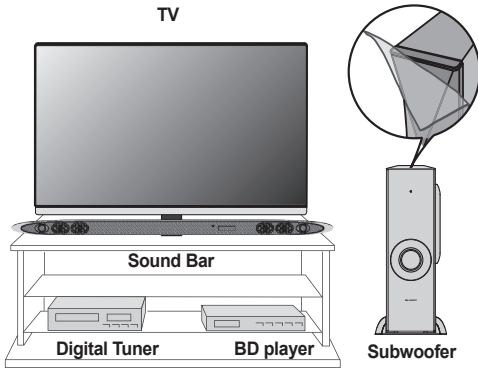

Notes:

- The front panel of the sound bar is not removable.
- The maximum transmission distance of the wireless signal between the subwoofer and sound bar is about 10 metres (32 feet), but may vary depending on your operating environment. If a steel-concrete or metallic wall is between the subwoofer and the sound bar, the system may not operate at all, because the wireless signal cannot penetrate metal.

Caution:

- Do not change the installation direction when the sound bar is turned on.
- Do not stand or sit on the sound bar and subwoofer as you may be injured.
- Do not allow any objects to fall into or to be placed in the bass reflex duct.

Place the system as shown. Remove the protective film covering the subwoofer before turn on the system.

■ Placing the subwoofer stand

Place the stand as shown.

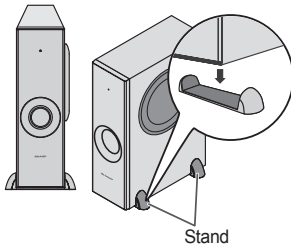

Falling prevention

Safety wires (not supplied) are useful to prevent the sound bar from falling off.

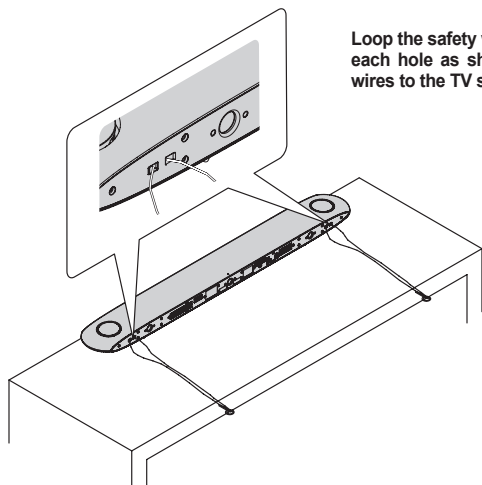

Loop the safety wires (not supplied) into each hole as shown and tie the safety wires to the TV stand.

System connections

■ HDMI Connection

Caution:

Turn off all other equipment before making this connection.

1. Method 1

This connection is for HDMI TV with eARC/ARC.

- eARC : Enhanced Audio Return Channel
- ARC : Audio Return Channel

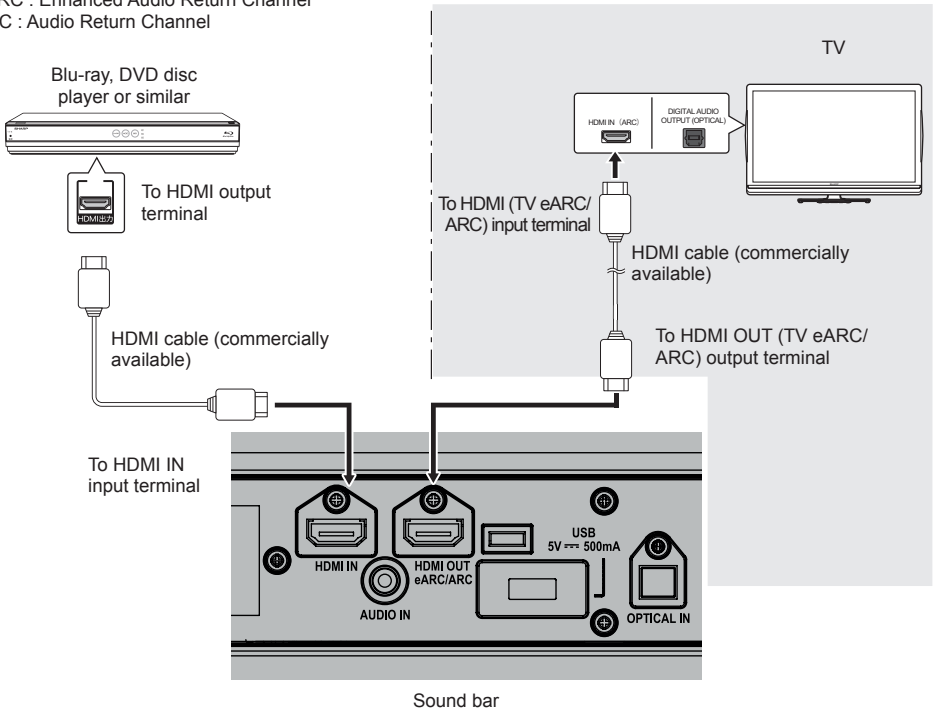

- Connect to an eARC/ARC compatible AQUOS with an HDMI cable. To listen to the sound, connect to the HDMI input terminal compatible with eARC/ARC.
- Some model may not be able to perform above operation. For detail, refer to the operation manual of the respective component.

System connections (continued)

2. Method 2

This connection is for HDMI TV without eARC/ARC.

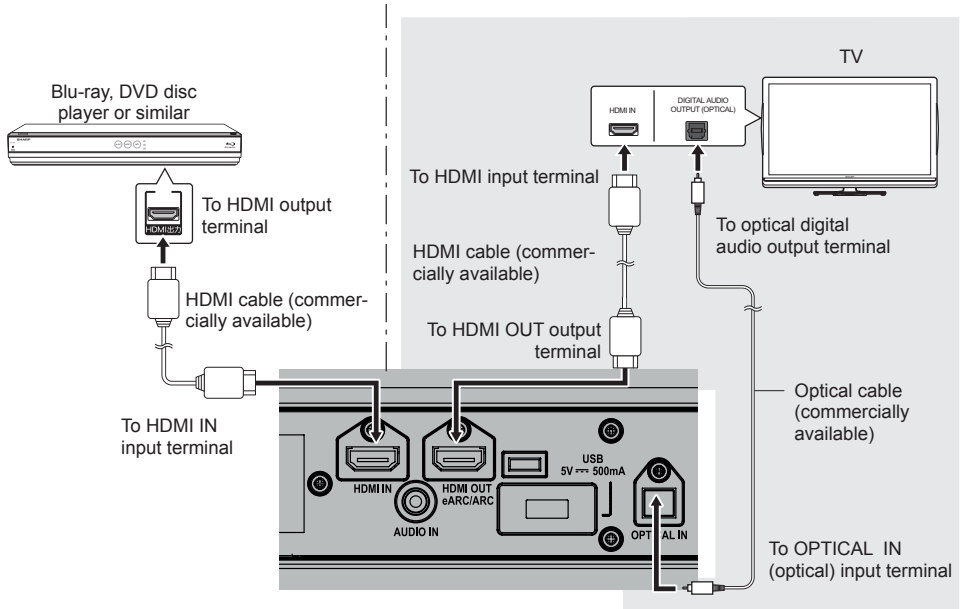

To select HDMI TV with eARC/ARC or HDMI TV without eARC/ARC function (Source):

Press INPUT \odot button repeatedly on the sound bar or HDMI IN or ARC button on the remote control to select "HDMI IN" or "TV ARC".

Notes:

- This sound bar supports HDMI which enables eARC/ARC.
- To enable ARC make sure to use High Speed (category 2 with Ethernet) HDMI™ cable (with ARC).
- This eARC/ARC feature requires TV that supports eARC/ARC. Refer the operation manual of the TV to determine which terminal supports eARC/ARC.
- To listen to the sound from a non-ARC-compatible TV, connect the audio output from TV to this system's. (refer figure above)
- This sound bar can be operated (power on/off or volume up/down) via a TV or similar component which supports HDMI CEC (Consumer Electronics Control). If this does not work, it does not mean this system is faulty. Refer to the operation manual of the respective component on how to activate the CEC.

Example: Go to the Menu of the component to search and enable the CEC. Different brands may have different naming for the CEC.

For SHARP LCD TV, it is named as AQUOS LINK.

- **The system will automatically power off if TV or similar component which supports HDMI CEC, is turned off.**
- CEC is not available during Low power consumption mode (Eco mode on).
- **To listen to the sound from this system, you will need to press TV \leftrightarrow SB button (refer page 15) or adjust the speaker output settings within the TV menu. For details, refer to the operation manual of the TV.**
- **If you are unable to select external speaker setting from the TV menu (E.g. For SHARP LCD TV, it is named as AQUOS AUDIO SP), turn the CEC OFF and ON again.**
- To enjoy 3D images or 4K content, this system must be connected to a 3D or 4K-compatible TV and components (3D BD player, etc.) via High Speed HDMI cables. Put on the 3D glasses (for 3D-compatible TV and components), otherwise 3D images or 4K content may not be viewed properly.

System connections (continued)

■ Connecting a TV, or DVD player, etc.

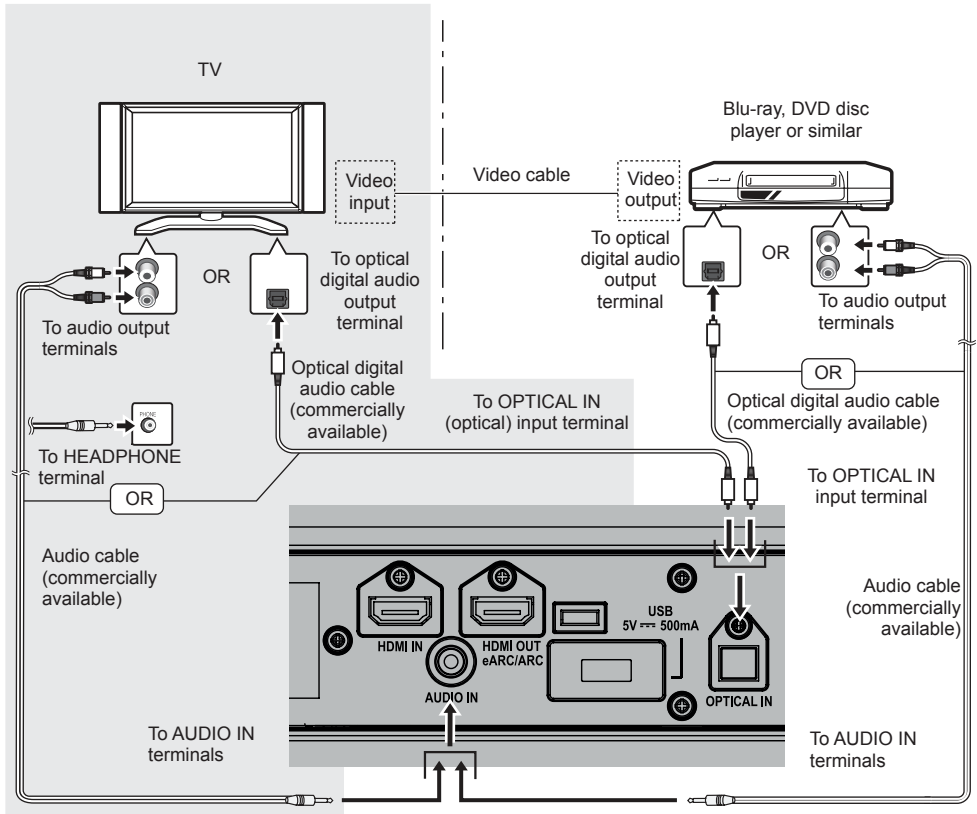

Press the INPUT  button repeatedly on the sound bar or OPTICAL or AUDIO IN button on remote control to select "OPTICAL" or "AUDIO IN".

Caution:

- When connected to the headphone terminal of a monaural TV, sound may not be output from both left or right front speaker.

■ Comments on the HDMI cable

- If a protective cap is attached to the connector, please make sure to remove the cap before connecting.
- Please purchase a commercially available HDMI cable.
- When using commercially available HDMI cable, please purchase the HDMI cable compatible with Ethernet standard, high speed type with HDMI logo, of a length 2 m or less to prevent unstable operation and deterioration of image quality.
- Plug the HDMI connector all the way into the socket and do not pull it. If the connector comes out of the terminal, the unit will not operate properly. Also, when it is not tightly inserted, the image may be blurred or noise may be generated.

■ Comments on the optical audio cable

- If a protective cap is attached to the connector, please make sure to remove the cap before connecting.
- The optical digital audio cable (commercially available) can be damaged if it is bent too strongly. Please do not bend it below 60 mm diameter.

System connections (continued)

Make sure to unplug the AC power lead before making any connections.

Sound Bar

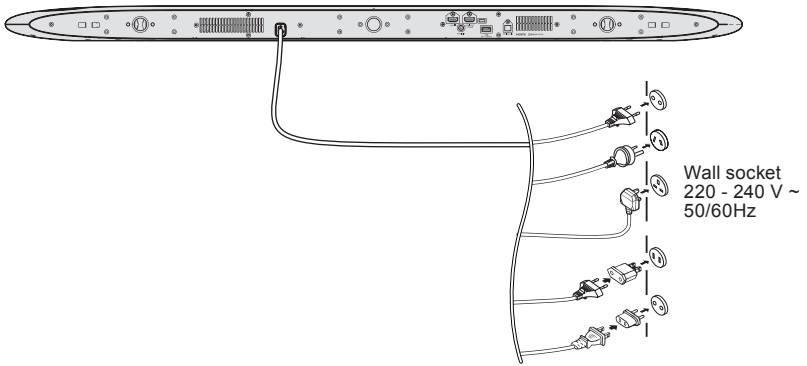

Subwoofer

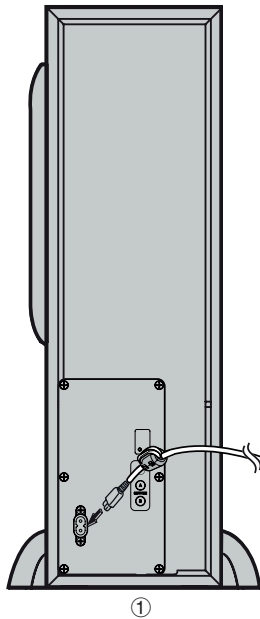

- 1 Plug the AC power lead into the DC input socket on the subwoofer.
- 2 Plug the AC power lead into an wall socket. The Power/Pairing indicator turns RED.

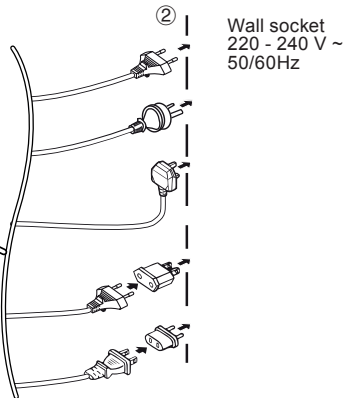

Remote control

Battery installation

- 1 Open the battery cover.
- 2 Insert the batteries according to the terminal indicated in the battery compartment. When inserting or removing the batteries, push them towards the (-) battery terminals.
- 3 Close the cover.

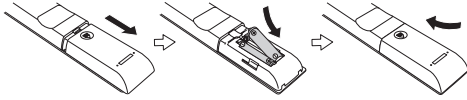

Caution:

- Replace all old batteries with new ones at the same time.
- Do not mix old and new batteries.
- Remove the batteries if the unit will not be used for a long period of time. This will prevent potential damage due to battery leakage.
- Do not use rechargeable batteries (nickel-cadmium battery, etc.).
- Installing the batteries incorrectly may cause the unit to malfunction.
- Batteries (battery pack or batteries installed) shall not be exposed to excessive heat such as sunshine, fire or the like.

Notes concerning use:

- Replace the batteries if the operating distance is reduced or if the operation becomes erratic. Purchase 2 "AAA" size batteries (UM/SUM4, R3, HP-16 or similar).
- Periodically clean the transmitter on the remote control and the sensor on the unit with a soft cloth.
- Exposing the sensor on the unit to strong light may interfere with operation. Change the lighting or the direction of the unit.
- Keep the remote control away from moisture, heat, shock, and vibrations.

Test of the remote control

The remote control can be used within the range shown below:

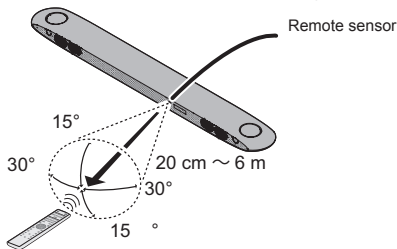

General control

Make sure to enable the HDMI CEC when making HDMI connection. For details, refer to the operation manual of the TV.

To turn the power on

Press the \odot / ON/STANDBY button on the sound bar or remote control.

- On sound bar: The power turns on and the indicator lights off. "WELCOME" appears on the display.
- On Subwoofer: The Power/Subwoofer link indicator turns blue.

Notes:

The system will automatically power on if TV or similar component which supports HDMI CEC, is turned on.

To set the sound bar to standby mode:

Press the \odot / ON/STANDBY button on the sound bar or remote control. "GOOD BYE" appears on the display.

Notes:

- A slight audio delay after TV is turned ON does not mean that the system is faulty. This is normal.
- "AQUOS speaker is enabled" message will be displayed if SHARP LCD TV does not detect HT-C21DS1 during power on. However the message "AQUOS audio with AQUOS LINK is enabled" will be displayed soon as HT-C21DS1 is detected. These messages may vary depending on TV model.

Eco mode (remote control)

- The first time the unit is plugged in it will enter standby mode (Eco mode off). Sound bar indicator turns red.
- To cancel the standby mode, perform the following procedure.

During standby mode, press and hold the ECO button on the remote control.

- Sound bar indication light turned off.

Notes:

- When turning on the power from Eco mode, it may take some time until the power is turned on.
- AQUOS LINK function does not work during Eco mode.

Caution:

- During Eco mode, very small power is consumed when the power cord is connected.

To cancel the Eco mode:

When the sound bar is turned off, press and hold the ECO button on the remote.

- Sound bar indication lights up in red.

General control (continued)

■ APC (Auto Power Off Control) (remote control)

This sound bar can be set to turn off automatically if no signal or connection is detected. (During Optical and Bluetooth function only).

1. Press the APC button repeatedly to select the time.

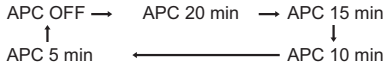

2. The sound bar will enter the power standby mode automatically if no signal is detected after the preset time has elapsed.

Notes:

- The system will automatically power off if TV or similar component which supports AQUOS LINK, is set to turn off.

■ Pairing with the Subwoofer

The sound bar and subwoofer will link automatically (wirelessly) when turned on as it is already pre-linked at the factory.

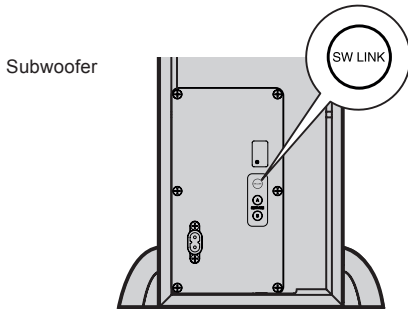

If the link cannot be established, please set the connection by the following method.

1. Press the ON/STANDBY button on the sound bar or remote control to enter standby mode.
 2. Press and hold the SW LINK button on remote control the "SW LINK" appears on the display.
 3. Within 2 minutes, plug in the power supply for subwoofer and then press and hold the SW LINK button at back of the subwoofer for more than 5 seconds.
- During pairing process:
On sound bar: "SW LINK" will blink.
On subwoofer: indicator will blink in blue.
 - When pairing is successful:
On sound bar: "SW LINK" disappears.
On subwoofer: indicator turns red.

Notes:

- If a device such as microwave oven, wireless LAN card, Bluetooth device or any other device that uses the same 2.4GHz frequency is placed near the system, some sound interruption may be heard due to interference.
- The maximum transmission distance of the wireless signal between the subwoofer and sound bar is about 10 metres (32 feet), but may vary depending on your operating environment. If a steel-concrete or metallic wall is between the subwoofer and the sound bar, the system may not operate at all, because the wireless signal cannot penetrate metal.
- Please check that the volume level of the subwoofer is set to your preference.
- This system has a surround function compatible with Dolby Atmos.

Caution:

- Keep the subwoofer away from water and moisture.
- To get the optimum listening performance, make sure the area around the sound bar and subwoofer is clear of any obstacles.

General control (continued)

Subwoofer level control (remote control)

To increase or decrease the Subwoofer level, select SW LEVEL +/-.



Notes:

- When sound from the speaker is distorted, decrease the subwoofer level.

Display brightness control (remote control)

Press the DIMMER button to adjust the brightness of the display.

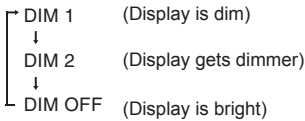

3D sound mode

You can also enjoy the stereoscopic sound regardless of the number of channels (monaural, stereo, multi-channel) of the audio signal in 3D surround sound mode.

Press the 3D button on remote control or 3D Surround button on sound bar repeatedly to select the:

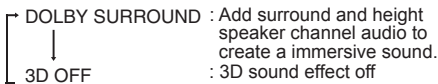

Notes:

- 3D surround mode may change to match the sound mode.

Volume control

Press the VOLUME + button to increase the volume and the VOLUME – button for decreasing.



Notes:

- When the volume is set to 50 or more and the power is turned off, the volume will be 50 when the next power is turned on.

Muting (remote control)

The volume is muted temporarily when pressing the MUTE button on the remote control. Press again to restore the volume.



Dynamic range sound (DRC function) (remote control)

Compress the dynamic range of the audio signal (the range from the maximum volume to the minimum volume). It makes it easier to hear sounds.

Press the DRC button repeatedly to select the:

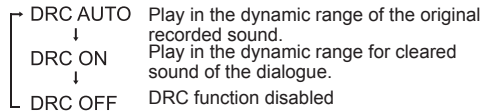

Notes:

- The DRC function works only when Dolby format is played.

General control (continued)

■ Bass and Treble Control (remote control)

Treble Control

1. Press the TREBLE button.
2. Within 5 seconds, press the ∇ / \blacktriangle button to adjust the treble.

TREBLE+3
-5 \leftrightarrow -4 \leftrightarrow +4 \leftrightarrow +5

Bass Control

1. Press the BASS button.
2. Within 5 seconds, press the ∇ / \blacktriangle button to adjust the bass.

BASS +3
-5 \leftrightarrow -4 \leftrightarrow +4 \leftrightarrow +5

■ AV SYNC control (remote control)

AV Sync : Audio Video Synchronization. The audio output can be adjusted to minimise the time gap between the audio output and a visual display.

1. Press the DELAY button.
2. Within 5 seconds, press the ∇ / \blacktriangle button to adjust.
[DLY AUTO \leftrightarrow 0 \leftrightarrow +1 \leftrightarrow +2 \leftrightarrow +3 \leftrightarrow +4 \leftrightarrow +5 \leftrightarrow +6]

■ Speaker output selection (HDMI connection) (remote control)

Press button $\text{TV} \leftrightarrow \text{SB}$ on the remote control until "TV" or "SB" appears on the display to toggle sound output between sound bar or TV.

■ Clear Voice (remote control)

Press the CLEAR VOICE button on the remote control to switch to ON/OFF the function.

The clear voice is a mode to listen to the voice of a person more clearly.

■ Function selection

Press the \ominus button on the sound bar repeatedly or the HDMI IN, ARC, OPTICAL, AUDIO IN, BLUETOOTH, USB button on the remote control to select the desired input source.

HDMI IN	Select the device connected to the HDMI IN (input terminal).
↓	
TV ARC	Select the device connected to the HDMI OUT terminal.
↓	
OPTICAL	Select the device connected to the OPTICAL terminal.
↓	
AUDIO IN	Select the device connected to the AUDIO IN terminal.
↓	
BT	Select the BLUETOOTH connected device.
↓	
USB	Select the device connected to the USB terminal.

■ Sound Mode (remote control)

To change to a different mode, press the desired sound mode button on the remote control.

CINEMA	(for cinema sound effect)
MUSIC	(for standard sound effect)
OUTDOOR SPORT	(for outdoor sport broadcasting)
INDOOR SPORT	(for indoor sport broadcasting)
NEWS	(for news)
NIGHT	(for night)
DIRECT	(for flat sound effect)

■ Audio Switching (remote control)

When viewing audio multiplex broadcasting, you can switch between main audio and sub audio. Press the AUDIO button repeatedly to select the:

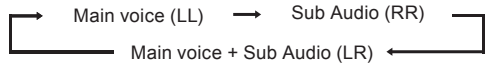

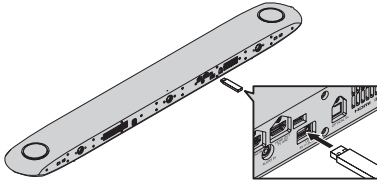

Note:

This product is not compatible with MTP and AAC file systems from USB mass storage device or MP3 player.

■ To playback USB

- 1 Press the button on the sound bar repeatedly or the USB button on the remote control. "USB" appears on the display. Connect the USB memory device containing MP3/FLAC/WAV files.
- 2 Press the button to start playback.
- 3 Select desired folder to be played back by pressing the button.

■ Various USB functions (remote control)

Function	Remote control	Operation
Play/ Pause		To play or pause
Skip Up/ Fast Forward		<ul style="list-style-type: none"> ● Skip to next song. ● Press and hold to fast forward.
Skip Down/ Fast Reverse		<ul style="list-style-type: none"> ● Skip to song beginning. ● Press and hold to fast reverse.
Info		Toggle track information. Counter display ↓ Title display ↓ Artist display ↓ Album display ↓ Format display ↓ Bitrate display
Repeat		1 track → all tracks → random → off

Note:

Fast forward/reverse is invalid when playback a variable bitrate file.

■ To remove USB memory device

- 1 Turn off the sound bar.
- 2 Unplug USB memory device from the USB terminal.

Notes:

- SHARP will not be held liable for the loss of data while the USB memory device is connected to the audio system.
- This USB memory's format supports FAT 32.
- SHARP cannot guarantee that all USB memory devices will work on this audio system.
- USB cable is not recommended for use in this audio system to connect to USB memory device. Use of the USB cable will affect the performance of this audio system.
- This USB memory cannot be operated via USB hub.
- The USB terminal in this unit is not intended for a PC connection but is used for music streaming with a USB memory device.
- External HDD-storage cannot be played back via USB terminal.
- If the data inside the USB memory is large, it may take longer time for the data to be read.
- This product can play MP3, FLAC, WAV files. It will automatically detect the file type being played. If unplayable file is played on this product, the file will be automatically skipped. This will take a few seconds.
- This product relates to USB mass storage devices. It may however face some irregularities due to various unforeseen reasons from some devices. Should this happen, turn off the unit and then turn it on again.
- Maximum total number supported for files is 999. However, it is advisable to playback a media with a small amount of files to maximise playability.

■ Repeat/Random play (remote control)

- Repeat play can play one track or all tracks.
- The tracks on the device can be played in random order automatically.

Press the REPEAT button to select:

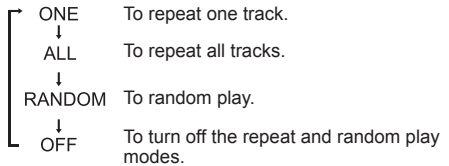

Notes:

- If you press the button during random play, you can move to the track selected next by the random operation. On the other hand, the button does not allow you to move to the previous track. The beginning of the track being played will be located.
- In random play, the unit will select and play tracks automatically. (You cannot select the order of the tracks.)

Listening to *Bluetooth* enabled devices

■ *Bluetooth*

Bluetooth wireless technology is a short-range radio technology that enables wireless communication between various types of digital devices, such as mobile phone or computer. It operates within a range of about 10 meters without the hassle of having to use cables to connect these devices.

This unit supports the following:

Communication System: *Bluetooth* Specification version 5.1 *Bluetooth* + Enhanced Data Rate (EDR).

Support Profile : A2DP (Advanced Audio Distribution Profile) and AVRCP (Audio/Video Remote Control Profile)

Notes when using unit with a mobile phone

- This unit cannot be used to talk over the telephone even when there is a *Bluetooth* connection made to a mobile phone.
- Please refer to the operating manual supplied with the mobile phone for details on operation of your mobile phone while transmitting the sound using a *Bluetooth* connection.

■ Pairing *Bluetooth* devices

Bluetooth devices need to be initially paired first before they can exchange data. This unit can memorise up to a maximum of 8 devices. Once paired, it is not necessary to pair them again unless:

- pairing is made with more than 8 devices. Pairing can only be made one device at a time. If subsequent device is paired, the oldest device paired will be deleted and replaced with the new one.
- this unit is reset. All pairing information is deleted when unit is reset.

Indicators on the sound bar:

Sound Bar display	<i>Bluetooth</i> status
PAIRING appears	In waiting or pairing mode
PAIRED appears	Connected

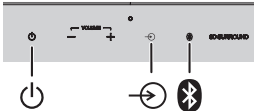

■ Pairing with *Bluetooth* source devices

- 1 Press the button on the sound bar or ON-STANDBY button on the remote control to turn the power on.
- 2 Press the button on the sound bar repeatedly or the BLUETOOTH button on the remote control. "BT" appears on the display.
- 3 Perform pairing procedure on the source device to detect this unit. "HT-C21DS1 SHARP" will appear in the detected devices list (if available) in the source device. (Refer the source device operating manual for details).

Notes:

- Place the devices to be paired within 1 meter of each other when pairing.
 - Some source devices are unable to display lists of detected devices. To pair this unit with the source device, refer to the source device operating manual for details.
- 4 Select "HT-C21DS1 SHARP" from the source list. If Passcode* is required, enter "0000".
* Passcode may be called PIN Code, Passkey, PIN number or Password.
 - 5 "PAIRED" appears on the display for 3 seconds once the unit is successfully paired with the source device. (Pairing information is now memorised in the unit.) Some audio source devices may connect with the unit automatically after pairing is completed, otherwise follow the instructions in the source device operating manual to start connection.
 - 6 Press the button on the remote control or source device to start *Bluetooth* streaming playback.
 - 7 Press the / PAIRING button to disconnect current source device. Unit now is in PAIRING mode. New device can be connected or current device can be reconnected.

Notes:



- If a device such as microwave oven, wireless LAN card, *Bluetooth* device or any other device that uses the same 2.4 GHz frequency is placed near the system some sound interruption may be heard.
- The transmission distance of the wireless signal between the device and the main unit is about 10 m, but may vary depending on your operating environment.
- If a steel concrete or metallic wall is between the device and the main unit, the system may not operate at all, because the wireless signal cannot penetrate metal.
- If this unit or the source device is turned off before *Bluetooth* connection is completed, pairing will not be completed and the pairing information will not be memorised. Repeat step 1 onwards to start pairing again.
- To pair with other devices, repeat steps 1 - 4 for each device. This unit can memorise up to a maximum of 8 devices. If subsequent device is paired, the oldest device paired will be deleted.
- Once a device is ousted or deleted from the pairing list, the pairing information for the device is also deleted. To listen to the sound from the device again, it needs to be re-paired. Perform steps 1 - 4 to pair the device again.

Listening to *Bluetooth* enabled devices (continued)

■ Listening to the sound

Check that:

- The source device *Bluetooth* functionality is ON.
- Pairing of this unit and the source device is completed.
- Unit is in connected mode.

- 1 Press the  button on the sound bar or the ON/STANDBY button on the remote control to turn the power on.
- 2 Press the  button on the sound bar repeatedly or the BLUETOOTH button on the remote control. "BT" appears on the display.
- 3 Start the *Bluetooth* connection from the *Bluetooth* stereo audio source device.
- 4 Press the  button on the remote control or source device to start *Bluetooth* streaming playback.

Notes:





- If the source device has an extra bass function or equalizer function, set them to off to avoid sound distortion.
- Make the *Bluetooth* connection again if the source device is not turned on, or its *Bluetooth* functionality is off or is in sleep mode.

■ To disconnect the *Bluetooth* device

Perform any of the followings.

- Disconnect the *Bluetooth* connection on the audio source device. Refer the operating manual supplied with the device.
- Turn off the *Bluetooth* stereo audio source device.
- Turn off this unit.

■ Various *Bluetooth* functions (remote control)

Function	Remote control	Operation
Play/Pause		To play or pause.
Skip Up/ Fast Forward		<ul style="list-style-type: none"> ● Skip to next song. ● Press and hold to fast forward.
Skip Down/ Fast Reverse		<ul style="list-style-type: none"> ● Skip to song beginning. ● Press and hold to fast reverse.
Info		Display title, artist, album name if available.

Note:

Fast forward/reverse is invalid depends on the device connected.

About various decoders

Various decoders compatible with Dolby method of digital broadcasting, PCM method are carried in this product.

Decoder	Description
Dolby Digital	It is a sound compression technology compatible with multi-channel adopted for DVD etc. With this unit you can enjoy the sound of Dolby Digital such as DVD.
Dolby Digital Plus	Compared to Dolby Digital, it is a voice compression technology that has higher sound quality and supports multiple channels. With this unit, you can enjoy the sound of Dolby Digital Plus such as BD
Dolby TrueHD	Compared to Dolby Digital Plus, it is a voice compression technology that has higher sound quality and supports multiple channels. You can play audio with the same sound quality as the original sound. With this unit, you can enjoy the sound of Dolby TrueHD such as BD.
Dolby Atmos	This is an option of audio format of Dolby Digital Plus or Dolby TrueHD adopted for BD etc. It is a technology to realize a more stereoscopic sound field by introducing a sound field above the listener. With this unit, you can enjoy the sound of Dolby Atmos such as BD.
PCM	It is one of the methods of converting voice etc. adopted for CD, DVD etc. into numerical value to make it digital data. With this unit, you can enjoy PCM audio such as CD and DVD.

Troubleshooting chart

Many potential problems can be resolved by the owner without calling a service technician.

If something is wrong with this product, check the following before calling your authorised dealer or service centre.

■ General

Symptom	Possible cause
<ul style="list-style-type: none"> No sound is heard. 	<ul style="list-style-type: none"> The input signal (selection) is not set properly. The volume level is set to "0". Muting is activated. The equipment used with this system is not HDMI compliance. The HDMI cable is not correctly connected. Connect the HDMI cable correctly and then perform the reset procedure. (refer page 20) Do not connect or disconnect HDMI cable while power is on. This may lead to operation problems.
<ul style="list-style-type: none"> The sound from subwoofer is not well balanced. 	<ul style="list-style-type: none"> The subwoofer level is set to minimum or maximum level.
<ul style="list-style-type: none"> Noise is heard during playback. 	<ul style="list-style-type: none"> Move the speaker away from any computers or mobile phones.
<ul style="list-style-type: none"> When a button is pressed, the sound bar does not respond. 	<ul style="list-style-type: none"> Set the sound bar to the standby mode and then turn it back on.
<ul style="list-style-type: none"> The power is not turned on. 	<ul style="list-style-type: none"> The sound bar is unplugged. The protection circuit may be activated. Unplug and plug in the power lead again after 5 minutes or more.
<ul style="list-style-type: none"> 3D images and/or 4K content not displayed on the TV. 	<ul style="list-style-type: none"> Depending on the TV and Video component, 3D images and 4K content may not be displayed. Check the operation manual of the respective component. HDMI cable not support 3D images and 4K content.
<ul style="list-style-type: none"> Background noise appears when connecting with RCA audio output terminal connection from a TV-set/ Blu-ray/DVD Disc Player. 	<ul style="list-style-type: none"> Please change to HDMI/ARC or headphone terminal from TV-Set/ Blu-ray/DVD Disc Player. This effect may occur depending on TV/Blu-ray/DVD Disc Player-Brand, model and age, and it is not the sound bar problem.
<ul style="list-style-type: none"> Wireless connection cannot be established. 	<ul style="list-style-type: none"> Check the distance between the sound bar and subwoofer (less than 10 metres (32 feet)). Make sure there is no other wireless devices near the unit. Make sure there is no obstacles (especially metal) blocking between the sound bar and subwoofer. Manually re-link the sound bar and subwoofer (refer page 13).

■ Remote control

Symptom	Possible cause
<ul style="list-style-type: none"> The remote control does not operate properly. 	<ul style="list-style-type: none"> The battery polarity is incorrect. The battery is dead. The distance or angle is incorrect. There are obstructions in front of the sound bar. There is a strong light shining on the remote sensor. The remote sensor for another equipment is used simultaneously.
<ul style="list-style-type: none"> The sound bar cannot be turned on with the remote control. 	<ul style="list-style-type: none"> The AC power lead of the sound bar is not plugged in. Battery is not inserted.

■ Bluetooth

Symptom	Possible cause
<ul style="list-style-type: none"> No sound is heard. 	<ul style="list-style-type: none"> The unit is too far from the <i>Bluetooth</i> stereo audio source device. The unit is not paired with the <i>Bluetooth</i> stereo audio source device.
<ul style="list-style-type: none"> <i>Bluetooth</i> sound is interrupted or distorted. 	<ul style="list-style-type: none"> The unit is too near to a device that generates electromagnetic radiation.

■ USB

Symptom	Possible cause
<ul style="list-style-type: none"> Device cannot be detected. Playback does not start. 	<ul style="list-style-type: none"> There is no MP3/WAV/FLAC file inside the device. The device is not properly plugged in. An MTP device is plugged in. The device contains AAC file only. A false MP3/WAV/FLAC file is being played back.

Troubleshooting chart (continued)

■ Condensation

Sudden temperature changes, storage or operation in an extremely humid environment may cause condensation inside the cabinet or on the transmitter on the remote control. Condensation can cause the sound bar to malfunction. If this happens, leave the power on until normal playback is possible (about 1 hour). Wipe off any condensation on the transmitter with a soft cloth before operating the sound bar.

■ If problem occurs during operation

When this product is subject to strong external interference (mechanical shock, excessive static electricity, abnormal supply voltage due to lightning, etc.) or if it is operated incorrectly, it may malfunction.



If such a problem occurs, do the following:

1. Set the sound bar to the standby mode and turn the power on again.
2. If the sound bar is not restored in the previous operation, unplug and plug in the sound bar again, and then turn the power on.

■ Factory reset, clearing all memory

Make sure to disconnect all output and input cables attached to the sound bar before performing the factory reset.

Soundbar

1. Press the  button on the sound bar to enter the standby mode. Sound bar indication light up in red.
2. While pressing the 3D SURROUND button on sound bar, press and hold the  button.
3. "RESET" appears on the display.
4. Unplug and plug in the AC power lead.

Subwoofer

Before performing the subwoofer reset, sound bar's AC power lead must be unplugged.

1. Plug the AC power lead, the Power/Pairing indicators will blink in blue.
2. Press and hold the SW LINK button at back of the subwoofer until the Power/Pairing indicator blue blink slower.
3. Press the SW LINK button once, then press and hold the SERVICE B button until the Power/Pairing indicator blinks.
4. Press the SW LINK button again and Power/Pairing indicator blue blinking again.
5. Unplug and plug in the AC power lead.

Caution:

This operation will erase all data stored in memory.

Maintenance

■ Cleaning the cabinet

Periodically wipe the cabinet with a soft cloth.

Caution:

- Do not use chemicals for cleaning (petrol, paint thinner, etc.). It may damage the cabinet finish.
- Do not apply oil to the inside of each component. It may cause malfunctions.

Error indicators and warnings

When you fail to perform operations properly, the following messages are displayed.

On sound bar	Meaning
 Power indicator (blinks red)	<ul style="list-style-type: none">● When the protection circuit is activated.
NOT SUPP	<ul style="list-style-type: none">● When there is no compatible sound input.

Note:

Should the same message appear even if the sound bar is unplugged and plugged in, or is set to the standby mode and on again, contact your local dealer where you purchased the sound bar.

Specifications

As part of our policy of continuous improvement, SHARP reserves the right to make design and specification changes for product improvement without prior notice. The performance specification figures indicated are nominal values of production unit. There maybe some deviations from these values in individual unit.

■ Sound Bar

Power source	AC 220 - 240 V ~ 50/60Hz
Power consumption	30 W
Dimensions	Width: 1200 mm Height: 60 mm Depth: 140 mm
Weight	4.2 kg
Output power	RMS: Total 100 W (50 W + 50 W) (10% T.H.D.)
Output terminal	HDMI™ output: (audio/video support up to 4K) x 1
Input terminal	500 mV / 47 kΩ (AUDIO IN) Optical digital input (OPTICAL): Square type x 1 HDMI input: (audio/video support up to 4K) x 1
Speaker system	Type: 3-way Bass Reflex Stereo speaker system Woofer (front): 8 Ω, 4 cm x 7 cm, 2 pcs/Ch (total 4 pcs) Mid Range (top): 24 Ω, 5.7 cm, 1 pcs/Ch (total 2 pcs) Soft dome: 8 Ω, 2 cm, 1 pcs/Ch (total 2 pcs)

■ Bluetooth

Version	V 5.1 BR + EDR
Maximum power transmitted	< 20 dbm
Bluetooth Frequency band	2.402 GHz - 2.480 GHz
Compatible Bluetooth Profile	A2DP AVRCP

■ USB

USB host interface	<ul style="list-style-type: none"> ● Complies with USB 1.1 (Full Speed)/2.0 Mass Storage Class. ● Support Bulk only and CBI protocol.
Supported files	● MPEG 1 Layer 3 / FLAC / WAV
Bitrate support	<ul style="list-style-type: none"> ● MP3 (.mp3) Bitrate support: 32k ~ 320kbps Sampling frequency: 32k, 44.1k, 48 kHz ● WAV (.wav) Bitrate support: 64 ~ 1536kbps (LPCM) Sampling frequency: 32k, 44.1k, 48k, 88.2k, 96k, 176.4k, 192kHz Quantization Bit: 16, 24bit ● FLAC (.flac) Bitrate support: 128 ~ 2304kbps Sampling frequency: 32k, 44.1k, 48k, 88.2k, 96k, 176.4k, 192kHz Quantization Bit: 8, 16, 24bit
Other	● Maximum total number of files is 999.
File system support	● Support USB devices with FAT 32.

■ Subwoofer

Power source	AC 220 - 240 V ~ 50/60 Hz
Power consumption	28 W
Output power	RMS: 150 W (10% T.H.D.)
Type	Subwoofer system 16 cm woofer (3 Ω)
Dimensions	Width: 130 mm Height: 430 mm Depth: 306 mm
Weight	5.0 kg