

SHARP



Refrigerant: R600a

Insulation blowing gas: Cyclopentane

冷媒種類 : R600a

絕緣發泡材主要成份 : 環戊烷

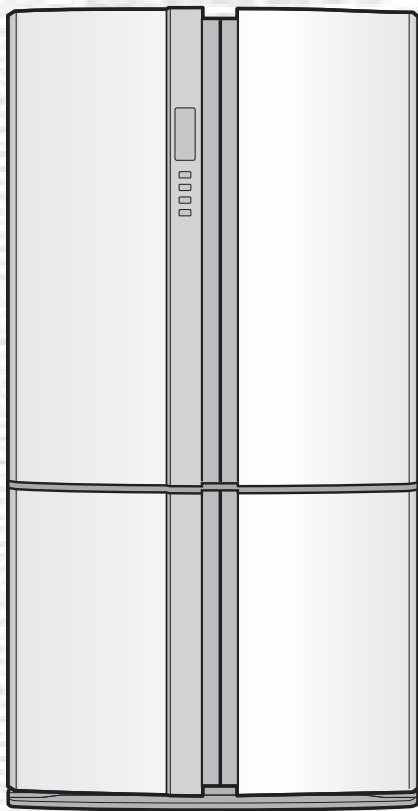

Refrigerator - Freezer Operation manual

Contents

• Safety information	3
• Installation.....	5
• Description	6
• Useful modes	7
• Control panel	8
• Storing food	10
• Care and cleaning.....	11
• Before you call for service.....	12

原裝進口電冰箱 使用說明書

目錄

• 安全注意事項	13
• 安裝	15
• 各部位名稱	16
• 實用功能	17
• 控制面板	18
• 食品的儲存	20
• 保養	21
• 送修之前的初步檢查	22



“Plasmacluster” and “Device of a cluster of grapes” are trademarks of Sharp Corporation.

(Only for SJ-F85VM, SJ-F95VM, SJ-FTF22AVP, SJ-FTF24AVP)

SJ-F85VM-SS SJ-F95VM-SS
SJ-FTF22AVP-SL SJ-FTF24AVP-SL
SJ-VX74E-SL SJ-VX79E-SL

Thank you very much for buying this SHARP product. Before using your SHARP refrigerator, please read this operation manual to ensure that you gain the maximum benefit from it.

- This refrigerator is intended for making ice cubes, refrigerating and freezing foods.
- This refrigerator is for household use only, with ambient temperature indicated in the table. The climate class is specified on the rating plate. The refrigerator is fully functional at the ambient temperature range of the indicated climate class. If the refrigerator is used at colder temperatures, the refrigerator will not be damaged up to a temperature of +5°C.
- The refrigerator should not be subjected to temperatures of -10°C or below for a long period of time.

Household use only	
Climate class	Acceptable range of ambient temperature
SN	+10°C to 32°C
N	+16°C to 32°C
ST	+16°C to 38°C
T	+16°C to 43°C

Safety information

 **Warning** This means that there are high risks of death or serious injury.

 **Caution** This means that there are high risks of material damage or personal injury.



Warning

Refrigerant

This refrigerator contains flammable refrigerant (R600a: isobutane) and insulation blowing gas (cyclopentane). Observe the following rules to prevent ignition and explosion.

- Do not allow any sharp objects to have contact with the refrigeration system. The refrigeration system behind and inside the refrigerator contains refrigerant.
- Do not use mechanical devices or other means to accelerate the defrosting process. (This refrigerator has adopted automatic defrosting system.)
- Do not use electrical appliances inside the refrigerator.
- Do not block the space around the refrigerator.
- Do not use flammable sprays, such as spray paint near the refrigerator.
- In the case of failure of the refrigeration system, do not touch the wall socket and use open flames. Open the window and air out the room. Then ask a service agent approved by SHARP for service.

Installation

- Do not install the refrigerator in a damp or wet location. It may cause the damage to the insulation or electrical leak. Dew may also appear on the outer cabinet and it causes rust.
- The refrigerator should be installed flatly and firmly on the floor.

Power cord, Plug, Socket

Read carefully the following rules to prevent electric shock or fire.

- Connect the power plug into the wall socket firmly and directly. Do not use an extension cord or adapter plug.
- Connect the power plug to the socket with the required rated voltage.
- Connect the earth pin to the earth terminal properly. (3 pin plug region)
- Connect the earth wire which is installed at the rear of the product to the earth terminal properly. (2 pin plug region)

- Make sure that the power cord has not been damaged during installation or moving. If the power plug or cord is loose, do not insert the power plug.
- Do not touch the power plug with wet hands.
- Disconnect from the main electricity supply by removing the main plug from the socket. Do not remove by pulling the power cord.
- Dust deposited on the power plug may cause fire. Wipe it off carefully.
- Pull out the plug if the refrigerator is not used for a long time.
- Should the flexible supply cord be damaged, it must be replaced by service agent approved by SHARP, a special cord is required.

In use

- Do not store volatile and flammable materials such as ether, petrol, propane gas, aerosol cans, adhesive agents and pure alcohol etc. These materials are easy to explode.
- Do not store temperature-sensitive products such as pharmaceutical products in the refrigerator. There are high risks of changes in product quality.
- Do not attempt to change or modify this refrigerator. This may result in fire, electric shock or injury.
- Do not place any object on the top of refrigerator. If the object falls down from the top, it may cause injury.
- This appliance can be used by children aged from 8 years or above and persons with reduced physical, sensory or mental capabilities or lack of experience and knowledge if they have been given supervision or instruction concerning use of the appliance in a safe way or understanding the hazards involved. Children shall not play with the appliance. Cleaning and user maintenance shall not be done by children without supervision.
- Do not use other than potable water to make ice cubes.

Care and Cleaning

- Unplug the refrigerator first to prevent electric shock.
- Do not splash water directly on the outer cabinet or the interior. This may lead to rusting and deterioration of the electrical insulation.

Trouble

- If you smell something burnt, pull out the power plug immediately. Then ask a service agent approved by SHARP for service.
- In case of gas leak, ventilate the area by opening window. Do not touch the refrigerator or the power socket.



Caution

Transportation

- When you install or move your refrigerator, use curing mat to protect the floor from being damaged.
- Carry the refrigerator by holding the handles located on the rear and bottom side. If you lift up the refrigerator improperly, it may cause injury.

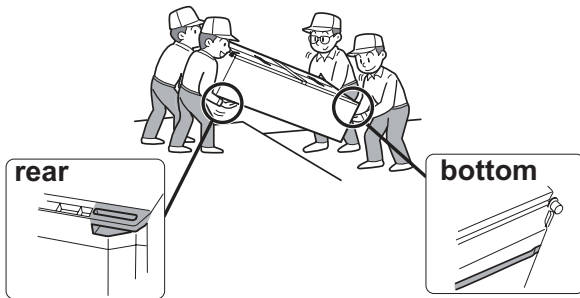

Disposal

- Ensure that the refrigerator presents no danger to children while being stored for disposal. (e.g. remove the magnetic door seals to prevent child entrapment.)
- This refrigerator should be disposed appropriately. Take the refrigerator to a professional recycling plant for flammable refrigerant and insulation blowing gases.

In use

- Do not touch the compressor unit or its peripheral parts, as they become extremely hot during operation and the metal edges may cause injury.
- Do not touch foods or metal containers in the freezer compartment with wet hands. This may cause frostbite.
- Do not place bottled drinks and cans in the freezer compartment. Especially "Express cool" is in operation, there is a high risk that glass bottles may burst.
- Do not open or close the door when other people put a hand near the door. There is a risk that the other people may get their fingers caught in the door.
- Do not put oversized object in the pockets of the door. If the object falls down from the pockets, it may cause injury.

1 Keep adequate ventilation space around the refrigerator.

- The figure shows the minimum required space for installing the refrigerator. The measurement condition of power consumption is conducted under a different space dimension.
 - By keeping greater space, the refrigerator may consume a less amount of power consumption.
 - If use the refrigerator in the smaller space dimension than figured, it may cause temperature rise in the unit, loud noise and failure.
 - The space between the rear of the refrigerator and the wall should be 60mm or more, and less than 75mm.
- If the space is wider than 75mm, you may get injured by touching compressor and its peripheral parts which are extremely hot during the operation.

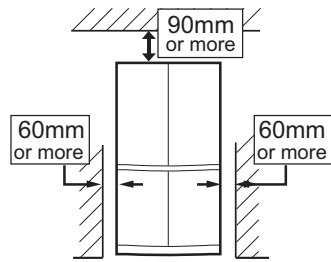

4 Remove the 4 screws of the lower part of the cabinet and use these screws to set the foot cover. (The foot cover is packed inside the refrigerator compartment.)

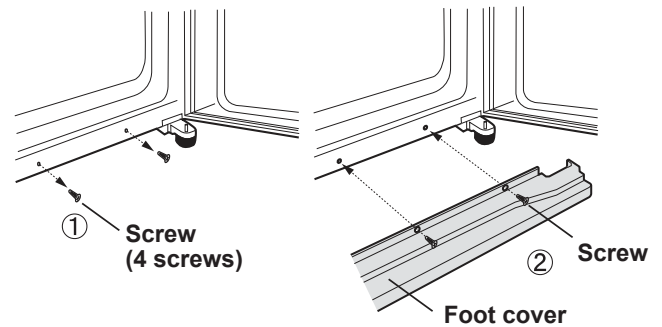

Note

- Place your refrigerator to access the plug.
- Keep your refrigerator out of direct sunlight and do not place next to heat generating appliance.
- Do not place your refrigerator directly on the ground. Insert suitable stand such as wooden board under the refrigerator.
- When you insert the power plug with the door opened, door alarm sounds but it is not abnormal. This sound stops after closing the door.

Before using your refrigerator

Clean the inside parts with a cloth soaked in warm water.
If soapy water is used, wipe it off thoroughly with water.

Overall space required in use

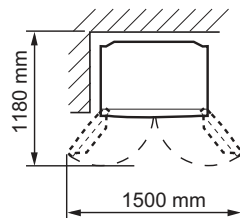

2 Use the two front the adjustable feet to place the refrigerator flatly and firmly on the floor.

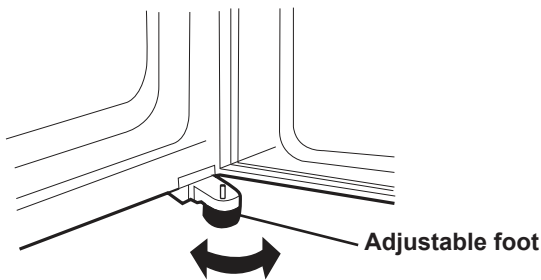

3 When right and left doors are not properly aligned, adjust using the adjustable feet.

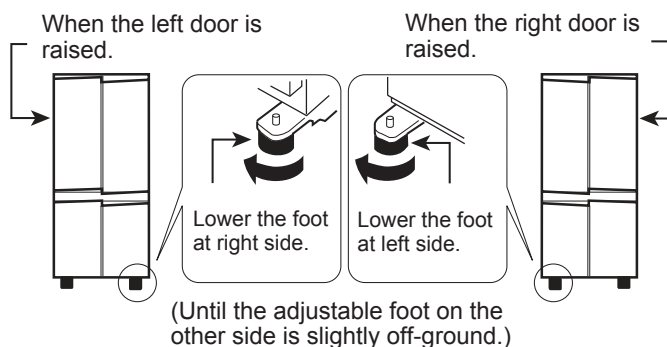

Description

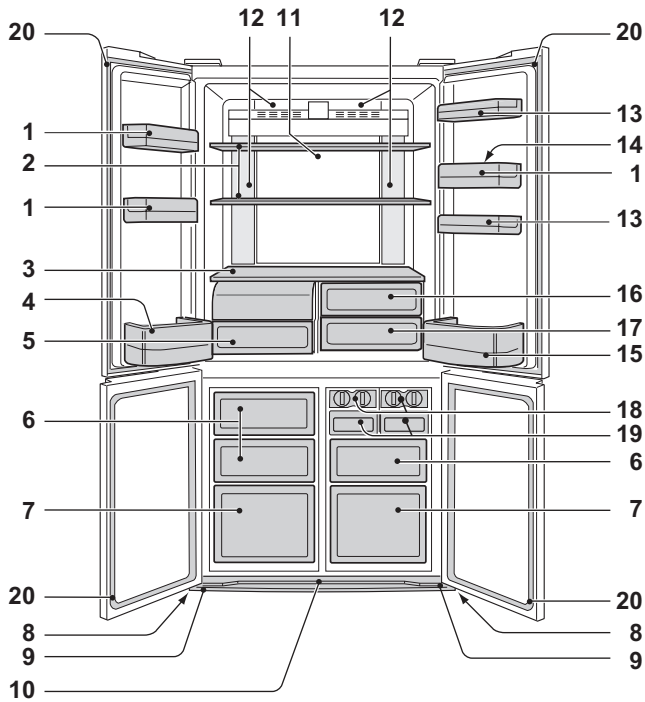

SJ-F95VM/ SJ-FTF24AVP/SJ-VX79E

- 1. Door pocket (3 pcs)
- 2. Refrigerator shelf (2 pcs)
- 3. Shelf
- 4. Bottle pocket (left)

5. Fruit and vegetable crisper
The cover of the fruit and vegetable crisper opens as the case is pulled.

- 6. Freezer case (small) (3 pcs)
- 7. Freezer case (large) (2 pcs)

8. Caster (4 pcs)
The casters allow the refrigerator to move back and forth.

9. Adjustable foot (2 pcs)

10. Foot cover

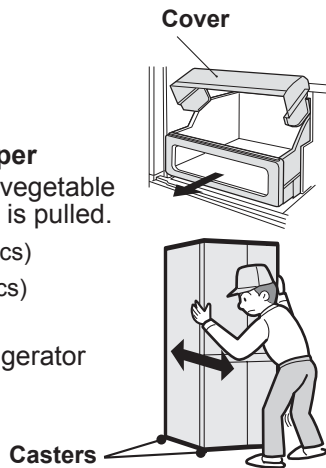

11. Hybrid cooling panel

The panel cools the refrigerator compartment indirectly from the rear. In this way, food is cooled gently without being exposed to cold air flow.

12. Light

13. Utility pocket

(SJ-F95VM, SJ-FTF24AVP, SJ-VX79E : 2 pcs)
(SJ-F85VM, SJ-FTF22AVP, SJ-VX74E : 1 pc)

14. Egg holder

15. Bottle pocket (right)

To store large-size bottles, move the partition all the way back.

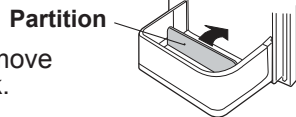

16. Fresh case (upper)

17. Fresh case (lower)

18. Ice cube maker (2 pcs)

- 1) Do not overfill this tray with water. Otherwise the ice cubes will join together when frozen.
- 2) When ice cubes are made, turn the lever clockwise to put the ice into the ice cube box.

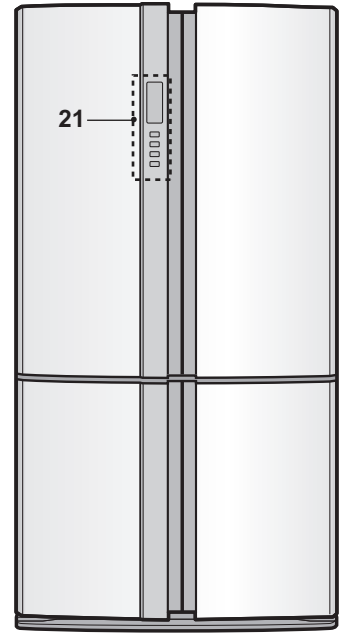
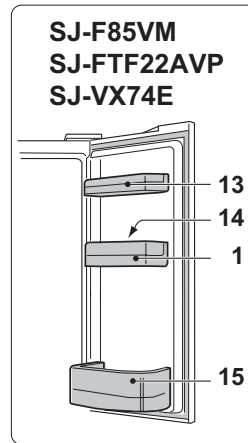
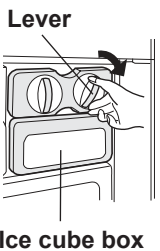

19. Ice cube box (2 pcs)

Note

To prevent the ice cube box from being damaged, do not pour oil into the box or make ice in it.

20. Magnetic door seal (4 pcs)

21. Control panel

Deodorizing unit

Deodorizing catalyst is installed on the routes of cold air. There is no need to operate and clean.

More food can be stored by taking out the internal accessories with normal cooling operation.

How to remove the fruit and vegetable crisper cover

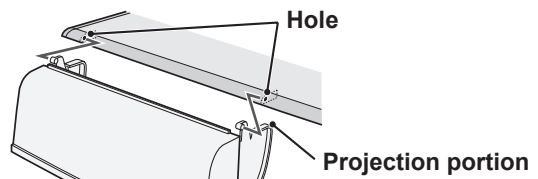

How to remove

To remove the partition, pull it to the front with pushing the claw.

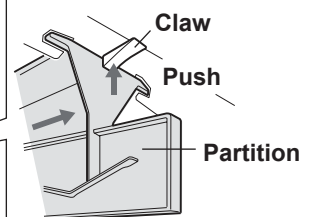

How to set

Insert the four projections into the upper parts.

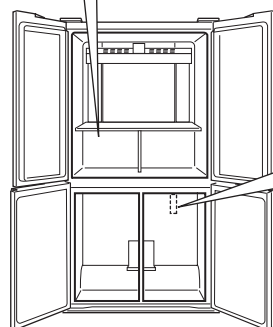

Useful modes

As for the operations, refer to chapter "Control panel".

-  **Extra cool**
-  **Express freezing**
-  **Express cool**

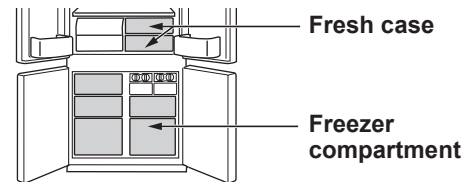

	Extra cool	Express freezing	Express cool
Feature	This mode is to cool beverages or foods to ice-cold. Note : Food with high-moisture may freeze.	This mode speeds up the time to freeze food.	This mode is to cool beverages or foods quickly.
Point of use	Fresh case	Freezer compartment	Freezer compartment Caution : Do not place glass bottles. There is a high risk that they may burst.
Operating time	6 hours *1	2 hours *1	30 minutes
	<ul style="list-style-type: none"> • This mode ends automatically. • The alarm does not sound. 		<ul style="list-style-type: none"> • This mode ends automatically. • The alarm sounds. <p>To stop the alarm *2</p> <p>Press enter button. </p>
After the operation completed	<ul style="list-style-type: none"> • There is no need for taking beverages or foods out. 		<ul style="list-style-type: none"> • Be sure to take the beverages and foods out when the alarm sounds. • If the beverages and foods are left in the freezer compartment over approximately 30 minutes, they may freeze.
At the time of power failure during the operation	<ul style="list-style-type: none"> • This mode is automatically cancelled. 		<ul style="list-style-type: none"> • This mode is automatically restarted from the previous state at the time of re-power.

*1 It may take more time to complete if the operation overlaps with defrosting. This mode starts after defrosting is completed.

*2 If you do not stop the alarm, it sounds 30 minutes continuously.

Note

- Extra cool, Express freezing and Express cool are not available at the same time while one of the modes is in operation.
- Avoid opening the door as much as possible during the operations of these modes.

Plasmacluster (Only for SJ-F85VM, SJ-F95VM, SJ-FTF22AVP, SJ-FTF24AVP)

Use this feature when you want to keep the inside of the refrigerator clean.

The ionizer inside your refrigerator releases clusters of ions, which are collective masses of positive and negative ions, into the refrigerator compartment. These ion clusters inactivate airborne mold fungus.

Note

- There may be a slight odor in the refrigerator. This is the smell of ozone generated by the ionizer. The amount of ozone is minimum and quickly disappears in the refrigerator.

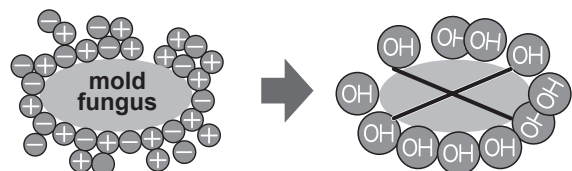

Control panel

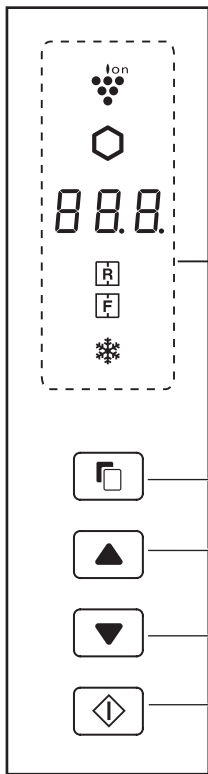

Select button

Switching button

Enter button

Useful modes

Icon	Meaning	Default setting
	Plasmacluster *1	OFF
	Extra cool	
	Express freezing	
	Express cool	

Controlling temperature

Icon	Meaning	Default setting
	Refrigerator compartment	3°C
	Freezer compartment	-18°C

Additional modes

Indicator	Meaning	Default setting
	Door alarm	ON
	Sound of button operation	

Note

- When you press one of the buttons, all icons flash once and show the standby display. If the refrigerator stops because of power failure, the modes except for Extra cool and Express freezing function the same way as before at the time of re-power.
 - Operation is invalid while the refrigerator door is open.
 - Mode icons or indicators in operation light up on the standby display. When Express cool is in operation, the icon flashes on the standby display.
- Turn-on state
- When there is no operation for approximately 1 minute, the display returns to the standby display automatically. The standby display turns off if there is no operation for another 1 minute.

*1 Only for SJ-F85VM, SJ-F95VM, SJ-FTF22AVP, SJ-FTF24AVP

Operations of useful modes

		Display	
1	Select the mode icon.	(e.g. Extra cool)	
2	Select on/off.		
3	Complete the setting. (Beep)		
	“Express cool” only Complete the setting by pressing for 3 seconds or more. (Beep, Beep, Beep)	Mode icon turns on. “Express cool” only (Flashing)	Mode icon turns off on the standby display.

When press button, the icons change in the order shown as below.

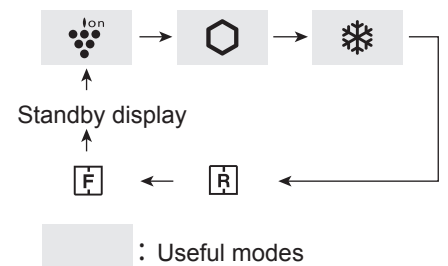

Operation of additional modes

	Summary	Cancel operation	Display
Door alarm	<ul style="list-style-type: none"> • When the refrigerator or freezer door is left open for over 1 minute, door alarm sounds once, and again after 1 minute. • If the door is left open for approx. 3 minutes, the alarm sounds continuously. • The alarm stops after close all the door. 	Press and simultaneously for 3 seconds or more. (Beep, Beep, Beep)	 The indicator turns off.
Sound of button operation	<ul style="list-style-type: none"> • When you want to switch off button operation sound. 	Press and simultaneously for 3 seconds or more. (Beep, Beep, Beep)	 The indicator turns off.

Note • When you want to turn on the additional mode, follow the same step again. (The indicator turns on.)

Storing food

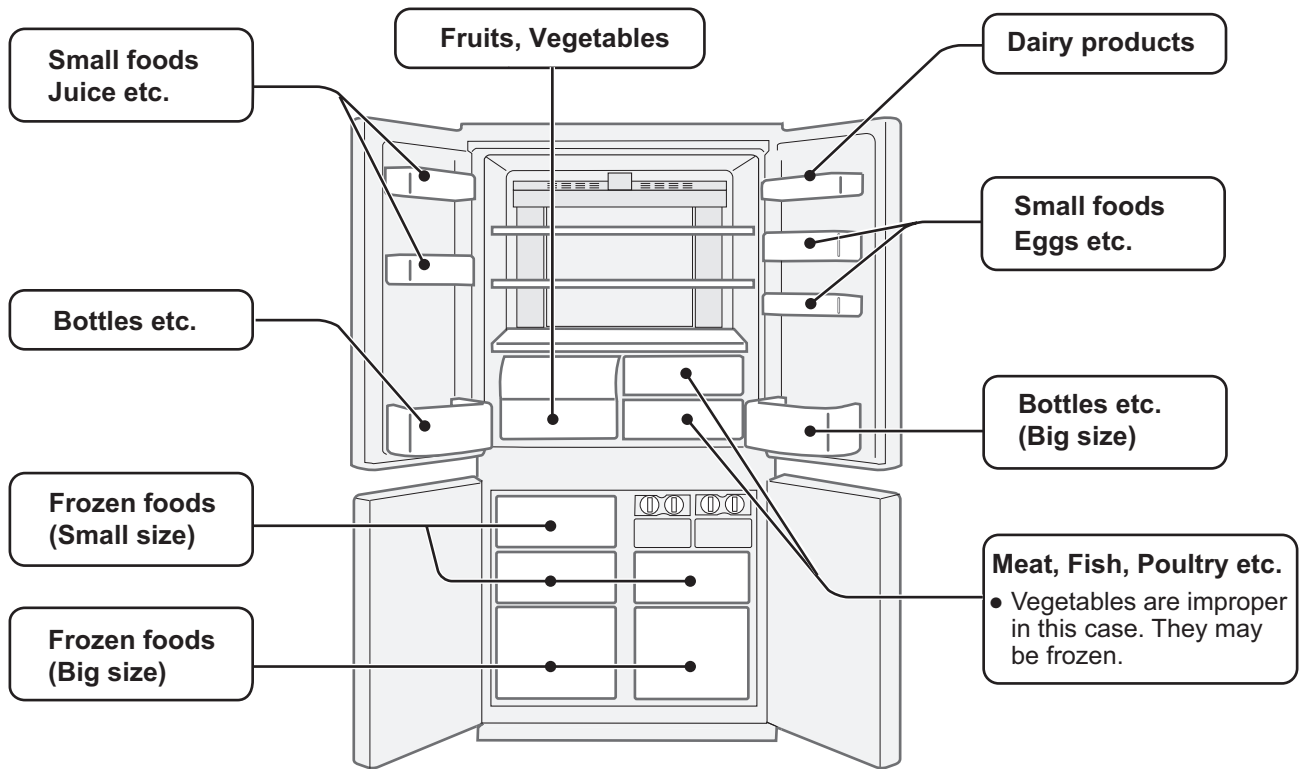

Refrigeration reduces the rate of food spoilage. Ensure that the food is of the freshest possible quality to maximize the shelf life of perishable foods. The following is a general guide to help promote longer food storage.

Fruit / Vegetables

Fruit and vegetables should be loosely enclosed in a plastic material e.g. wrap, bags (do not seal) and placed in the Fruit and vegetable crisper to minimize moisture loss.

Dairy Products & Eggs

- Most dairy products have their best-before date on the outer packaging which informs the recommended temperature and shelf life of the foods.
- Eggs should be stored in the Egg holder.

Meats / Fish / Poultry

- Place on a plate or a dish and cover with paper or plastic wrap.
- For larger cuts of meat, fish, or poultry, place to the rear of the shelves.
- Ensure all cooked food is wrapped securely or placed in an airtight container.

For best freezing

- Quality of foods should be fresh.
- Freeze small quantities of food at a time in order to freeze them quickly.
- Food should be properly sealed or covered tightly.
- Place foods in the freezer evenly.
- Label bags or containers to keep an inventory of freezing food.

Advice for preventing dew or frost inside the refrigerator

- Keep the door securely closed. If the food falls down, it may cause a gap between the cabinet and the door. Move it back to the shelf or the pocket.
- Food with high-moisture should be stored in airtight container or sealed tightly.

Note

- Evenly place the food on the shelves to allow the cooling air to circulate efficiently.
- Hot foods should be cooled before storing. Storing hot foods increases the temperature in the unit and the risk of food spoilage.
- Do not block the outlet and inlet of the cool air circulating circuit with foods or containers; otherwise the foods is not be evenly cooled throughout the refrigerator.

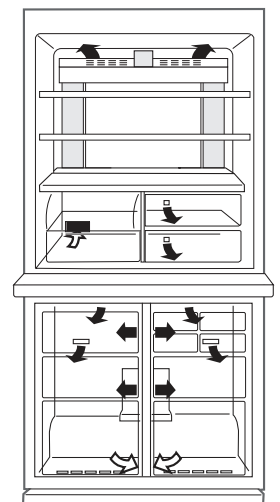

Do not place food directly in front of cold air outlet. This may lead to the food freezing.

Care and cleaning

Important

To prevent cracks on inside surfaces and plastic components, follow these tips.

- Wipe out food oil adhered to plastic parts.
- Some household chemicals may cause damage, so use only diluted washing-up liquid (soapy water).
- If undiluted detergent is used or soapy water is not wiped off thoroughly, it may result in cracks of plastic parts.

Cleaning

- Remove the accessories (e.g. shelves) from the cabinet and the door. Wash them by warm soapy dishwashing water. After that, rinse them in clean water and dry. (Only fruit and vegetable shelf is not removable.)
- Clean the inside with a cloth soaked in warm soapy dishwashing water. Then, use cold water to wipe off soapy water thoroughly.
- Wipe the exterior with a soft cloth each time it gets dirty.
- Clean the Magnetic door seal with a toothbrush and warm soapy dishwashing water.
- Wipe the control panel with a dry cloth.

Note

- Do not use heavy-duty cleansers or solvents (lacquer, paint, polishing powder, benzene, boiled water, etc.) which may cause damages.
- If you pull out the power plug once, wait 5 minutes at least before connecting the power plug again.
- The glass shelves weigh approximately 3 kg each. Hold them firmly when remove from the cabinet and carry.
- Do not drop objects inside the refrigerator or strike the inner wall. This may cause cracks to inner surface.

Before transporting

Wipe up water in the evaporating pan. Before wiping up the water, wait more than 1 hour after pulling out the power plug because refrigeration cycle equipment is extremely hot. (The evaporating pan is located on the rear of the product.)

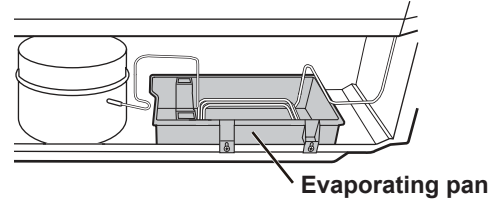

Switching off your refrigerator

If the refrigerator needs to be switched off for an extended period, the following steps should be taken to reduce the growth of mold:

1. Remove all food.
2. Remove the power plug from the socket.
3. Clean and dry the interior thoroughly.
4. Keep all the doors open slightly for a few days to dry.

Defrosting

Defrosting is automatically operated by a unique energy saving system.

When the compartment light is blown

Contact the service agent approved by SHARP to replace the light. The light is not to be replaced other than by qualified service personnel.

Tips for saving energy

- Keep the ventilation space as much as possible around the refrigerator.
- Keep your refrigerator out of direct sunlight, and do not place it next to heat generating appliance.
- Avoid opening the door as much as possible.
- Hot foods should be cooled before storing.
- Place the food evenly on the shelves to allow the cool air to circulate efficiently.

Power consumption

Power consumption of this model is measured according to the international standard of refrigerator performance.

If the refrigerator is operated with the accessories (shaded area) taken out, it works under the most energy efficient condition.

- The amount of power consumption of this model is measured with these accessories taken out as indicated shaded area.

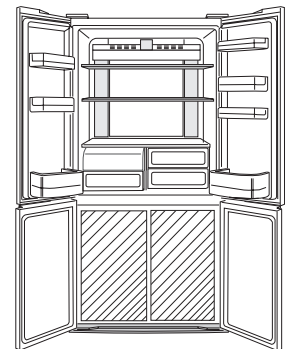

- The amount of power consumption of this model is measured under the space dimensions on the right picture.

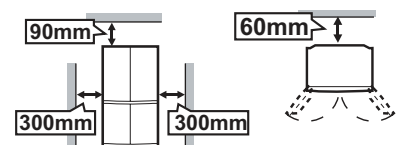

Before you call for service

Before calling for service, check the following points.

Problem	Solution
The outside of the cabinet is hot when touching.	It is normal. The hot pipe is in the cabinet in order to prevent dew generation.
When there is refrigerator noise.	<p>It is normal for the refrigerator to make the following sounds.</p> <ul style="list-style-type: none"> • Loud noise is made by the compressor when its operation starts <ul style="list-style-type: none"> -- Sound becomes quieter after a while. • The compressor makes loud noise once a day. <ul style="list-style-type: none"> -- Operating sound is made immediately after automatic defrost operation. • Sound of flowing fluid (gurgling sound, fizzing sound) <ul style="list-style-type: none"> -- Sound of refrigerant flowing in pipes (sound may become louder from time to time). • Cracking or crunching sound, squeaking sound <ul style="list-style-type: none"> -- Sound produced by expansion and contraction of inner walls and internal parts during cooling.
Frost or dew appears inside or outside the refrigerator.	<p>This may occur in one of the following cases. Use a wet cloth for wiping frost and a dry cloth for wiping dew.</p> <ul style="list-style-type: none"> • When the ambient humidity is high. • When the door is frequently opened and closed. • When foods containing plenty of moisture are stored. (Wrapping is required.)
The foods in the refrigerator compartment freeze.	<ul style="list-style-type: none"> • Is the refrigerator operated for a long time with refrigerator temperature control set at 0°C? <ul style="list-style-type: none"> -- Change the temperature control back to around 3°C. • Is the refrigerator operated for a long time with freezer temperature control set at -21°C? <ul style="list-style-type: none"> -- Change the temperature control back to around -18°C. • If ambient temperature is low, foods may freeze even if the refrigerator compartment is set at 6°C.
Odors in the compartment.	<ul style="list-style-type: none"> • Wrapping is required for the foods with strong odors. • Deodorizing unit cannot remove all odors.
If door alarm does not stop.	<ul style="list-style-type: none"> • The alarm stops after close the door.

If you still require service

Refer to your nearest service agent approved by SHARP.

感謝您購買 SHARP 產品。在使用 SHARP 電冰箱之前，為使您能夠充份使用您所購買的冰箱，請仔細閱讀本使用說明書。

- 本冰箱可用於製作冰塊、冷藏和冷凍食物。
- 這個冰箱僅限於家庭用途，使用冰箱的環境溫度已在表格中寫明。氣候類型已在標牌上詳細說明。
本冰箱在氣候類型指定的環境溫度範圍內可正常使用所有功能。如在較冷的環境溫度下使用本冰箱，則環境溫度需達到 +5°C 才能保證不損壞冰箱。
- 冰箱在一段長時間內不應受到 -10°C 或以下的溫度。

僅限於家庭用途

氣候類型	可接受的環境溫度範圍
SN	+10°C ~ 32°C
N	+16°C ~ 32°C
ST	+16°C ~ 38°C
T	+16°C ~ 43°C

安全注意事項

 **警告** 這表明導致死亡或重傷的風險很高。

 **安全注意事項** 這表明導致材料受損或人員受傷的風險很高。

警告

冷媒種類

冰箱含有易燃製冷劑 (R600a: 異丁烷) 和絕熱發泡氣體 (環戊烷)。為防止著火和爆炸，請遵守以下規則。

- 請務必避免任何尖銳的物體碰觸製冷系統。冰箱內部及後側的製冷系統內含有製冷劑。
- 請勿使用機械設備或其他方式來加速除霜過程。(此冰箱已採用自動除霜系統。)
- 請勿在冰箱內使用電器。
- 請勿堵塞冰箱周圍的空間。
- 請勿在冰箱附近使用易燃性噴霧劑，例如噴漆，否則可能會導致爆炸或火災。
- 如果冰箱的冷卻系統出現故障，請勿接觸牆壁電源插座，也勿使用明火。打開窗戶，使房間空氣流通。然後聯繫 SHARP 認可的售後服務中心進行維修。

安裝

- 請勿將冰箱設置在濕氣多及濺得到水的地方。這樣會因絕緣失效而導致漏電。而且有時會在冰箱外側結露。
- 將冰箱穩妥地安裝在地板的水平位置上。

電源線，插頭，插座

為防止觸電或火災，請仔細閱讀以下規則。

- 直接將電源插頭牢牢地插入牆壁電源插座。請勿使用延長的電線或轉換插頭。
- 將電源插頭插入符合額定電壓要求的插座上。
- 正確地將接地棒連接到接地端子。(3 腳插頭地區)
- 連接其安裝在產品的接地端子的後適當的接地線。(2 腳插頭地區)

- 在安裝或移動的過程中，請確保電源線完好無損。如果電源插頭或電源線出現鬆動等情況，請勿插入電源插頭。
- 請勿用濕手接觸電源插頭。
- 拔出電源插頭時，請不要只拉住電源線，應該拿住插頭端拔出。
- 電源插頭上積滿灰塵是引起火災的原因。因此，請時常將其擦淨。
- 冰箱如果長時間不使用，請將插頭拔出。
- 電源線損壞時 請到 SHARP 認可的售後服務中心更換。因為需要特定的電源線。

使用中

- 請勿儲藏揮發性物質和易燃性物質，如乙醚、汽油、丙烷氧、粘合劑、純乙醇等。此類物質有爆炸之危險。
- 請勿在冰箱內儲存溫度敏感型產品，例如醫藥產品。否則產品極可能會變質。
- 請勿改裝冰箱。修理技術人員以外的人員拆卸和修理本機，會導致火災、觸電和受傷。
- 請勿在冰箱頂部放置任何物品。如果物品從冰箱頂部掉落，可能會導致人員受傷。
- 此冰箱適合 8 歲及以上的兒童使用。在有符合電器使用安全的監督或指導及了解潛在危險的前提下，此冰箱也適合身體、感官或智力方面有缺陷的殘障人士、或者缺乏相關經驗或知識的人士使用。禁止讓兒童玩耍冰箱。在無任何監督的情況下，兒童不得對冰箱進行清潔及維修保養。
- 請勿用飲用水以外的水製作冰塊。

保養

- 為了防止觸電，首先拔掉冰箱的電源插頭。
- 請勿直接將水灑在冰箱的內部和外部。這樣會導致生鏽及絕緣性能下降。

故障

- 如果聞到燒焦的味道，請立即拔出電源線，然後聯繫 SHARP 認可的售後服務中心進行維修。
- 萬一發生瓦斯氣漏事故，請勿用手去觸摸冰箱和插頭，要打開窗戶通風。



安全注意事項

運輸

- 安裝或移動冰箱時，請使用防護墊以防止地板受損。
- 請用冰箱背面和底部的把手進行搬運。如果抬起冰箱的方式不當，可能會導致人員受傷。

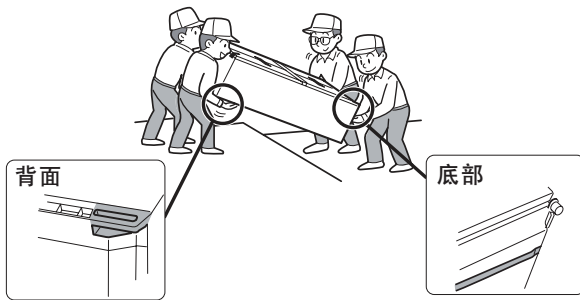

廢舊冰箱的處理

- 確保冰箱在等候處理的過程中不會給兒童帶來危險。（例如拆除門環以防兒童不慎卡入。）
- 請妥善處理冰箱。冰箱請運送至專業的可燃性製冷劑及絕熱發泡氣體廢料處理廠。

使用中

- 由於壓縮機單元或者其外圍部件在操作過程中將變得非常燙手，千萬不要去觸摸，否則，將會被金屬邊緣燙傷。
- 不要用濕手去觸摸冷凍室內的食品 and 金屬製容器。恐會導致手凍傷。
- 請勿將瓶裝或罐裝飲料放入冷凍室。特別是“快速製冷”功能開啓時，玻璃瓶極可能會爆裂。
- 當其他人的手靠近冰箱門時，請勿打開或關閉冰箱門，否則冰箱門會夾到其他人的手。
- 請勿在冰箱門的冰箱盒上放置尺寸過大的物品。如果該物品從冰箱盒上掉落，可能會導致人員受傷。

1 冰箱的周圍應確保足夠的通風空間。

- 圖中顯示出安裝冰箱所需要的最低限度的空間。耗電量的測試需在不同空間條件下進行。
- 冰箱周圍的空間越大，冰箱運行時的耗電量越小。
- 若在小於以下圖所示尺寸的空間內使用冰箱，可能會導致裝置溫度升高，噪音加大和其他故障。
- 冰箱後部與牆體之間的空間距離應為大於 60 毫米且小於 75 毫米。若此空間大於 75 毫米，切勿觸摸在運行中過熱的壓縮機以及外圍部件，以免受傷。

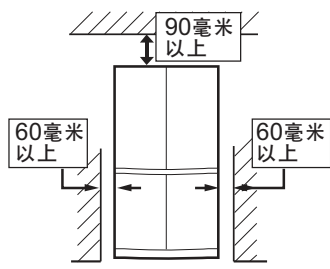

4 卸下冰箱櫃體下部的 4 顆螺絲，然後用這些螺絲安裝設置腳蓋。(腳蓋附在冷藏室中。)

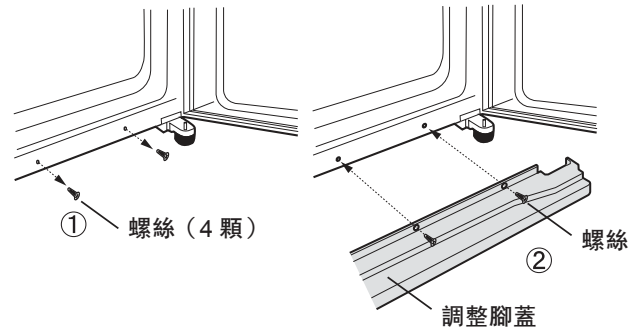

使用時所需總體空間

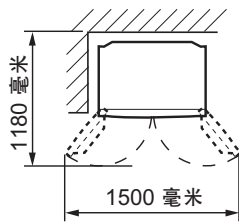

2 請利用前面的兩個調整腳，將冰箱穩妥地安裝在地板的水平位置上。

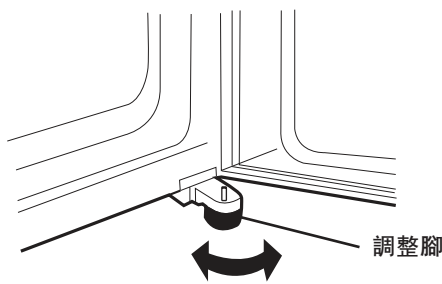

3 當左右門沒有完全對準時通過調整腳來調整。

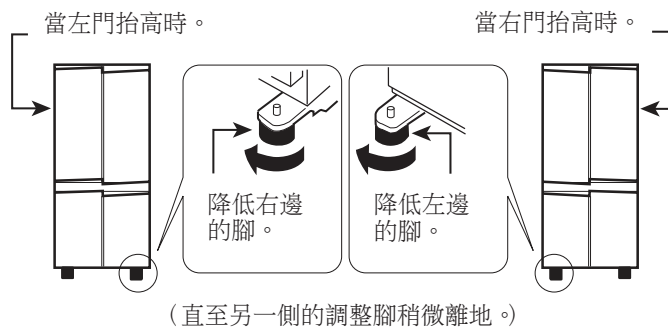

請注意

- 設置冰箱時要充分考慮便於插拔插銷。
- 請勿將冰箱放在陽光直射的地方或發熱機器的旁邊。
- 請勿將冰箱直接放在地面上。請在冰箱下面準備適當的台座，如木板。
- 在打開冰箱門的狀態下插入電源插銷時，會有冰箱門報警鳴響，但是這不屬於異常。關上冰箱門後報警就會停止。

在使用冰箱前

用溫水浸泡過的軟布清潔冰箱內部。如果使用肥皂液，請用水徹底擦掉殘留肥皂液。

各部位名稱

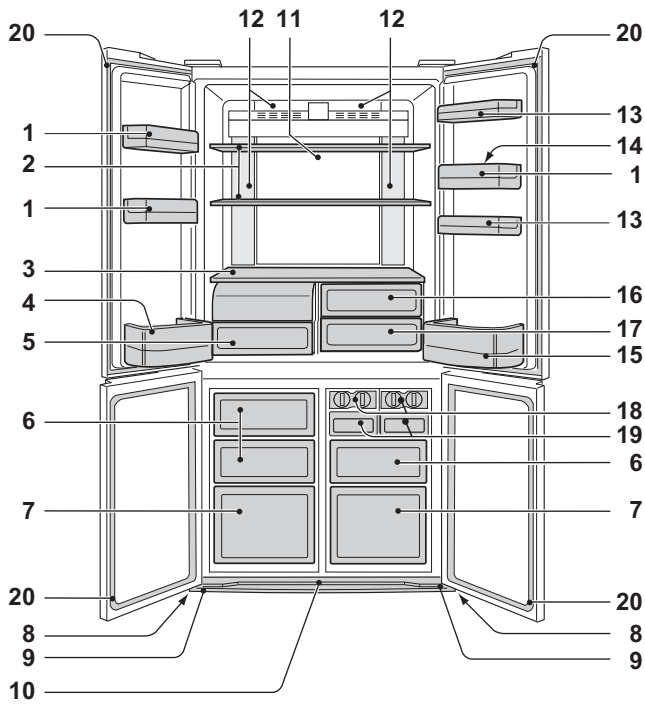

SJ-F95VM/ SJ-FTF24AVP/SJ-VX79E

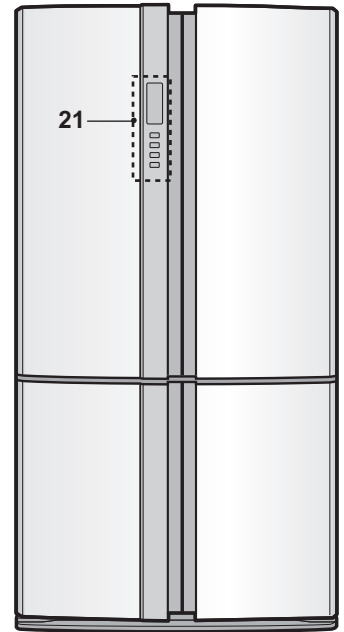
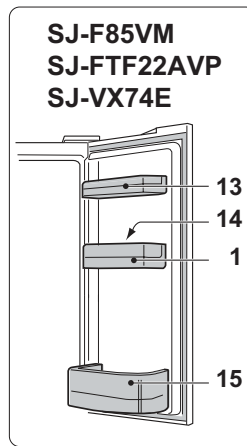

1. 門盒 (3 個)
2. 冷藏室盤架 (2 個)
3. 盤架
4. 瓶盒 (左)
5. 水果和蔬菜保鮮室

當拉出此盒時，則水果和蔬菜保鮮室蓋打開。

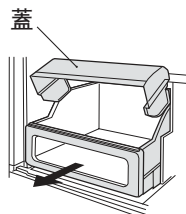

6. 冷凍盒 (小) (3 個)
7. 冷凍盒 (大) (2 個)
8. 移動車輪 (4 個)

移動車輪使冰箱可以前後移動。



9. 調整腳 (2 個)
10. 調整腳蓋

移動車輪

11. 混合冷卻面板

本面板從後部間接地使冰箱冷藏室變涼。這是一種冷藏食品的溫和方法，不會使食品暴露在冷氣流之中。

12. 箱內燈
13. 小物品架

(SJ-F95VM、SJ-FTF24AVP、SJ-VX79E : 2 個)
(SJ-F85VM、SJ-FTF22AVP、SJ-VX74E : 1 個)

14. 蛋架
15. 瓶盒 (右)

欲存放較大瓶子時，請將隔離物往後移。

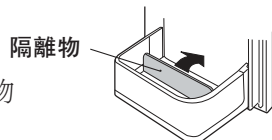

16. 保鮮盒 (上)
17. 保鮮盒 (下)

18. 旋轉式雙製冰盒 (2 個)

- 1) 請勿將過量的水放入製冰盒內。否則，製成的冰會連結在一起。
- 2) 冰製成以後，請按順時針方向轉動控制桿，將冰倒進儲冰盒內。

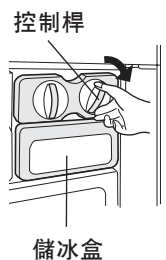

19. 儲冰盒 (2 個)

請注意

請勿用儲冰盒製冰或放入油脂類。儲冰盒有時會因之而碎裂。

20. 門環 (4 個)
21. 控制面板

脫臭裝置

已經將脫臭觸媒設置在冷氣的通道上。不需要進行操作和清潔。

取出內部配件後，可以儲存和適當冷卻更多的食品。

如何取下水果和蔬菜保鮮室蓋

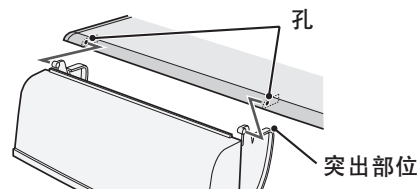

取出的方法

欲拆下隔離物，推動爪狀物將隔離物向前拉。

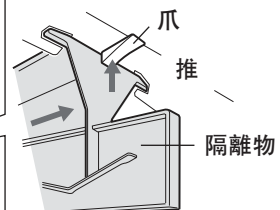

裝上的方法

將四個突出部分插入上部。

- ◻ 強力製冷
- ✻ 快速冷凍
- ✻ 快速製冷

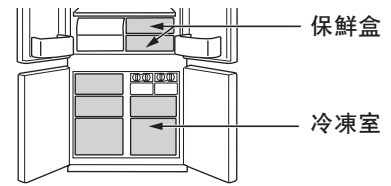

	強力製冷	快速冷凍	快速製冷
特點	可以用本功能將飲料或食品冷凍至冰冷狀態。請注意：含水分高的食品可能會凍結。	可以用本功能加速冷凍食品。	本模式旨在快速冷卻飲料或食品。
應用位置	保鮮盒	冷凍室	冷凍室 安全注意事項：請勿放置玻璃瓶。玻璃瓶極可能會爆裂。
運行時間	6 小時 *1	2 小時 *1	30 分鐘
	<ul style="list-style-type: none"> ·本功能會自動結束。 ·警報器不會響起。 	<ul style="list-style-type: none"> ·本功能會自動結束。 ·警報器響起。 	<ul style="list-style-type: none"> ·本功能會自動結束。 ·警報器響起。
運行結束後	<ul style="list-style-type: none"> ·無需將飲料或食品取出。 		<ul style="list-style-type: none"> ·報警器響起時，請務必取出飲料和食品。 ·如果將飲料或食品放置在冷凍室超過大概 30 分鐘，飲料或食品可能會結冰。
若在操作期間發生斷電	<ul style="list-style-type: none"> ·本功能會自動取消 		<ul style="list-style-type: none"> ·電源恢復後，本功能會自動重新啓動，恢復到之前的狀態。

- *1 當本功能與除霜功能重迭時，可能會更費時。因為本功能要在除霜之後啓動。
- *2 如果不關閉該警報器，警報器將持續響 30 分鐘。

請注意

- 當強力製冷、快速冷凍和快速製冷其中一個功能正在運行時，另外的功能無法同時運行。
- 當這些功能運行之時，盡量避免開門。

淨離子群 (限於 SJ-F85VM, SJ-F95VM, SJ-FTF22AVP, SJ-FTF24AVP)

如果想讓冰箱內部保持潔淨，請使用本功能。

冰箱內的離子產生器將向冷藏室釋放出淨離子群。淨離子群是正離子和負離子的集合體。淨離子群能不活潑空氣中浮遊黴菌。

請注意

- 冰箱內可能有異味。這是離子發生器產生的臭氧的味道。臭氧密度非常小，釋放到冰箱內的臭氧會迅速分解。

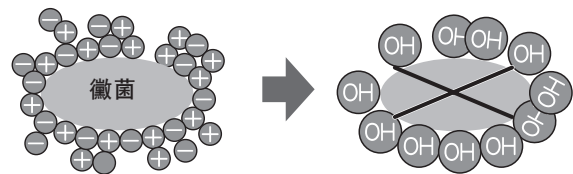

控制面板

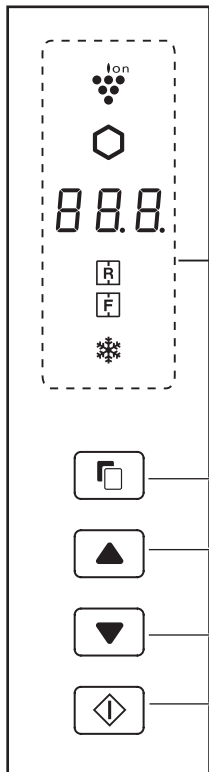

選擇按鈕

切換按鈕

鍵入按鈕

實用功能

圖標	含義	默認設置
	淨離子群 *1	關閉
	強力製冷	
	快速冷凍 快速製冷	

溫度調節

圖標	含義	默認設置
	冷藏室	3°C
	冷凍室	-18°C

附加功能

指示器	含義	默認設置
	門報警器	開
	按鍵操作音	

請注意

- 按下其中一個按鈕時，所有圖標均閃爍一次，然後顯示待機模式。如果冰箱因為斷電停止運行，在電源恢復後，除強力製冷和快速冷凍外的其他功能都將按照斷電前的狀態運行。
- 當冷藏室的門打開時，操作無效。
- 運行中的模式圖標或指示器會在待機顯示器上亮起。運行快速製冷功能時，相應的圖標會在待機顯示器上閃爍。

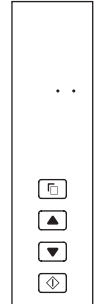

通電狀態

- 如果大約 1 分鐘內無任何操作，顯示器將自動返回至待機狀態。如果再過 1 分鐘仍無任何操作，待機顯示器將關閉。

*1 限於 SJ-F85VM, SJ-F95VM, SJ-FTF22AVP, SJ-FTF24AVP

實用功能的操作

		顯示	
1	選擇功能圖標。		(例：強力製冷) 閃爍
2	選擇“ON”(開)/“OFF”(關)		 “OFF”(關)
3	完成設置。 (嗶) 僅適用於“快速製冷” 持續按下 3 秒鐘或更多， 完成設置。(嗶嗶嗶)		功能圖標亮起。 僅適用於“快速製冷” (閃爍) 待機顯示器的功能圖標熄滅。

按下 按鈕時，圖標會按以下順序轉變。

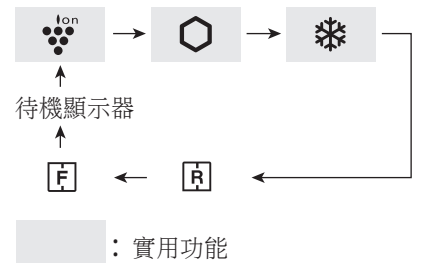

: 實用功能

附加功能的操作

	概要	取消運行	顯示
門報警器	<ul style="list-style-type: none"> · 當冷藏室或冷凍室門沒有關閉時，門報警器將會在開門 · 1 分鐘後響起，並過 1 分鐘後再次響起。 · 如果門保持開啓狀態約 3 分鐘，報警器將會連續響起。 · 所有門關閉後，警報將停止。 	同時按下 按鈕和 按鈕並持續 3 秒鐘或更多。 (嗶嗶嗶)	指示器關閉。
按鍵操作音	<ul style="list-style-type: none"> · 當需要關閉按鍵操作音時。 	同時按下 按鈕和 按鈕並持續 3 秒鐘或更多。 (嗶嗶嗶)	指示器關閉。

請注意 · 當需要啓動附加功能時，請再次遵循相同步驟進行操作。(指示器開啓)

食品的儲存

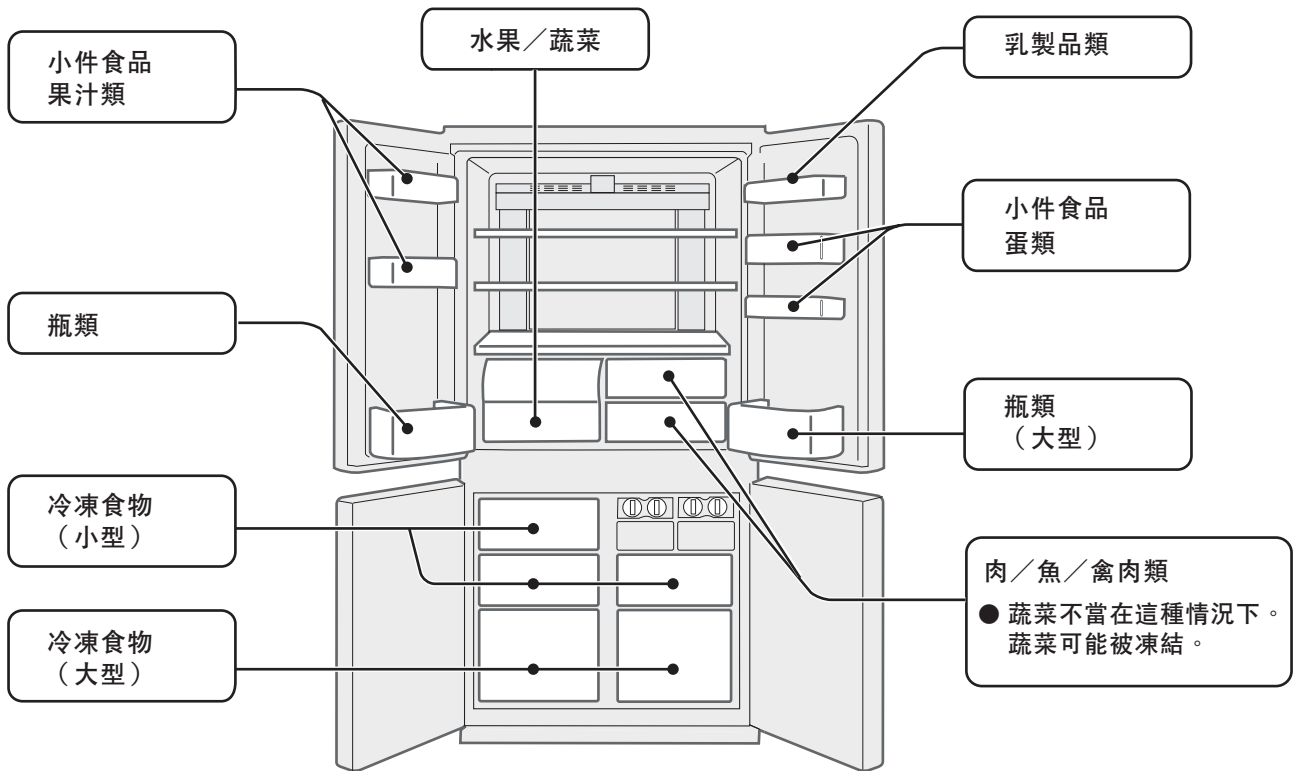

將食品冷藏起來時，食品腐爛的速度就會減緩。要延長易於腐爛食品的保存期限，就應當盡可能選擇較新鮮的食品。下面為延長食品保存期限的簡要介紹，可供您參考。

水果／蔬菜

為盡量減少水份的流失，水果和蔬菜要用保鮮紙及袋子（不封口）之類的塑膠袋輕輕包上，並將其放入蔬果保鮮室或水果盒內。

乳製品和雞蛋

- 幾乎所有乳製品的外包裝上都標有適當的保存溫度和保存期限。
- 請用箱內的蛋架保存雞蛋。

肉類／魚／禽肉

- 請將其放在容器上，並包上保鮮膜。
- 若是大塊的肉、魚和禽肉，請將其放在盤架的內側。
- 已經煮熟的食品務須用保鮮膜包好，或將其放在密封容器內。

為達到最佳冷凍效果

- 食品質量應當新鮮。
- 若要快速冷凍食品，每次都必須少量放入。
- 食品應進行恰當密封，要封緊或蓋緊。
- 將食品均勻地放入冷凍室。
- 袋子和容器上要標上標示，並寫清楚冷凍食品的內容。

防止冰箱內部結水珠或結霜的建議

- 請妥善關好冰箱門。如果冰箱內的食品掉落，可能會導致冰箱櫃體和門之間形成縫隙。請將食品放回冰箱內的盤架或冰箱盒。
- 高水分食品應放在密封容器內保存或密封保存。

請注意

- 為使冷氣充分循環，請將食品均勻地放在盤架上。
- 請將較熱的食品涼下來以後，才保存起來。如果將較熱的食品放進冰箱，冰箱內的溫度會升高，這樣往往很容易導致食品腐爛變質。
- 請勿讓食品和容器擋住使冷氣循環的出風口和吸入口。否則，食品就不能均勻地冷卻。

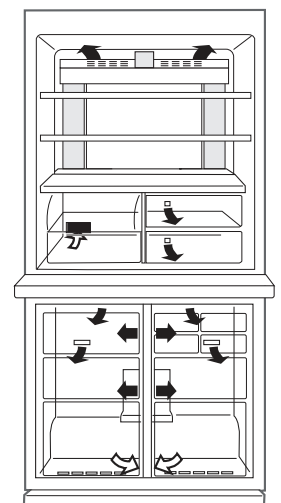

請勿直接將食品放在冷氣出風口旁。這樣會引致食品凍結。

保養

重要提示

為防止冰箱內板表面和塑膠部件發生開裂，請遵從如下操作提示。

- 食用油沾上塑料部件時，請將之擦掉。
- 某些家用化學洗滌劑可能會導致冰箱損傷，因而只能使用稀釋過的廚房用洗滌劑（肥皂水）。
- 如果使用未稀釋的洗劑或者未徹底擦淨肥皂水，則有可能損壞冰箱的塑料部件。

清潔

- 拆下冰箱櫃體或門上的附件，如盤架。用溫水和廚房用洗滌劑清洗，然後，用水洗清並使之乾透。（只有水果和蔬菜盤架不是可動式的）
- 冰箱內部要用浸泡在廚房用洗滌劑的溫水裡的布塊擦洗。然後，用冷水將肥皂水徹底擦乾淨。
- 冰箱的外殼沾上污漬時，請用柔軟的布塊擦洗。
- 冰箱門環要用廚房用洗滌劑的溫水和牙刷洗淨。
- 請用乾布擦拭控制面板。

請注意

- 請勿使用強力清潔劑或溶劑（油漆、塗料、拋光粉、汽油、沸水等），否則可能導致冰箱損傷。
- 一旦拔出電源插頭，請等待至少 5 分鐘之後再重新接通電源。
- 一塊玻璃盤架約重 3kg。從箱內抽出或搬運時請小心托牢。
- 在冰箱內請勿使物體掉落，或用物體強烈碰撞內壁。否則可能導致內壁破裂。

搬運之前

擦拭乾淨蒸發盤裡的水。擦乾之前，拔出電源插頭之後，請務必等待 1 小時以上，因為製冷循環設備是非常熱的。（蒸發盤位於產品的背面。）

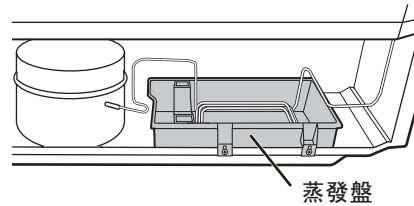

切斷冰箱的電源時

如需將冰箱長時間關閉，應遵循以下步驟以減少霉菌增長：

1. 將食物全部取出。
2. 將電源插頭從插座中拔出。
3. 將內部徹底清潔並乾燥。
4. 將全部的門稍微開啓數天進行乾燥。

除霜

本冰箱透過獨特的節約能源系統，完全實現自動除霜。

當冷藏室內燈損壞時

請聯繫 SHARP 認可的售後服務中心更換內燈。非專業服務人員不得更換內燈。

節約能量的竅門

- 冰箱周圍應儘量確保足夠的通風空間。
- 請勿將冰箱放在陽光直射的地方或發熱機器的旁邊。
- 盡量避免開門。
- 請將較熱的食物涼下來以後才保存起來。
- 為使冷氣充分循環，請將食品均勻地放在盤架上。

耗電量

此模式下的耗電量是根據冰箱性能的國際標準測量而得。如果取出這些附件（陰影區域）後運行冰箱，冰箱將在最節能的條件下工作。

- 此模式的耗電量是在如陰影區域圖所示取下附件後測量而得。

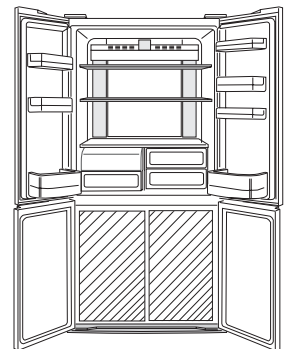

- 此模式下的耗電量是在右圖所示的空間尺寸下測量而得。

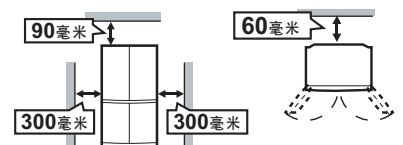

送修之前的初步檢查

送修之前，請對下列地方進行檢查。

問題	對策
冰箱外箱有時會變熱。	這並非異常。防止結露的熱導管裝在機身的內部。
冰箱發出噪聲時。	冰箱如發出下述聲音，這並非異常。 <ul style="list-style-type: none">· 運轉開始時，壓縮機發出較大的噪音<ul style="list-style-type: none">— — — 不久聲音會變小。· 壓縮機每日一次發出較大噪音<ul style="list-style-type: none">— — — 緊隨自動除霜操作之後發出的運轉聲。· 液體流動的聲音（咕嚕聲、嘶嘶聲）<ul style="list-style-type: none">— — — 冷媒在管道內流動的聲音（聲音時而會變得較大）。· 劈啪聲或吱嘎聲，吱吱聲<ul style="list-style-type: none">— — — 冷卻時內壁和內部零件膨脹和收縮的聲音。
冰箱內部和冰箱外側結霜或結露。	在下列情形下有可能發生這種現象。請用濕布擦掉霜，用乾布擦掉露珠。 <ul style="list-style-type: none">· 周圍溫度較高時。· 頻繁開啓冰箱門時。· 冰箱內存放水分較多的食品時。（請用保鮮膜包上）
冷藏室的食品結凍。	<ul style="list-style-type: none">· 是否長期冷藏室溫度調節為 0°C 下使用冰箱？<ul style="list-style-type: none">— — — 將溫度調節調回 3°C 左右。· 是否長期冷凍室溫度調節為 -21°C 下使用冰箱？<ul style="list-style-type: none">— — — 將溫度調節調回 -18°C 左右。· 在環境溫度較低時，即使將冷藏室溫度調節控制到 6°C，食品有時也會被凍結。
冰箱內部有異味。	<ul style="list-style-type: none">· 請將氣味較強的食品用保鮮紙包起來。· 脫臭裝置不能去掉所有異味。
如果門警報器不停止發出警報。	<ul style="list-style-type: none">· 門關閉後，警報將停止。

經檢查後仍需要送修時

請與就近的 SHARP 認可的售後服務中心洽詢。

SHARP

SHARP CORPORATION