

# SHARP



Refrigerant: R600a

Insulation blowing gas: Cyclopentane

製冷劑：R600a

絕熱發泡氣體：環戊烷

## Refrigerator - Freezer Operation manual

原裝進口電冰箱  
使用說明書

SJ-P498G-K	SJ-E438M-S
SJ-P498G-M	SJ-E438M-K
SJ-P598G-K	SJ-E538M-S
SJ-P598G-M	SJ-E538M-K
SJ-PG35P-BK	
SJ-PG35P-BR	
SJ-PG39P-BK	
SJ-PG39P-BR	
SJ-FTG15BVP-BK	
SJ-FTG15BVP-BR	

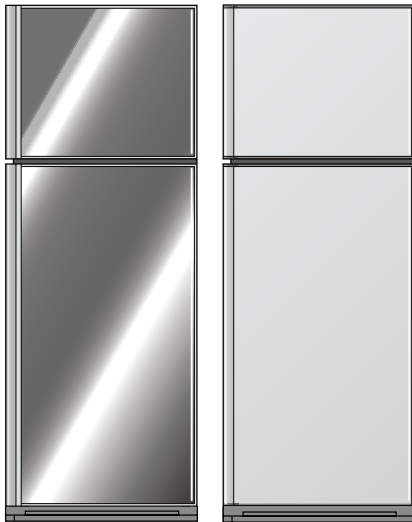

SJ-P498G  
SJ-P598G  
SJ-PG35P  
SJ-PG39P  
SJ-FTG15BVP

SJ-E438M  
SJ-E538M



(Only for SJ-P498G, SJ-P598G, SJ-PG35P, SJ-PG39P, SJ-FTG15BVP)  
“Plasmacluster” and “Device of a cluster of grapes” are trademarks of Sharp Corporation.

## Contents

- Safety information . . . . . 3
- Installation . . . . . 5
- Description . . . . . 6
- Useful modes . . . . . 7
- Control panel . . . . . 8
- Storing food . . . . . 10
- Care and cleaning . . . . . 11
- Before you call for service . . . . . 12

## 目錄

- 安全注意事項 . . . . . 13
- 安裝 . . . . . 15
- 各部位名稱 . . . . . 16
- 實用功能 . . . . . 17
- 控制面板 . . . . . 18
- 食品的儲存 . . . . . 20
- 保養 . . . . . 21
- 送修之前的初步檢查 . . . . . 22



Thank you very much for buying this SHARP product. Before using your SHARP refrigerator, please read this operation manual to ensure that you gain the maximum benefit from it.

- This refrigerator is intended for making ice cubes, refrigerating and freezing food.
- This refrigerator is for household use only, with ambient temperature indicated in the table. The climate class is specified on the rating plate. If the refrigerator operates out of range (ambient temperature range) of the climate class which is rated for that model, it may not be able to maintain satisfactory internal temperatures. If the refrigerator is used at colder temperatures, the refrigerator will not be damaged up to a temperature of +5°C.
- The refrigerator should not be subjected to temperatures of -10°C or below for a long period of time.

Household use only	
Climate class	Acceptable range of ambient temperature
SN	+10°C to 32°C
N	+16°C to 32°C
ST	+16°C to 38°C
T	+16°C to 43°C

## Safety information

 **WARNING** This means that there are high risks of death or serious injury.

 **CAUTION** This means that there are high risks of material damage or personal injury.

### **WARNING**

#### Refrigerant

This refrigerator contains flammable refrigerant (R600a: isobutane) and insulation blowing gas (cyclopentane). Observe the following rules to prevent ignition and explosion.

- Do not allow any pointed objects to have contact with the refrigeration system. The refrigeration system behind and inside the refrigerator contains refrigerant.
- Do not use mechanical devices or other means to accelerate the defrosting process. (This refrigerator has adopted automatic defrosting system.)
- Do not use electrical appliances inside the refrigerator.
- Do not block the space around the refrigerator.
- Do not use flammable sprays, such as spray paint near the refrigerator.
- Do not store flammable sprays, such as spray paint in the refrigerator.
- In the case of failure of the refrigeration system, do not touch the wall socket and use open flames. Open the window and let out the air from the room. Then ask a service agent approved by SHARP for service.

#### Installation

- Do not install the refrigerator in a damp or wet location. It may cause the damage to the insulation or electrical leak. Dew may also appear on the outer cabinet and it causes rust.
- The refrigerator should be installed flatly and firmly on the floor.

#### Power cord, Plug, Socket

Read carefully the following rules to prevent electric shock or fire.

- Connect the power plug into the wall socket firmly and directly. Do not use an extension cord or adapter plug.
- Connect the power plug to the socket with the required rated voltage.
- Connect the earth pin to the earth terminal properly. (3 pin plug region)
- Connect the earth wire which is installed at the rear of the product to the earth terminal properly. (2 pin plug region)

- Make sure to protect the power cord from being damaged during installation or moving. If the power plug or cord is loose, do not insert the power plug.
- Do not touch the power plug with wet hands.
- Disconnect from the main electricity supply by removing the main plug from the socket. Do not remove by pulling the power cord.
- Dust deposited on the power plug may cause fire. Wipe it off carefully.
- Pull out the plug if the refrigerator is not used for a long time.
- If the flexible supply cord is damaged, it must be replaced by service agent approved by SHARP because special cord is required.

#### In use

- Do not store volatile and flammable materials such as ether, petrol, propane gas, aerosol cans, adhesive agents and pure alcohol etc. These materials are easy to explode.
- Do not store temperature-sensitive products such as pharmaceutical products in the refrigerator. There are high risks of changes in product quality.
- Do not attempt to change or modify this refrigerator. This may result in fire, electric shock or injury.
- Do not place any object on the top of refrigerator. If the object falls down from the top, it may cause injury.
- Do not hit the glass doors hard. Otherwise, they may break and cause physical injury.  
<Only for SJ-P498G, SJ-P598G, SJ-PG35P, SJ-PG39P, SJ-FTG15BVP>
- This appliance can be used by children aged from 8 years or above and persons with reduced physical, sensory or mental capabilities or lack of experience and knowledge if they have been given supervision or instruction concerning use of the appliance in a safe way or understanding the hazards involved. Children shall not play with the appliance. Cleaning and user maintenance shall not be done by children without supervision.

# Safety information

## Care and Cleaning

- Unplug the refrigerator first to prevent electric shock.
- Do not splash water directly on the outer cabinet or the interior. This may lead to rusting and deterioration of the electrical insulation.

## Trouble

- If you smell something burning, pull out the power plug immediately. Then ask a service agent approved by SHARP for service.
- In case of gas leak, ventilate the area by opening window. Do not touch the refrigerator or the power socket.

## Disposal

- Ensure that the refrigerator presents no danger to children while being stored until disposal. (e.g. remove the door to prevent child entrapment.)
- This refrigerator should be disposed appropriately. Take the refrigerator to a professional recycling plant for flammable refrigerant and insulation blowing gases.

## CAUTION

### Transportation

- When you install or move your refrigerator, use curing mat to protect the floor from being damaged.
- Carry the refrigerator by holding the handles located on the rear and the feet of the bottom. If you lift up the refrigerator improperly, it may cause injury.

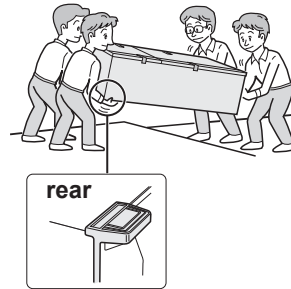

### In use

- Do not touch the compressor unit or its peripheral parts, as they become extremely hot during operation and the metal edges may cause injury.
- Do not touch foods or metal containers in the freezer compartment with wet hands. This may cause frostbite.
- Do not place bottled drinks and cans in the freezer compartment. Especially "Express cool" is in operation, there is a high risk that glass bottles may burst.
- Do not use other than potable water to make ice cubes.
- Do not open or close the door when somebody put a hand near the door. There is a risk that the other people may catch their fingers in the door.
- Do not put oversized object in the pockets of the door. If the object falls down from the pockets, it may cause injury.
- Make sure to handle the glass shelves with care to install or uninstall. If you drop the glass shelves, it may break or cause injury.

- 1** Keep adequate ventilation space around the refrigerator.
- The picture shows the minimum required space for installing the refrigerator. The measurement condition of energy consumption is conducted under a different space dimension.
  - By keeping greater space, the refrigerator may consume a less amount of power consumption.
  - If use the refrigerator in the smaller space dimension than pictured below, it may cause temperature rise in the unit, loud noise and failure.
  - The space between the rear of the refrigerator and the wall should be 50mm or more, and less than 75mm. If the space is wider than 75mm, you may get injured by touching compressor and its peripheral parts which are extremely hot during the operation.

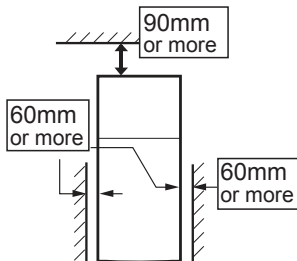

- 3** Remove the 2 screws of the lower part of the cabinet and use these screws to set the foot cover. (The foot cover is packed inside the refrigerator compartment.)

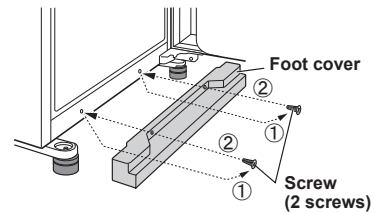

- 4** Connect the appliance via a correctly installed socket.

**Note**

- Place your refrigerator to access the plug.
- Keep your refrigerator out of direct sunlight and do not place next to heat generating appliance.
- Do not place your refrigerator directly on the ground. Insert suitable stand such as wooden board under the refrigerator.
- When you insert the power plug with the door opened, door alarm sounds but it is normal. This sound stops after closing the door.

Overall space required in use

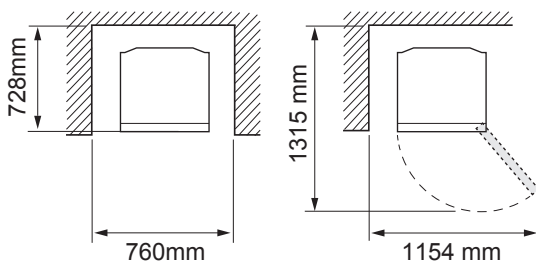

**Casters are located on the bottom of the refrigerator**

- The casters allow the refrigerator to move back and forth.



**Casters**

SJ-P498G, SJ-E438M, SJ-PG35P: 2pcs.  
SJ-P598G, SJ-E538M, SJ-PG39P, SJ-FTG15BVP: 4pcs.

- 2** Use the two front adjustable feet to place the refrigerator flatly and firmly on the floor.

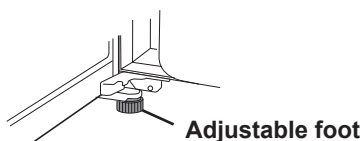

**Before using your refrigerator**

- Clean the inside parts with a cloth soaked in warm water.
- If you use soapy water to clean, wipe it off thoroughly with water.

# Description

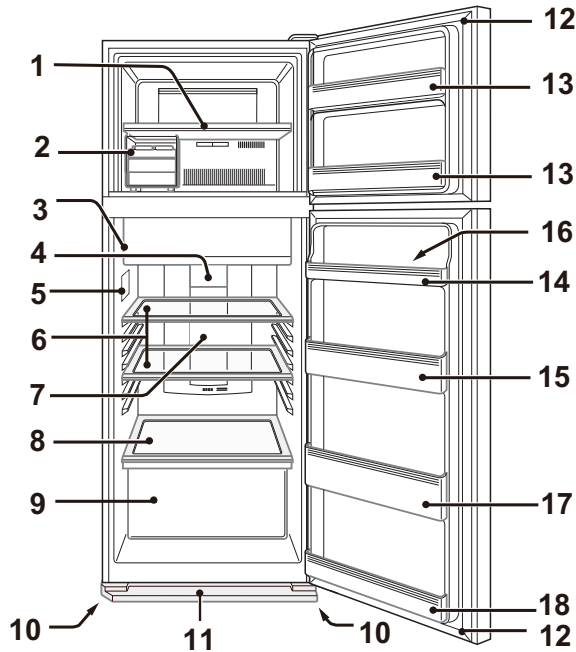

## 1. Freezer shelf

## 2. Movable ice maker

It is highly recommended to use this ice maker as shown in the above picture.

You can put the ice maker anywhere in the freezer compartment.

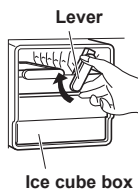

- 1) Do not overfill the tray with water. Otherwise the ice cubes will join together when frozen.
- 2) When ice cubes are made, turn the lever clockwise to put the ice into the ice cube box.

### Note

- Make sure to place the ice maker flatly not to spill out the water from the ice tray.
- To prevent the ice cube box from being damaged, do not pour oil into it or make ice in it.

## 3. Fresh case & door

## 4. Refrigerator light

## 5. Control panel

## 6. Refrigerator shelves(2 pcs)

## 7. Hybrid cooling panel

The panel cools the refrigerator compartment indirectly from the rear. In this way, food is cooled gently without being exposed to cold air flow.

## 8. Fruit and vegetable shelf

## 9. Fruit and vegetable crisper

## 10. Adjustable foot (2 pcs)

## 11. Foot cover

## 12. Magnetic door seal (2 pcs)

## 13. Freezer door pocket (2 pcs)

## 14. Egg pocket

SJ-P598G, SJ-E538M, SJ-PG39P, SJ-FTG15BVP : 1 pc  
 SJ-P498G, SJ-E498M, SJ-PG35P : 2 pcs

SJ-P498G, SJ-E438M, SJ-PG35P

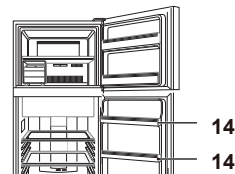

## 15. Refrigerator pocket (Upper)

(Only for SJ-P598G, SJ-E538M, SJ-PG39P, SJ-FTG15BVP)

## 16. Egg holder

## 17. Bottle pocket

## 18. Refrigerator pocket (Bottom)

## If you wish to store large items within your refrigerator

- You may remove any shelves or any pockets numbered 1,2,3,6,9 in the picture above.
- Cooling performance is not influenced even if you use the refrigerator in the above situation.

## Deodorizing unit

Deodorizing catalyst is installed on the routes of cold air. There is no need to operate and clean.

# Useful modes

As for the operations, refer to chapter "Control panel".



**Extra cool**



**Express freezing**



**Express cool**

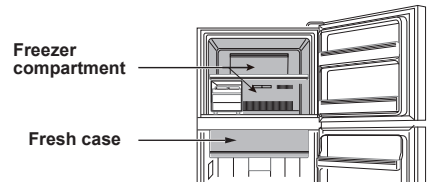

	Extra cool	Express freezing	Express cool
Feature	This mode is to cool beverages or foods to ice-cold. <b>Note</b> : Food with high-moisture may freeze.	This mode speeds up the time to freeze food.	This mode is to cool beverages or foods quickly.
Point of use	Fresh case	Freezer compartment	Freezer compartment <b>CAUTION</b> : Do not place glass bottles. There is a high risk that they may burst.
Operating time	6 hours *1 • This mode ends automatically. • The alarm does not sound.	2 hours *1	30 minutes • This mode ends automatically. • The alarm sounds. <b>To stop the alarm *2</b> Press "Express freezing" button.
After the operation completed	• There is no need for taking beverages or foods out.		• Be sure to take the beverages and foods out when the alarm sounds. • If the beverages and foods are left in the freezer compartment over approximately 30 minutes, they may freeze.
At the time of power failure during the operation	• This mode is automatically cancelled.		• This mode is automatically restarted from the previous state at the time of re-power.

ENGLISH

## Note

- Extra cool, Express freezing and Express cool are not available at the same time while one of the modes is in operation.
- Avoid opening the door as much as possible during the operations of these modes.

\*1 It may take more time to complete if the operation overlaps with defrosting. This mode starts after defrosting is completed.

\*2 If you do not stop the alarm, it sounds 30 minutes continuously.

## Ion Plasmacluster

(Only for SJ-P498G, SJ-P598G, SJ-PG35P, SJ-PG39P, SJ-FTG15BVP)

The Plasmacluster automatically starts operating when the refrigerator is powered on.

The ionizer inside your refrigerator releases clusters of ions, which are collective masses of positive and negative ions, into the refrigerator compartment. These ion clusters inactivate airborne mold fungus.

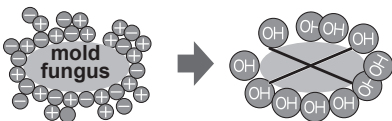

## Note

- There may be a slight odor in the refrigerator. This is the smell of ozone generated by the ionizer. The amount of ozone is minimum and quickly disappears in the refrigerator.

# Control panel

## Useful modes

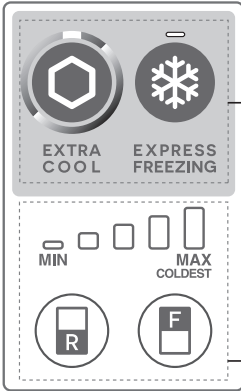

Button	Meaning	Default setting
	Extra cool	OFF
	Express freezing	
	Express cool	

## Controlling temperature

Button	Meaning	Default setting
	Controlling temperature of Refrigerator compartment	
	Controlling temperature of Freezer compartment	

### Note

- If you want to light up the indicator, press "F" or "R" button.

## Operations of useful modes

	Start operation	Cancel operation
<b>Extra cool</b>	Press the mode button. (Beep) 	Press the mode button. (Beep) 
<b>Express freezing</b>	Press the mode button. (Beep) 	Press the mode button. (Beep) 
<b>Express cool</b>	Press the mode button for 3 seconds or more. (Beep, beep, beep) 	Press the mode button. (Beep) 

## Door Alarm

- When the refrigerator door is left open for over 1 minute, door alarm sounds once, and again after 1 minute.
- If the door is left open for approx. 3 minutes, the alarm sounds continuously.
- The alarm stops after closing the door.

### If the door alarm does not stop

If the door alarm does not stop after closing all doors, it is a defect. Contact the SHARP service center for service.

### Method of stopping the door alarm temporarily

- Press "R" button and "F" button simultaneously and continuously for 3 seconds or more.
- The door alarm sounds again after approximately 2 days.





# Controlling temperature

The refrigerator controls its temperature automatically. However, you can adjust the temperature as below.

## How to check the current temperature setting

The indicator lights up to show the current temperature level by pressing "F" or "R" button.

Freezer compartment : Press "F" button.

Refrigerator compartment : Press "R" button.

## Setting of Freezer/Refrigerator compartment

### Freezer compartment

1. Press "F" button.

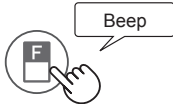

2. Press "F" button to change the temperature level.

### Refrigerator compartment

1. Press "R" button.



2. Press "R" button to change the temperature level.

- Temperature indicator changes as the picture below (3→4→5→1→2→3) by pressing "F" or "R" button.

Level	Indicator
1	
2	
3	Default setting 
4	
5	

### Note

- After adjusting the temperature level, the indicator turns off approximately 5 seconds later.
- The temperature setting remains the same even after power failure.

## Advanced Setting of Freezer/Refrigerator compartment

The temperature of refrigerator compartment and freezer compartment can be adjusted in 9 levels (level 1 ~ 9) by following the steps **a** to **b**.

### Freezer compartment

- a. Press "F" button first. Hold down "F" button and then press "Express freezing" button for 3 seconds or more.



The indicator returns to "Default setting".

- b. Press "F" button to change the temperature level.

Follow the steps **a** to **b** if you want to adjust the temperature in 5 levels.

### Refrigerator compartment

- a. Press "R" button first. Hold down "R" button and then press "Express freezing" button for 3 seconds or more.



The indicator returns to "Default setting".

- b. Press "R" button to change the temperature level.

Follow the steps **a** to **b** if you want to adjust the temperature in 5 levels.

- Temperature indicator changes as the picture below (5→6→7→8→9→1→2→3→4→5) by pressing "F" or "R" button.

○ ... OFF    ■ ... Lighting    }= } ... Flashing

Level	Indicator
1	
2	
3	
4	
5	Default setting 
6	
7	
8	
9	

# Storing food

- Ensure that the food is of the freshest possible quality to maximize the storage life of perishable food. The following is a general guide to help promote longer food storage.
- Food has a limited storage life. Make sure not to exceed use-by date indicated by manufacturer.

## Freezer

- Freeze small quantities of food at a time in order to freeze them quickly.
- Food should be properly sealed tightly or covered.
- Place food in the freezer evenly.
- Label bags or containers to keep an inventory of freezing food.

## Refrigerator

### Fruit / Vegetables

- Fruit and vegetables should be loosely enclosed in a plastic material e.g. wrap, bags (do not seal) and placed in the fruit and vegetable crisper to minimize moisture loss.
- Fruits and vegetables which are easily effected by low temperature should be stored in a cool place except for the refrigerator.

### Dairy Products & Eggs

- Most dairy products have their best-before date on the outer packaging which informs the recommended temperature and shelf life of the food.
- Eggs should be stored in the egg holder.

### Meats / Fish / Poultry

- Place on a plate or a dish and cover with paper or plastic wrap.
- For larger cuts of meat, fish, or poultry, place to the rear of the shelves.
- Ensure all cooked food is wrapped securely or placed in an airtight container.
- Fresh food (securely wrapped) should be stored in limited time to prevent spoilage and badly affecting other stored foods.

## Advice for preventing dew or frost inside the refrigerator

- Keep the door securely closed. If the food falls down, it may cause a gap between the cabinet and the door. Move it back to the shelf or the pocket.
- Open and close the door quickly as much as possible. Dew or frost may appear if the door is left open for a long period of time or opening and closing of the door is very often.
- Stored items should be packed or sealed with such as food containers or plastic wraps. (Especially food with high-moisture)

## Advice for storing food

- Evenly place the food on the shelves to allow the cooling air to circulate efficiently.
- Hot food should be cooled before storing. Storing hot food increases the temperature in the unit and the risk of food spoilage.
- Do not block the outlet and inlet of the cool air circulating circuit with food or containers; otherwise the food is not be evenly cooled throughout the refrigerator.
- Do not place food directly in front of cold air outlet. This may lead to the food freezing.

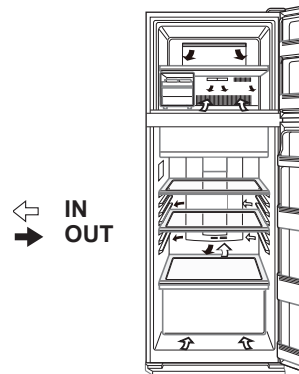

## Tips for saving energy

- Install the refrigerator in a well-ventilated area and keep the space to ventilate.
- Keep your refrigerator out of direct sunlight and do not place it next to heat generating appliance.
- Avoid opening the door as much as possible.
- Hot food should be cooled before storing.
- Place the food evenly on the shelves to allow the cool air to circulate efficiently.

- The amount of energy consumption of this model is measured as shown in the picture below.

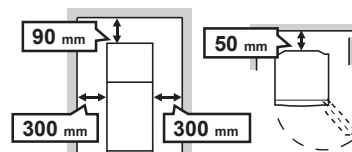

# Care and cleaning

## Important

Follow the tips below to prevent cracks on the inner surfaces and plastic components

- Wipe out food oil adhered to plastic parts.
- Some household chemicals may cause damage, so use only diluted washing-up liquid (soapy water).
- If undiluted detergent is used or soapy water is not wiped off thoroughly, it may result in cracks of plastic parts.

## Cleaning

- Remove the accessories (e.g. shelves) from the cabinet and the door. Wash them by warm soapy dishwashing water. After that, rinse them in clean water and dry. (Only fruit and vegetable shelf is not removable)
- Clean the inside with a cloth soaked in warm soapy dishwashing water. Then, use cold water to wipe off soapy water thoroughly.
- Wipe the exterior with a soft cloth each time it gets dirty.
- Clean the magnetic door seal with a toothbrush and warm soapy dishwashing water.
- Wipe the control panel with a dry cloth.

### Note

- Do not use heavy-duty cleansers or solvents (lacquer, paint, polishing powder, benzine, boiled water, etc.) which may cause damages.
- If you pull out the power plug once, wait 5 minutes at least before connecting the power plug again.
- The glass shelves weigh approximately 2 kg each. Hold them firmly when remove from the cabinet and carry.
- Do not drop objects inside the refrigerator or strike the inner wall. This may cause cracks to inner surface.

## Before transporting

- Wipe up water in the evaporating pan. Before wiping up the water, wait more than 1 hour after pulling out the plug because refrigeration cycle equipment is extremely hot. (The evaporating pan is located on the rear of the product.)

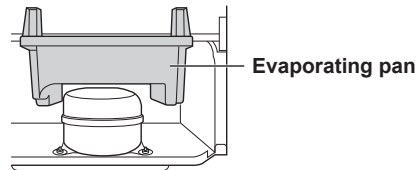

## Defrosting of the cooling unit

- Defrosting is automatically operated by a unique energy saving system. (Approx. once a day.) Ice making takes time because the temperature inside becomes slightly higher than usual during the defrosting.

## When the compartment light is blown

- Contact the service agent approved by SHARP to replace the light. The light is not to be replaced other than by qualified service personnel.

## Switching off your refrigerator

If the refrigerator needs to be switched off for an extended period, the following steps should be taken to reduce the growth of mold

1. Remove all food.
2. Remove the power plug from the socket.
3. Clean and dry the interior thoroughly.
4. Keep all the doors open slightly for a few days to dry.

# Before you call for service

Before calling for service, check the following points.

Problem	Solution
The outside of the cabinet is hot when touched.	It is normal. This is because of the hot pipe in the cabinet in order to prevent dew generation.
Refrigerator makes loud noise.	<p>Following sounds are normal.</p> <ul style="list-style-type: none"> <li>• The compressor makes loud noise when its operation starts -- Sound becomes quieter after a while.</li> <li>• The compressor makes loud noise once a day. -- Operating sound is made immediately after automatic defrost operation of the cooling unit.</li> <li>• Sound of flowing fluid (gurgling sound, fizzing sound) --It is caused by refrigerant flowing in pipes(sound may become louder from time to time).</li> <li>• Cracking or crunching sound, squeaking sound -- It is caused by expansion and construction of inner walls and internal parts during cooling.</li> </ul>
Frost or dew appears inside or outside the refrigerator.	<p>This may occur in one of the following cases. Use a wet cloth for wiping frost and a dry cloth for wiping dew.</p> <ul style="list-style-type: none"> <li>• When the ambient humidity is high.</li> <li>• When the door is frequently opened and closed.</li> <li>• When food containing plenty of moisture are stored. (Wrapping is required.)</li> <li>• This phenomenon will appear more or less depending on the season (rainy season, season), habits of usage and environmental conditions of each house.</li> </ul>
The food in the refrigerator compartment is frozen.	<ul style="list-style-type: none"> <li>• Is the refrigerator operated for a long time with refrigerator temperature control set MAX COLDEST? -- Change the temperature control to the other setting.</li> <li>• Is the refrigerator operated for a long time with freezer temperature control set MAX COLDEST? -- Change the temperature control to the other setting.</li> <li>• If ambient temperature is low, food may freeze even if the refrigerator compartment is set MIN.</li> </ul>
Odors in the compartment.	<ul style="list-style-type: none"> <li>• Wrapping is required for the foods with strong odors.</li> <li>• Deodorizing unit cannot remove all odors.</li> <li>• Clean the inside periodically.</li> </ul>

## If you still require service

Refer to your nearest service agent approved by SHARP.

感謝您購買SHARP 產品。在使用SHARP 電冰箱之前，為使您能夠充份使用您所購買的冰箱，請仔細閱讀本使用說明書。

- 本冰箱可用於製作冰塊、冷藏和冷凍食物。
- 這個冰箱僅限於家庭用途，使用冰箱的環境溫度已在表格中寫明。氣候類型已在標牌上詳細說明。  
如果冰箱的溫度範圍（環境溫度範圍）超出了該型號所評的氣候等級，則可能無法維持滿意的內部溫度。如在較冷的環境溫度下使用本冰箱，則環境溫度需達到+5°C 才能保證不損壞冰箱。
- 冰箱在一段長時間內不應受到-10°C或以下的溫度。

僅限於家庭用途

氣候類型	可接受的環境溫度範圍
SN	+10°C ~ 32°C
N	+16°C ~ 32°C
ST	+16°C ~ 38°C
T	+16°C ~ 43°C

## 安全注意事項

 **警告** 這表明導致死亡或重傷的風險很高。

 **安全注意事項** 這表明導致材料受損或人員受傷的風險很高。

### 警告

#### 冷媒種類

冰箱含有易燃製冷劑（R600a：異丁烷）和絕熱發泡氣體（環戊烷）。

為防止著火和爆炸，請遵守以下規則。

- 請勿讓任何尖狀物體接觸製冷系統。冰箱內部及後側的製冷系統內含有製冷劑。
- 請勿使用機械設備或其他方式來加速除霜過程。（此冰箱已採用自動除霜系統。）
- 請勿在冰箱內使用電器。
- 請勿堵塞冰箱周圍的空間。
- 請勿在冰箱附近使用易燃性噴霧劑，例如噴漆，否則可能會導致爆炸或火災。
- 請勿存放任何易燃噴霧劑，例如在冰箱內噴漆。
- 如果冰箱的冷卻系統出現故障，請勿接觸牆壁電源插座，也勿使用明火。  
開啟窗戶，保持空氣流通。然後聯繫SHARP認可的售後服務中心進行維修。

#### 安裝

- 請勿將冰箱設置在濕氣多及濺得到水的地方。這樣會因絕緣失效而導致漏電。而且有時會在冰箱外側結露。
- 將冰箱穩妥地安裝在地板的水平位置上。

#### 電源線，插頭，插座

為防止觸電或火災，請仔細閱讀以下規則。

- 直接將電源插頭牢牢地插入牆壁電源插座。請勿使用延長的電線或轉換插頭。
- 將電源插頭插入符合額定電壓要求的插座上。
- 正確地將接地棒連接到接地端子。（3 腳插頭地區）
- 連接其安裝在產品的接地端子的後適當的接地線。（2 腳插頭地區）

- 確保在安裝或移動過程中保護電源纜線不受損壞。如果電源插頭或電源線出現鬆動等情況，請勿插入電源插頭。
- 請勿用濕手接觸電源插頭。
- 拔出電源插頭時，請不要只拉住電源線，應該拿住插頭端拔出。
- 電源插頭上積滿灰塵是引起火災的原因。因此，請時常將其擦淨。
- 冰箱如果長時間不使用，請將插頭拔出。
- 因為需要特殊纜線，所以在可彎曲的電源纜線損壞時，必須由 SHARP 批准的服務代理人更換纜線。

#### 使用中

- 請勿儲藏揮發性物質和易燃性物質，如乙醚、汽油、丙烷氣、粘合劑、純乙醇等。此類物質有爆炸之危險。
- 請勿在冰箱內儲存溫度敏感型產品，例如醫藥產品。否則產品極可能會變質。
- 請勿改裝冰箱。  
修理技術人員以外的人員拆卸和修理本機，會導致火災、觸電和受傷。
- 請勿在冰箱頂部放置任何物品。  
如果物品從冰箱頂部掉落，可能會導致人員受傷。
- 請勿用力敲擊玻璃門。否則，玻璃門可能會破碎，導致身體受傷。  
<限於 SJ-P498G, SJ-P598G, SJ-PG35P, SJ-PG39P, SJ-FTG15BVP>
- 此冰箱適合 8 歲及以上的兒童使用。在有符合電器使用安全的監督或指導及了解潛在危險的前提下，此冰箱也適合身體、感官或智力方面有缺陷的殘障人士、或者缺乏相關經驗或知識的人士使用。禁止讓兒童玩耍冰箱。在無任何監督的情況下，兒童不得對冰箱進行清潔及維修保養。

# 安全注意事項

## 保養

- 為了防止觸電，首先拔掉冰箱的電源插頭。
- 請勿直接將水灑在冰箱的內部和外部。這樣會導致生鏽及絕緣性能下降。

## 故障

- 如果您聞到有東西燒焦了，則立即拔出電源插頭。然後聯繫SHARP認可的售後服務中心進行維修。
- 萬一發生瓦斯氣漏事故，請勿用手去觸摸冰箱和插頭，要打開窗戶通風。

## 廢舊冰箱的處理

- 確保冰箱在存放時不會對兒童造成危險，直致丟棄為止。（例如，卸下冰箱門，防止兒童陷入困境。）
- 請妥善處理冰箱。冰箱請運送至專業的可燃性製冷劑及絕熱發泡氣體廢料處理廠。



## 安全注意事項

### 運輸

- 安裝或移動冰箱時，請使用防護墊以防止地板受損。
- 握住位於底部後方與底腳的握把搬動冰箱。如果抬起冰箱的方式不當，可能會導致人員受傷。



### 使用中

- 由於壓縮機單元或者其外圍部件在操作過程中將變得非常燙手，千萬不要去觸摸，否則，將會被金屬邊緣燙傷。
- 不要用濕手去觸摸冷凍室內的食品 and 金屬製容器。恐會導致手凍傷。
- 請勿將瓶裝或罐裝飲料放入冷凍室。特別是“快速製冷”功能開啟時，玻璃瓶極可能會爆裂。
- 請勿用飲用水以外的水製作冰塊。
- 在有人將手放在冰箱門附近時，請勿開關門。存在其他人可能會被冰箱門夾住手指的風險。
- 請勿在冰箱門的冰箱盒上放置尺寸過大的物品。如果該物品從冰箱盒上掉落，可能會導致人員受傷。
- 確保在安裝或拆除玻璃層架時要謹慎處理玻璃層架。如果您放下玻璃層架，它可能會破裂或造成傷害。

## 1 冰箱的周圍應確保足夠的通風空間。

- 此圖顯示了安裝冰箱所需的最小空間。在不同的空間尺寸下進行能源消耗測量條件。
- 冰箱周圍的空間越大，冰箱運行時的耗電量越小。
- 如果在小於下圖所列示的空間尺寸中使用冰箱，可能會導致裝置溫度升高、噪音大及故障。
- 冰箱後部與牆體之間的空間距離應為大於50 毫米且小於75 毫米。若此空間大於75 毫米，切勿觸摸在運行中過熱的壓縮機以及外圍部件，以免受傷。

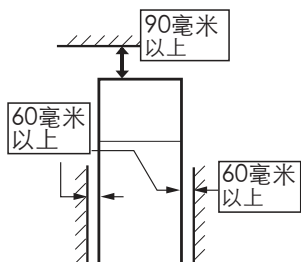

使用時所需總體空間

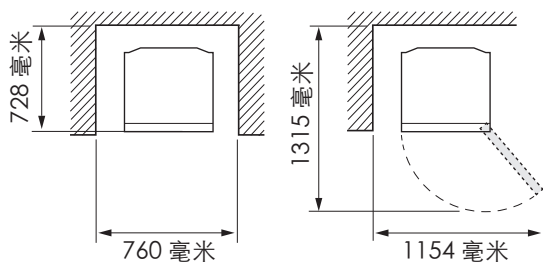

## 2 請利用前面的兩個調整腳，將冰箱穩妥地安裝在地板的水平位置上。

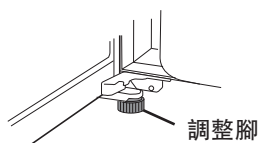

## 3 卸下冰箱櫃體下部的2 顆螺絲，然後用這些螺絲安裝設置腳蓋。（腳蓋附在冷藏室中。）

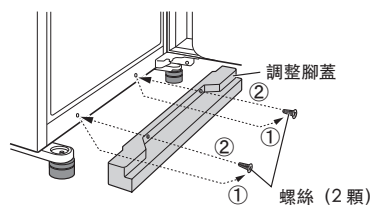

## 4 透過正確安裝的插座連接設備。

### 請注意

- 設置冰箱時要充分考慮便於插拔插銷。
- 請勿將冰箱放在陽光直射的地方或發熱機器的旁邊。
- 請勿將冰箱直接放在地面上。請在冰箱下面準備適當的台座，如木板。
- 在打開冰箱門的狀態下插入電源插銷時，會有冰箱門報警鳴響，但是這不屬於異常。關上冰箱門後報警就會停止。

### 腳輪位於冰箱底部

- 移動車輪使冰箱可以前後移動。



移動車輪

SJ-P498G, SJ-E438M, SJ-PG35P:2個  
SJ-P598G, SJ-E538M, SJ-PG39P, SJ-FTG15BVP:4個

### 在使用冰箱前

- 用溫水浸泡過的軟布清潔冰箱內部。
- 如果使用肥皂液，請用水徹底擦掉殘留肥皂液。



# 各部位名稱

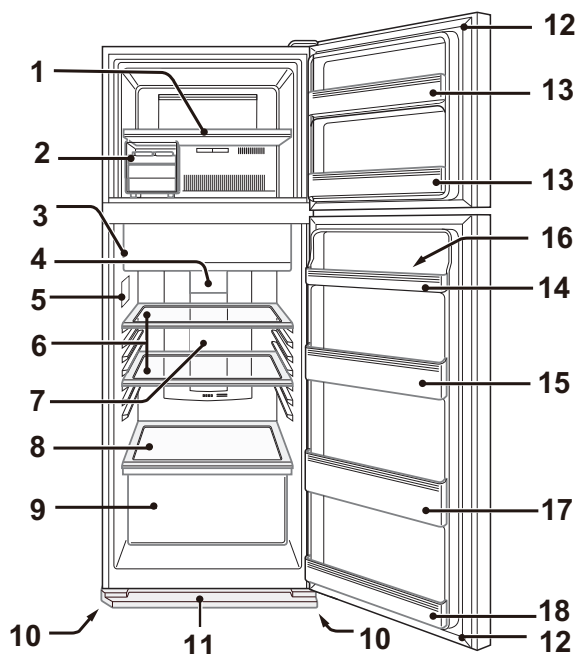

1. 冷凍室盤架

2. 可移動的製冰機

強烈建議使用這個製冰機，如上圖所示。

您可以將製冰機放在冷凍室的任何地方。

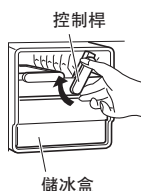

1) 請勿在冰格中裝滿水。

否則，製成的冰會連結在一起。

2) 冰製成以後，請按順時針方向轉動控制桿，將冰倒進儲冰盒內。

請注意

- 務必要將製冰機平放，使水不要從冰格中溢出。
- 為了防止冰塊盒受損，請勿在其中倒入油或加冰。

3. 保鮮盒·門

4. 冷藏室箱內燈

5. 控制面板

6. 冷藏室盤架 (2 個)

7. 混合冷卻面板

本面板從後部間接地使冰箱冷藏室變涼。這是一種冷藏食品的溫和的方法，不會使食品暴露在冷氣流之中。

8. 水果和蔬菜盤架

9. 水果和蔬菜保鮮室

10. 調整腳 (2 個)

11. 調整腳蓋

12. 門環 (2 個)

13. 冷凍室門盒 (2 個)

14. 蛋盒

SJ-P598G, SJ-E538M, SJ-PG39P, SJ-FTG15BVP : 1個  
SJ-P498G, SJ-E438M, SJ-PG35P: 2個

SJ-P498G, SJ-E438M, SJ-PG35P

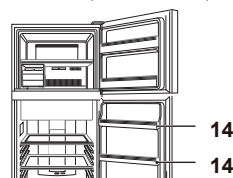

15. 冰箱盒 (上部)

(限於 SJ-P598G, SJ-E538M, SJ-PG39P, SJ-FTG15BVP)

16. 蛋架

17. 瓶盒

18. 冰箱盒 (底部)

**如果想要在冰箱內儲存大型物品**

- 您可能要卸下上圖中編號為 1、2、3、6、9 的任何層架或任何貯藏器。
- 即使您在以上情景中使用冰箱，其冷卻效能不受影響。

**脫臭裝置**

已經將脫臭觸媒設置在冷氣的通道上。不需要進行操作和清潔。



- ◻ 強力製冷
- ❄ 快速冷凍
- ❄ 快速製冷

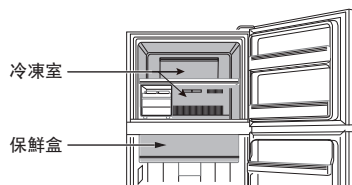

	強力製冷	快速冷凍	快速製冷
特點	可以用本功能將飲料或食品冷凍至冰冷狀態。 請注意:含水分高的食品可能會凍結。	可以用本功能加速冷凍食品。	本模式旨在快速冷卻飲料或食品。
應用位置	保鮮盒	冷凍室	冷凍室 安全注意事項:請勿放置玻璃瓶。玻璃瓶極可能會爆裂。
運行時間	6 小時 *1 • 本功能會自動結束。 • 警報器不會響起。	2 小時 *1	30 分鐘 • 本功能會自動結束。 • 警報器響起。 關閉警報器 *2 按下“快速冷凍”按鈕。
運行結束後	• 無需將飲料或食品取出。		• 報警器響起時，請務必取出飲料和食品。 • 如果將飲料或食品放置在冷凍室超過大概30 分鐘，飲料或食品可能會結冰。
若在操作期間發生斷電	• 本功能會自動取消		• 電源恢復後，本功能會自動重新啟動，恢復到之前的狀態。



\*1 當本功能與除霜功能重迭時，可能會更費時。因為本功能要在除霜之後啟動。

\*2 如果不關閉該警報器，警報器將持續響30 分鐘。

### 請注意

- 當強力製冷、快速冷凍和快速製冷其中一個功能正在運行時，另外的功能無法同時運行。
- 當這些功能運行之時，盡量避免開門。

## 淨離子群

(限於 SJ-P498G, SJ-P598G, SJ-PG35P, SJ-PG39P, SJ-FTG15BVP)

當冰箱通電時，淨離子群將自動進入工作狀態。

冰箱內的離子產生器將向冷藏室釋放出淨離子群。

淨離子群是正離子和負離子的集合體。

淨離子群能不活潑空氣中浮遊黴菌。

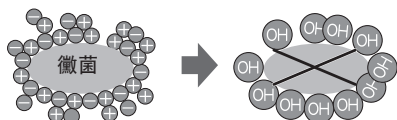

### 請注意

- 冰箱內可能有異味。這是離子發生器產生的臭氧的味道。臭氧密度非常小，釋放到冰箱內的臭氧會迅速分解。

# 控制面板

## 實用功能

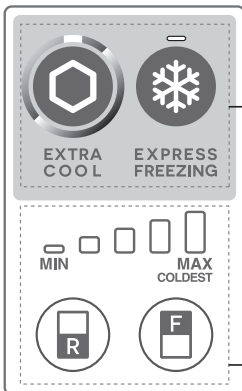

按鈕	含義	默認設置
	強力製冷	關閉
	快速冷凍	
	快速製冷	

## 溫度調節

按鈕	含義	默認設置
	冷藏室的溫度調節	
	冷凍室的溫度調節	

### 請注意

- 如需亮起指示器，請按下“F”或“R”按鈕。

## 實用功能的操作

	開始操作	取消運行
強力製冷	按下功能按鈕。 (嗶) 	按下功能按鈕。 (嗶) 
快速冷凍	按下功能按鈕。 (嗶) 	按下功能按鈕。 (嗶) 
快速製冷	按下功能按鈕3秒鐘或更多。 (嗶嗶嗶) 	按下功能按鈕。 (嗶) 

## 門報警器

- 當冰箱沒有關閉時，門報警器將會在開門1分鐘後響起，並過1分鐘後再次響起。
- 如果門保持開啟狀態約3分鐘，報警器將會連續響起。
- 門關閉後，警報將停止。

### 如果門報警器不停止發出警報

如果把所有的門關閉以後，門警鈴不停止發報警，就是有缺乏。  
請與夏普服務中心聯繫。

### 短暫停止門警鈴方法

- 同時按下“R”按鈕和“F”按鈕並持續3秒鐘或更多。
- 大約兩天以後，門警鈴在將向起來。



## 溫度調節

本冰箱會自動調節溫度。如有需要，亦可按如下方法調節溫度。

### 如何檢查當前溫度設置

按下“F”或“R”按鈕後，指示器亮起，顯示當前溫度等級。

冷凍室：按下“F”按鈕。

冷藏室：按下“R”按鈕。

### 冷凍室和冷藏室的設置

#### 冷凍室

1. 按下“F”按鈕。



2. 按下“F”按鈕，以改變溫度等級。

#### 冷藏室

1. 按下“R”按鈕。



2. 按下“R”按鈕，以改變溫度等級。

• 按下“F”或“R”按鈕後，溫度指示器將按照下圖（3→4→5→1→2→3）所示變化。

等級	指示器
1	
2	
3	
4	
5	

請注意

- 調整溫度等級後，指示器大約5秒鐘後關閉。
- 停電後溫度設置也會和停電前保持一致。

### 冷凍室和冷藏室的高級設置

根據以下步驟 **a** 到 **b**，冷藏室和冷凍室的溫度可按9個等級（1~9）來調節。

#### 冷凍室

**a.** 首先按下“F”按鈕。按住“F”按鈕的同時按下“快速冷凍”按鈕，並保持3秒鐘或更多。



指示器返回至“默認設置”。

**b.** 按下“F”按鈕，以改變溫度等級。

如果想以5個等級來調節溫度，則根據步驟**a**到**b**進行操作。

#### 冷藏室

**a.** 首先按下“R”按鈕。按住“R”按鈕的同時按下“快速冷凍”按鈕，並保持3秒鐘或更多。



指示器返回至“默認設置”。

**b.** 按下“R”按鈕，以改變溫度等級。

如果想以5個等級來調節溫度，則根據步驟**a**到**b**進行操作。

• 按下“F”或“R”按鈕後，溫度指示器將按照下圖（5→6→7→8→9→1→2→3→4→5）所示變化。

○ … 關閉    ◐ … 閃亮    }-{} … 閃爍

等級	指示器
1	
2	
3	
4	
5	
6	
7	
8	
9	

# 食品的儲存

- 確保食品品質最新鮮，以最大限度地延長易腐食物的儲存壽命。下面為延長食品保存期限的簡要介紹，可供您參考。
- 食物的儲存壽命有限。確保食品品質最新鮮，以最大限度地延長易腐食物的儲存壽命。

## 冷凍室

- 若要快速冷凍食品，每次都必須少量放入。
- 食品應進行恰當密封，要封緊或蓋緊。
- 將食品均勻地放入冷凍室。
- 袋子和容器上要標上標示，並寫清楚冷凍食品的內容。

## 冰箱

### 水果／蔬菜

- 為盡量減少水份的流失，水果和蔬菜要用保鮮紙及袋子（不封口）之類的塑膠袋輕輕包上，並將其放入蔬果保鮮室或水果盒內。
- 容易受低溫影響的水果和蔬菜應儲存在冰箱外的蔭涼處。

### 乳製品和雞蛋

- 幾乎所有乳製品的外包裝上都標有適當的保存溫度和保存期限。
- 請用箱內的蛋架保存雞蛋。

### 肉類／魚／禽肉

- 請將其放在容器上，並包上保鮮膜。
- 若是大塊的肉、魚和禽肉，請將其放在盤架的內側。
- 已經煮熟的食品務須用保鮮膜包好，或將其放在密封容器內。
- 新鮮食物（安全包裝）應在有限時間內儲存，以防止變質及嚴重影響其他儲存食物。

## 防止冰箱內部結水珠或結霜的建議

- 請妥善關好冰箱門。如果冰箱內的食品掉落，可能會導致冰箱櫃體和門之間形成縫隙。請將食品放回冰箱內的盤架或冰箱盒。
- 盡可能快速地開關冰箱門。如果冰箱門長時間開啟，或者頻繁地開關冰箱門，就可能會出現露水或結霜。
- 儲存的物品應使用食物罐或保鮮膜之類的東西包裝或密封好。（特別是高含水量的食物）

## 建議儲存食物

- 為使冷氣充分循環，請將食品均勻地放在盤架上。
- 請將較熱的食品涼下來以後，才保存起來。如果將較熱的食品放進冰箱，冰箱內的溫度會升高，這樣往往很容易導致食品腐爛變質。
- 請勿讓食品和容器擋住使冷氣循環的出風口和吸入口。否則，食品就不能均勻地冷卻。
- 請勿直接將食品放在冷氣出風口旁。這樣會引致食品凍結。

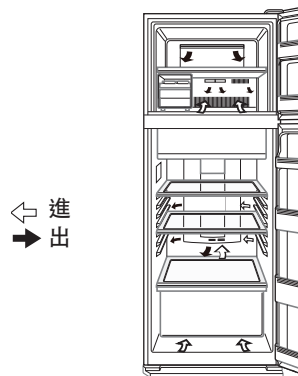

## 節約能量的竅門

- 把冰箱安裝在通風良好的地方，並保持通風。
- 請勿將冰箱放在陽光直射的地方或發熱機器的旁邊。
- 盡量避免開門。
- 請將較熱的食品涼下來以後，才保存起來。
- 為使冷氣充分循環，請將食品均勻地放在盤架上。

- 這個型號的能源消耗量如下圖所示。

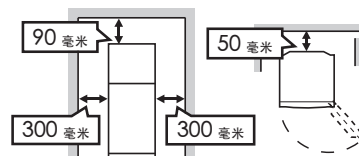

## 重要提示

遵循下面貼士，防止內部表面與塑膠元件出現裂痕

- 食用油沾上塑料部件時，請將之擦掉。
- 某些家用化學洗滌劑可能會導致冰箱損傷，因而只能使用稀釋過的廚房用洗滌劑（肥皂水）。
- 如果使用未稀釋的洗劑或者未徹底擦淨肥皂水，則有可能損壞冰箱的塑料部件。

## 清潔

- 拆下冰箱櫃體或門上的附件，如盤架。用溫水和廚房用洗滌劑清洗，然後，用水洗清並使之乾透。（只有水果和蔬菜盤架不是可動式的）
- 冰箱內部要用浸泡在廚房用洗滌劑的溫水裡的布塊擦洗。然後，用冷水將肥皂水徹底擦乾淨。
- 冰箱的外殼沾上污漬時，請用柔軟的布塊擦洗。
- 冰箱門環要用廚房用洗滌劑的溫水和牙刷洗淨。
- 請用乾布擦拭控制面板。

### 請注意

- 請勿使用強力清潔劑或溶劑（油漆、塗料、拋光粉、汽油、沸水等），否則可能導致冰箱損傷。
- 一旦拔出電源插頭，請等待至少5分鐘之後再重新接通電源。
- 一塊玻璃盤架約重2kg。從箱內抽出或搬運時請小心托牢。
- 在冰箱內請勿使物體掉落，或用物體強烈碰撞內壁。否則可能導致內壁破裂。

## 搬運之前

- 擦拭乾淨蒸發盤裡的水。擦乾之前，請務必等待1小時以上，然後拔出插頭，因為製冷循環設備是非常熱。（蒸發盤位於產品的背面。）

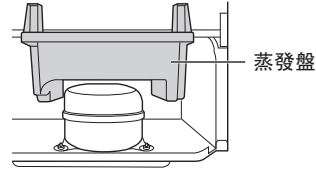

## 對冷卻裝置進行除霜作業

- 本冰箱透過獨特的節約能源系統，完全實現自動除霜。（大約一天一次。）製冰需要時間，因為在除霜過程中，內部的溫度會比平常稍高。

## 當冷藏室內燈損壞時

- 請聯繫SHARP 認可的售後服務中心更換內燈。非專業服務人員不得更換內燈。

## 切斷冰箱的電源時

如果冰箱需要長時間關閉，則應採取以下步驟以減少黴菌生長

1. 拿出所有食物。
2. 從插座處拔除電源插頭。
3. 徹底清潔並乾燥內部區域。
4. 保持所有冰箱門稍微開放幾天進行乾燥。

# 送修之前的初步檢查

送修之前，請對下列地方進行檢查。

問題	對策
冰箱外箱有時會變熱。	這並非異常。這是由於櫃內的熱管以防產生露水。
冰箱會發出很大的噪音。	之後的聲音正常。 <ul style="list-style-type: none"><li>• 壓縮機開始運作時會發出很大的噪音 --- 不久聲音會變小。</li><li>• 壓縮機每日一次發出較大噪音 --- 在冷卻裝置的自動除霜作業之後，立即會發出運作聲音。</li><li>• 液體流動的聲音（咕嚕聲、嘶嘶聲） --- 這是由於冷卻劑在管道中流動造成的（聲音可能會偶爾變得更響亮）。</li><li>• 劈啪聲或吱嘎聲，吱吱聲 --- 這是由於在冷卻過程中內壁和內部零件的膨脹與構造造成的。</li></ul>
冰箱內部和冰箱外側結霜或結露。	在下列情形下有可能發生這種現象。請用濕布擦掉霜，用乾布擦掉露珠。 <ul style="list-style-type: none"><li>• 周圍溫度較高時。</li><li>• 頻繁開啟冰箱門時。</li><li>• 冰箱內存放水分較多的食品時。（請用保鮮膜包上）</li><li>• 這一現象或多或少取決於季節（雨季，季節）、使用習慣和每個房屋的環境條件。</li></ul>
冷凍室內的食物被冰凍。	<ul style="list-style-type: none"><li>• 是否長期冷藏室溫度調節為MAX COLDEST的狀態下使用冰箱？ --- 將溫度調節設定改為其他設定。</li><li>• 是否長期冷凍室溫度調節設定MAX COLDEST的狀態下使用冰箱？ --- 將溫度調節設定改為其他設定。</li><li>• 在環境溫度較低時，即使將冷藏室溫度調節控制到MIN，食品有時也會被凍結。</li></ul>
冰箱內部有異味。	<ul style="list-style-type: none"><li>• 請將氣味較強的食品用保鮮紙包起來。</li><li>• 脫臭裝置不能去掉所有異味。</li><li>• 定期清潔內部。</li></ul>

## 經檢查後仍需要送修時

請與就近的SHARP認可的售後服務中心洽詢。



# **SHARP**

SHARP CORPORATION

Printed in Thailand

TINS-B886CBZ 18BF (TH) ①