

SHARP

Refrigerator - Freezer Operation manual

SJ-SS52ES2-SL SJ-SS52EG2-BK

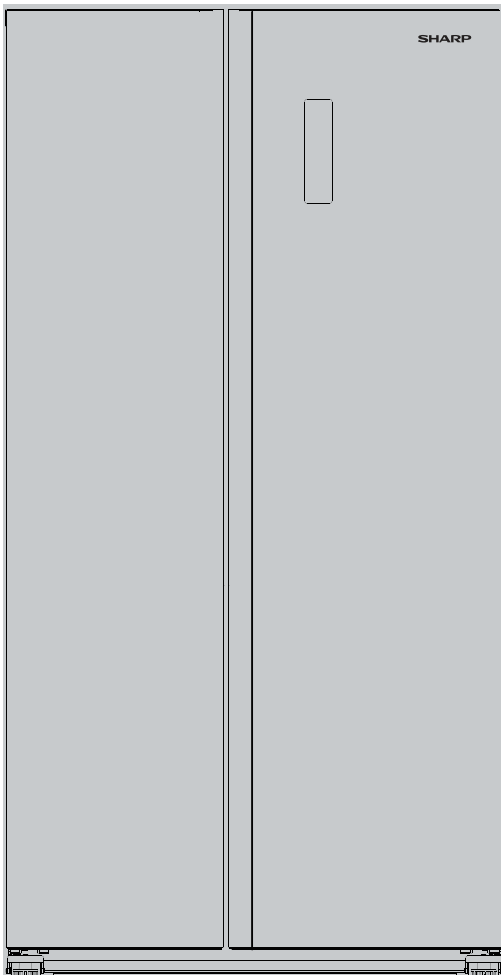



Contents

• Safety information	2
• Installation	4
• Description	5
• Operation	6
• Care and cleaning	9
• Storing food	10
• Before you call for service	11

Thank you very much for buying this SHARP product. Before using your SHARP refrigerator, please read this operation manual to ensure that you gain the maximum benefit from it.
 This refrigerator is for household only, with ambient temperature between +10°C and +43°C. The refrigerator should not be subjected to temperatures of -10°C or below for a long period of time.

Household use only

Safety information

	Warning	This means that there are high risks of death or serious injury.
	Caution	This means that there are high risks of material damage or personal injury.
	Caution	Fire marks means this refrigerator has risk of fire accident.



Warning

Refrigerant

This refrigerator contains flammable refrigerant (R600a: isobutane) and insulation blowing gas (cyclopentane). Observe the following rules to prevent ignition and explosion.

- Do not damage the refrigerant circuit.
- Do not allow any sharp objects to have contact with the refrigeration system. The refrigeration system behind and inside the refrigerator contains refrigerant. Leaking refrigerant can ignite and may damage the eyes.
- Do not use mechanical devices or other means to accelerate the defrosting process. (This refrigerator has an automatic defrosting system.)
- Do not use electrical appliances inside the refrigerator.
- Do not block the space around the refrigerator.
Do not use flammable sprays, such as spray paint near the refrigerator.
- Do not store flammable sprays, such as spray paint in the refrigerator.
- In the case of failure of the refrigeration system, do not touch the wall socket and use open flames. Open the window and air out the room. Then ask a service agent approved by SHARP for service.

Power cord, Plug, Socket

Read carefully the following rules to prevent electric shock or fire.

- Make sure to protect the power cord from being damaged during installation or moving. If the power plug or cord is loose, do not insert the power plug.
- Do not place multiple portable socket-outlets or portable power supplies at the rear of the refrigerator.
- Connect the power plug into the wall socket firmly and directly. Do not use an extension cord or adapter plug.
- Connect the power plug to the socket with the required rated voltage.
- Connect the earth pin to the earth terminal properly.
- Do not touch the power plug with wet hands.

- Disconnect from the main electricity supply by removing the main plug from the socket. Do not remove by pulling the power cord.
- Dust deposited on the power plug may cause fire. Wipe it off carefully.
- Pull out the plug if the refrigerator is not used for a long time.
- If the flexible supply cord is damaged, it must be replaced by service agent approved by SHARP in order to avoid a hazard.

Installation

- Do not install the refrigerator in a damp or wet location. It may cause the damage to the insulation or electrical leak. Dew may also appear on the outer cabinet and it causes rust.
- The refrigerator should be installed flatly and firmly on the floor.

In use

- Do not store volatile and flammable materials such as ether, petrol, propane gas, aerosol cans, adhesive agents and pure alcohol etc. These materials are easy to explode.
- Do not store temperature-sensitive products such as pharmaceutical products in the refrigerator. There are high risks of changes in product quality.
- Do not attempt to change or modify this refrigerator. This may result in fire, electric shock or injury.
- Do not place any object on the top of refrigerator. If the object falls down from the top, it may cause injury.
- Do not hit the glass doors hard. Otherwise, they may break and cause physical injury.
- This appliance can be used by children aged from 8 years or above and persons with reduced physical, sensory or mental capabilities or lack of experience and knowledge if they have been given supervision or instruction concerning use of the appliance in a safe way or understanding the hazards involved. Children shall not play with the appliance. Cleaning and user maintenance shall not be done by children without supervision.

Care and Cleaning

- Unplug the refrigerator first to prevent electric shock.
- Do not splash water directly on the outer cabinet or the interior. This may lead to rusting and deterioration of the electrical insulation.

Trouble

- If you smell something burnt, pull out the power plug immediately. Then ask a service agent approved by SHARP for service.
- In case of gas leak, ventilate the area by opening window. Do not touch the refrigerator or the power socket.



Caution

Transportation

- When you install or move your refrigerator, use curing mat to protect the floor from being damaged.
- Carry the refrigerator securely. If you lift up the refrigerator improperly, it may cause injury.

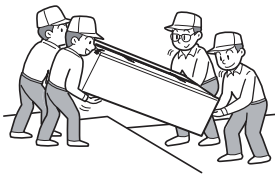

Disposal

- Ensure that the refrigerator presents no danger to children while being stored for disposal. (e.g. remove the magnetic door seals to prevent child entrapment.)
- This refrigerator should be disposed appropriately. Take the refrigerator to a professional recycling plant for flammable refrigerant and insulation blowing gases.

In use

- Do not touch foods or metal containers in the freezer compartment with wet hands. This may cause frostbite.
- Do not place bottled drinks and cans in the freezer compartment.
- Do not use other than potable water to make ice cubes.
- Do not open or close the door when other people put a hand near the door. There is a risk that the other people may get their fingers caught in the door.
- Do not put oversized object in the pockets of the door. If the object falls down from the pockets, it may cause injury.
- Make sure to handle the glass shelves with care to install or uninstall. If you drop the glass shelves, it may break or cause injury.

1 Keep adequate ventilation space around the refrigerator.

- The figure shows the minimum required space for installing the refrigerator. The amount of space around the refrigerator affects the amount of power consumption.
- Insufficient spacing will decrease cooling efficiency and increase energy consumption. This may reduce the life of the unit and void warranty.
- If using the refrigerator in the smaller space dimension than figured, it may cause temperature rise in the unit, loud noise and failure.
- The space between the rear of the refrigerator and the wall should be 50 mm or more.

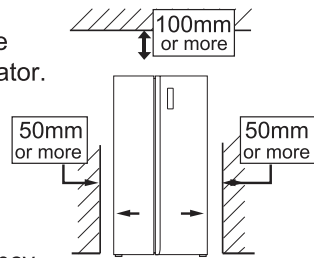

Overall space required in use

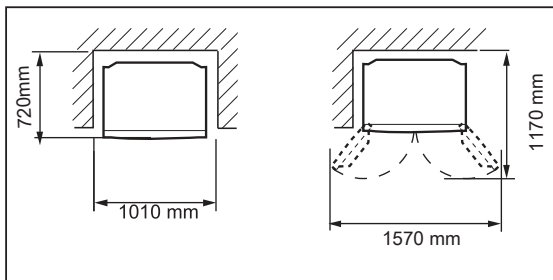

2 Use the two front adjustable feet to place the refrigerator flatly and firmly on the floor.

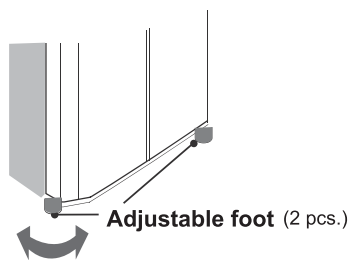

3 Connect the appliance via a correctly installed socket.

Note

- Position your refrigerator so that the plug is accessible.
- Keep your refrigerator out of direct sunlight and do not place next to heat generating appliance.
- Do not place your refrigerator directly on the ground. Insert suitable stand such as wooden board under the refrigerator.

Before using your refrigerator

Clean the inside parts with a cloth soaked in warm water. If soapy water is used, wipe it off thoroughly with water.

Description

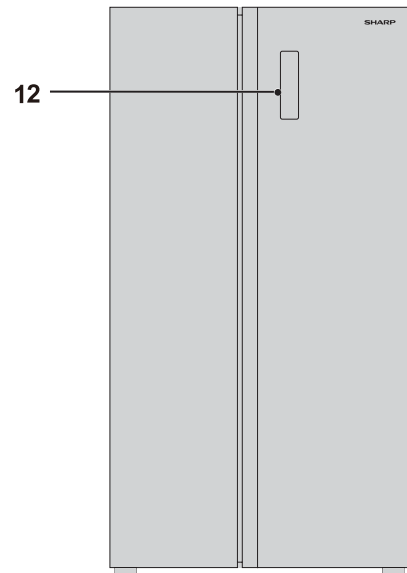
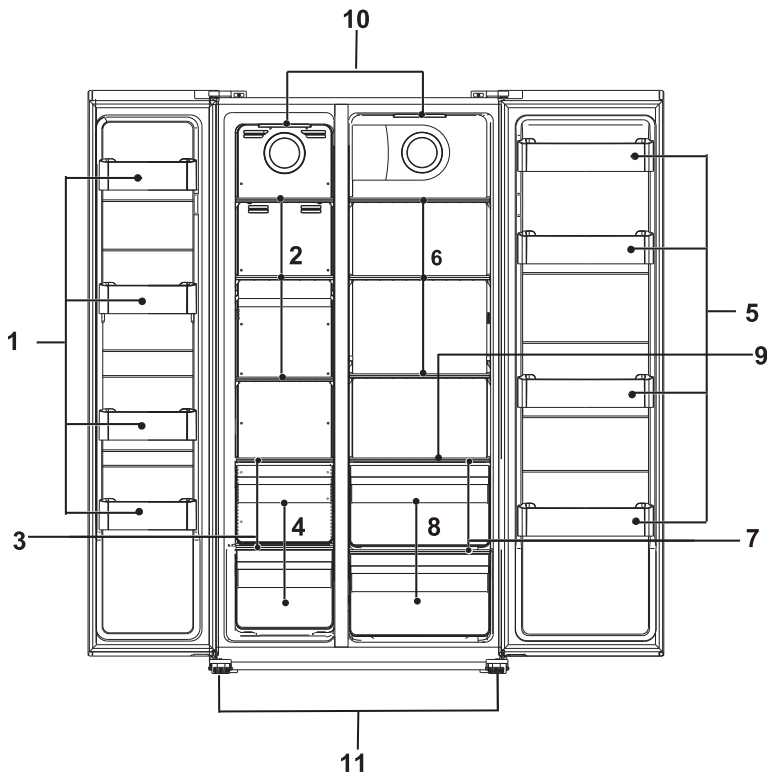

- 1. Freezer door pocket (4 pcs)
- 2. Freezer shelf (3 pcs)
- 3. Freezer drawer cover (2 pcs)
- 4. Freezer drawer (2 pcs)
- 5. Refrigerator door pocket (4 pcs)
- 6. Refrigerator shelf (3 pcs)
- 7. Crisper drawer cover (2 pcs)
- 8. Crisper drawer (2 pcs)
- 9. Deodorizer
- 10. LED light (2 pcs)
- 11. Adjustable foot (2 pcs)
- 12. Control panel

How to make ice cubes

- Pour the water into the twist ice maker.

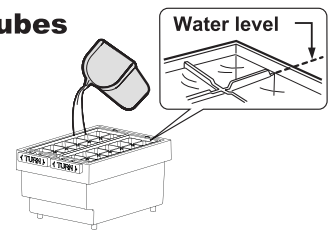

- When ice cube are made, turn the lever of twist ice maker to take out the ice cubes.

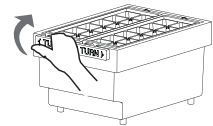

Following parts are included with shipment.

Egg holder

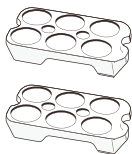

Twist ice maker

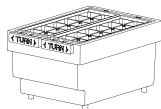

Deodorizing unit

There is no need to operate and clean.
Don't remove Deodorizing unit by yourself.
Don't touch with Deodorizer (black part).

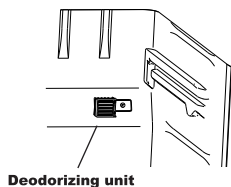

Deodorizing unit

Door alarm

- When the refrigerator or freezer door is left open for over 1 minute, the alarm sounds 5 times (Beep beep beep beep beep).
If you do not close the door, the alarm sounds every 25 seconds.
- The alarm stops after close all doors.

Operation

Setting temperature indication

The temperature that indicated on the control panel is not the exact temperature inside.

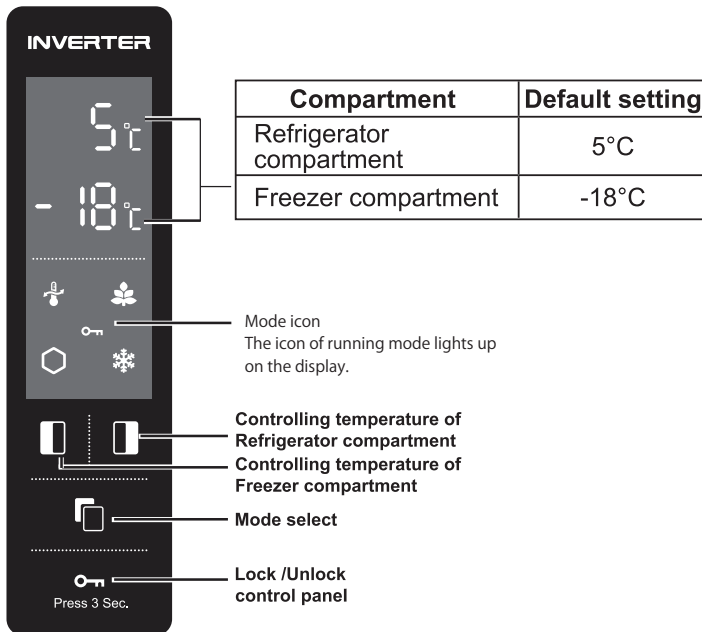

	Function	Default setting
	Smart mode	OFF
	Energy saving	
	Extra cool	
	Express freezing	
	Control panel lock	-

Note

- When you press one of the keys, the display lights up.
- All modes are off initially.
- When there is no key operation for approximately 2 minutes, the display turns off.

Control panel lock

- Control panel is locked automatically 25 seconds after the last key operation (Mode icon lights up on the display after the beep).
- Touch key for 3 seconds or more to unlock.
- If you want to lock the control panel, touch key for 3 seconds or more right after the mode icons (selected temperatures) light up.

Controlling temperature

The refrigerator controls its temperature automatically. You can adjust the temperature as below if you need.

Refrigerator compartment

The temperature is adjustable between 2°C and 8°C in step of 1°C and "OFF" (-).

(This setting is valid except for Smart mode, Energy saving and Extra cool.)

How to operate

- 1 Touch key and select temperature.

(Temperature changes each time you touch the key.)



- 2 (Flashing (5times)) → (Selected temperature lights up.)

Note

- For hygienic reasons, do not put foods in the refrigerator compartment while the setting is "OFF" (-).

Freezer compartment

The temperature is adjustable between -14°C and -22°C in step of 1°C.

(This setting is valid except for Smart mode, Energy saving and Express freezing.)

How to operate

- 1 Touch key and select temperature.

(Temperature changes each time you touch the key.)



- 2 (Flashing (5times)) → (Selected temperature lights up.)



Smart mode

Use this mode to set the suitable temperature according to the ambient temperature.



How to operate

- 1 Select the mode icon.



- 2  (The icon lights up.)

Follow steps 1 to 2 again to turn off this mode (the mode icon turns off) .

- Temperature setting of this refrigerator is adjusted automatically according to the internal and ambient temperature. Suitable temperature settings show up on the display.
- Temperature setting is not accepted during this mode. If you touch  or  key, mode icon () flashes 3 times. (Indicated temperature cannot be changed.)



Energy saving

Use this mode to switch the appliance to energy-saving operation.

How to operate



- 1 Select the mode icon.

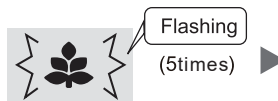

- 2  (The icon lights up.)

Follow steps 1 to 2 again to turn off this mode (the mode icon turns off) .

- Temperature setting during this mode is as follows.

Refrigerator compartment : 8°C	(Unadjustable)
Freezer compartment : -15°C	(Unadjustable)
- Temperature setting is not accepted during this mode. If you touch  or  key, mode icon () flashes 3 times. (Indicated temperature cannot be changed.)
- Cancel this mode if you feel the beverages are not cooled enough or ice making takes longer time.

Tips for saving energy

- Install the refrigerator in a well-ventilated area and keep the space to ventilate.
- Keep your refrigerator out of direct sunlight and do not place it next to heat generating appliance.
- Avoid opening the door as much as possible.
- Hot food should be cooled before storing.
- Place the food evenly on the shelves to allow the cool air to circulate efficiently.

Extra cool

Use this mode to cool beverage or food quickly.

How to operate

- 1 Select the mode icon.



- 2  Flashing
(5times) 
(The icon lights up.)



Follow steps 1 to 2 again to turn off this mode (the mode icon turns off).

- Temperature setting during this mode is as follows.

Refrigerator compartment: 2°C (Unadjustable)

Freezer compartment : -14°C ~ -22°C (Adjustable)

- Temperature setting for refrigerator compartment is not accepted during this mode. (Temperature is changed to 2°C automatically.)

If you touch  key, mode icon () flashes 3 times. (Indicated temperature cannot be changed.)

- This mode ends automatically 2.5 hours later after setting.



Express freezing

Use this mode to freeze food quickly not to lose its flavor.

How to operate

- 1 Select the mode icon.



- 2  Flashing
(5times) 
(The icon lights up.)



Follow steps 1 to 2 again to turn off this mode (the mode icon turns off).

- Temperature setting during this mode is as follows.

Refrigerator compartment: 2°C ~ 8°C/"OFF" (-) (Adjustable)

Freezer compartment : -25°C (Unadjustable)

- Temperature setting for freezer compartment is not accepted during this mode. (Temperature is changed to -25°C automatically.)

If you touch  key, mode icon () flashes 3 times. (Indicated temperature cannot be changed.)

- This mode ends automatically 50 hours later after setting.

Note

- Large food cannot be frozen in a single operation.
- Avoid opening the door as much as possible during operation of this mode.
- The operating sound may become louder than usual while this mode is ON but it is normal.

Care and cleaning

Important

To prevent cracks on inside surfaces and plastic components, follow these tips .

- Wipe out food oil adhered to plastic parts.
- Some household chemicals may cause damage, so use only diluted washing-up liquid (soapy water).
- If undiluted detergent is used or soapy water is not wiped off thoroughly, it may result in cracks of plastic parts.

Cleaning

For hygienic reasons, make sure to do following things regularly.

- Remove the accessories (e.g. shelves) from the cabinet and the door. Wash them by warm soapy dishwashing water. After that, rinse them in clean water and dry.
- Clean the inside with a cloth soaked in warm soapy dishwashing water. Then, use cold water to wipe off soapy water thoroughly.
- Wipe the exterior with a soft cloth each time it gets dirty.
- Clean the magnetic door seal with a toothbrush and warm soapy dishwashing water.
- Wipe the control panel with a dry cloth.

Note

- Do not use hot water, household cleaning powders, creams or spray-on cleaning products, or any other cleaning products such as mineral turpentine, methylated spirits, thinners, petrol etc. These may damage your refrigerator and may void any warranty.
- If the power supply is disconnected, please wait at least 5 minutes before re-connecting power.
- The glass shelves are heavy to carry. Hold them firmly when you remove the shelves from the cabinet .
- Do not drop objects inside the refrigerator or strike the inner wall. This may cause cracks to inner surface.

Switching off your refrigerator

If the refrigerator needs to be switched off for an extended period, the following steps should be taken to reduce the growth of mold:

1. Remove all food.
2. Remove the power plug from the socket.
3. Clean and dry the interior thoroughly.
4. Keep all the doors open slightly for a few days to dry.

Defrosting

Defrosting is automatically operated by a unique energy saving system.

When the compartment light is blown

Contact the service agent approved by SHARP to replace the light. The light is not to be replaced other than by qualified service personnel.

Storing food

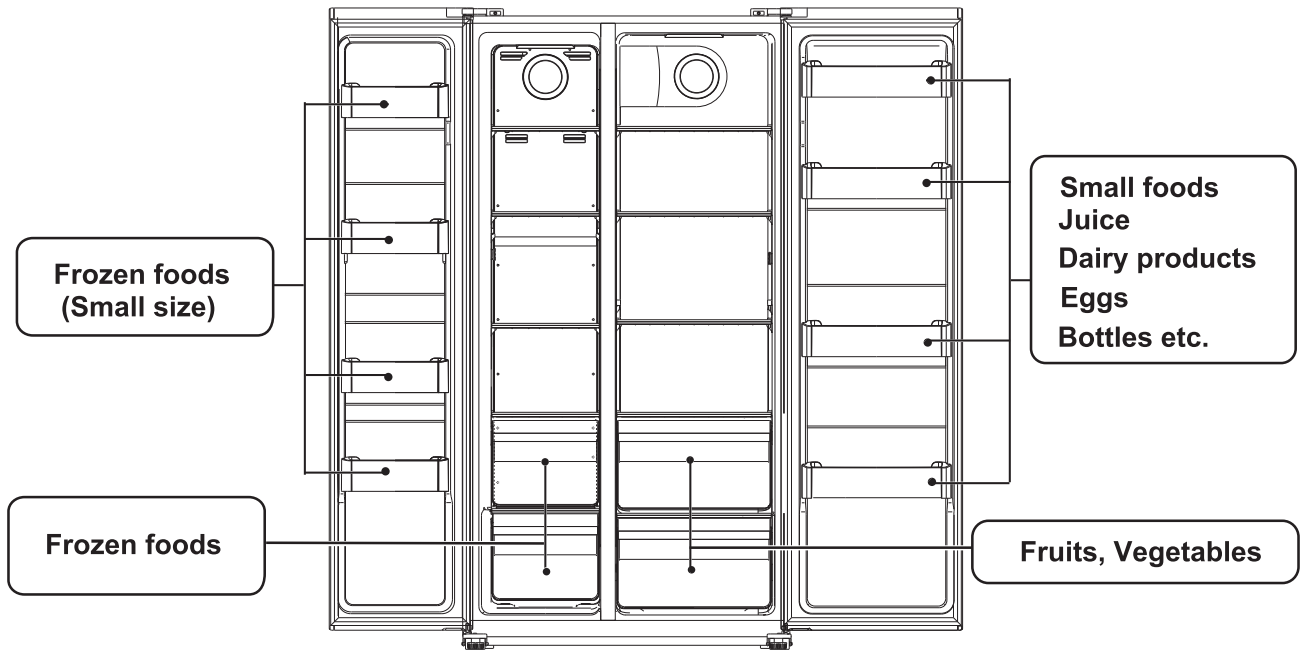

Refrigeration reduces the rate of food spoilage.

Ensure that the food is of the freshest possible quality to maximize the shelf life of perishable foods.

The following is a general guide to help promote longer food storage.

Fruit / Vegetables

Fruit and vegetables should be loosely enclosed in a plastic material e.g. wrap, bags (do not seal) and placed in the Fruit and vegetable crisper to minimize moisture loss.

Dairy Products & Eggs

- Most dairy products have their best-before date on the outer packaging which informs the recommended temperature and shelf life of the foods.
- Eggs should be stored in the Egg tray.

Meats / Fish / Poultry

- Place on a plate or a dish and cover with paper or plastic wrap.
- For larger cuts or meat, fish, or poultry, place to the rear of the shelves.
- Ensure all cooked food is wrapped securely or placed in an airtight container

* Notes for fresh food:

- Fresh food (securely wrapped) should be stored in limited time to prevent spoilage and badly affecting other stored foods.

For best freezing

- Quality of foods should be fresh.
- Freeze small quantities of food at a time in order to freeze them quickly.
- Food should be properly sealed or covered tightly.
- Place foods in the freezer evenly.
- Label bags or containers to keep an inventory of freezing food.

Advice for preventing dew or frost inside the refrigerator

- Keep the door securely closed. If the food falls down, it may cause a gap between the cabinet and the door. Move it back to the shelf or the pocket.
- Food with high-moisture should be stored in airtight container or sealed tightly.

Note

- Evenly place the food on the shelves to allow the cooling air to circulate efficiently.
- Hot foods should be cooled before storing. Storing hot foods increases the temperature in the unit and risk of food spoilage.
- Opening the door for long periods can cause a significant increase of the temperature in the compartments of the appliance.
- Do not block the outlet and inlet of the cool air circulating circuit with foods or containers; otherwise the food is not be evenly cooled throughout the refrigerator.

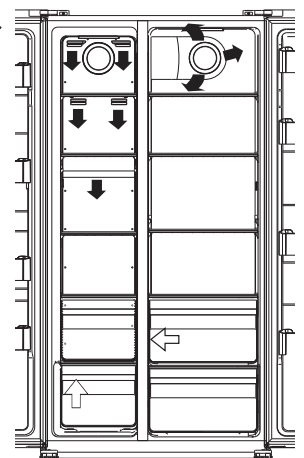





← IN
→ OUT

Do not place food directly in front of cold air outlet. This may lead to the food freezing.

Before you call for service

Before calling for service, check the following points.

Problem	Solution / Situation
The outside of the cabinet is hot when touched.	It is normal. This is because of the hot pipe is in the cabinet in order to prevent dew generation
Refrigerator makes loud noise.	<p>Following sounds are normal.</p> <ul style="list-style-type: none"> • The compressor makes loud noise when its operation starts. <ul style="list-style-type: none"> -- Sound becomes quieter after a while. • The compressor makes loud noise once a day. <ul style="list-style-type: none"> -- Operating sound is made immediately after automatic defrost operation of the cooling unit. • Sound of flowing fluid (gurgling sound, fizzing sound). <ul style="list-style-type: none"> -- It is caused by refrigerant flowing in pipes (sound may become louder from time to time). • Cracking or crunching sound, squeaking sound <ul style="list-style-type: none"> -- It is caused by expansion and contraction of inner walls and internal parts during cooling.
Frost or dew appears inside or outside the refrigerator.	<p>This may occur in one of the following cases. Use a wet cloth for wiping frost and a dry cloth for wiping dew.</p> <ul style="list-style-type: none"> • When the ambient humidity is high. • When the door is frequently opened and closed. • When food containing plenty of moisture are stored. (Wrapping is required.)
The food in the refrigerator compartment are frozen.	<ul style="list-style-type: none"> • Is the refrigerator temperature control set at 2°C for a long time? <ul style="list-style-type: none"> -- Change the temperature control to 5°C or warmer. • Is the freezer temperature control set at -22°C for a long time? <ul style="list-style-type: none"> -- Change the temperature control to -18°C or warmer. • If ambient temperature is low, food may freeze even if the refrigerator compartment is set at 8°C.
Odors in the compartment.	<ul style="list-style-type: none"> • Wrapping is required for the food with strong odors.
Door alarm does not stop.	<ul style="list-style-type: none"> • The alarm stops after close the door.
The control panel does not work.	<p>This may occur in one of the following cases.</p> <ul style="list-style-type: none"> • Control panel is locked automatically 25 seconds after the last key operation. <ul style="list-style-type: none"> Press On key for 3 seconds or more to unlock. • The panel or your finger is soiled with dripping, oil and etc. • When you touch the panel with gloved hand, adhesive bandage on your finger, nail or objects. • Sticker or tape is affixed on the keys. • Touch position is slightly off from the keys. • Operate time is not enough for the keys to work.
Error indicator (    ) appears on the display.	Make sure to contact service agent approved by SHARP.

If you still require service

Refer to your nearest service agent approved by SHARP.

SHARP
SHARP CORPORATION