

SHARP®

AQUOS

LC-40SA5200X LC-50SA5200X

LED BACKLIGHT TV

OPERATION MANUAL

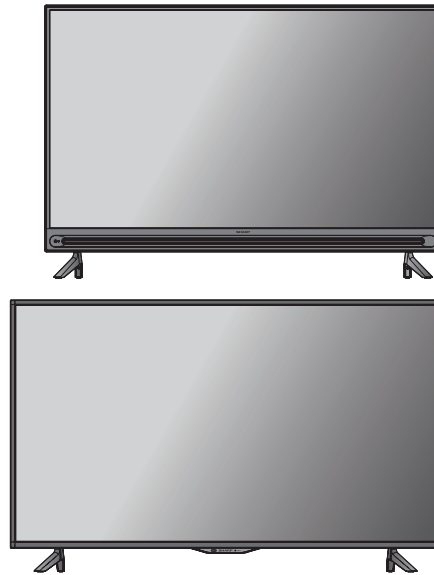

HDMI™
HIGH-DEFINITION MULTIMEDIA INTERFACE

LED

DVB-T2

DOLBY AUDIO™

Supplied accessories

Remote control unit

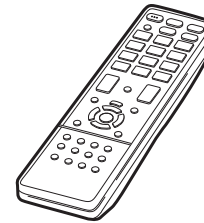

"AAA" size battery (×2)

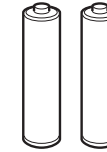

Operation manual

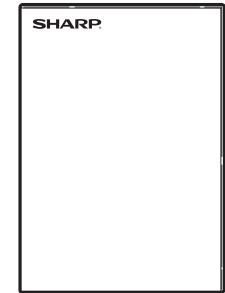

Stand unit

LC-40SA5200X

Stand base with letter "L"

Stand base with letter "R"

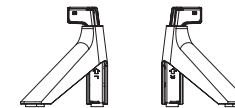

Stand assembly



Screws (× 4)

LC-50SA5200X

Stand base with letter "L"

Stand base with letter "R"

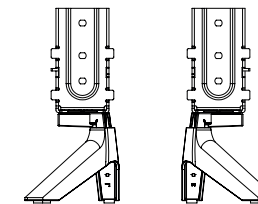

Stand assembly



Screws (× 4)

Dear SHARP customer

Thank you for your purchase of the SHARP LCD colour TV product. To ensure safety and many years of trouble-free operation of your product, please read the Important Safety Precautions carefully before using this product.

Contents

	Page		Page
Dear SHARP customer.....	1	Picture settings.....	17
Supplied accessories.....	2	Audio settings.....	18
Important Safety Precautions	3	System options.....	19
Trademarks.....	4	Programme Guide	21
Attaching the stand.....	5	Info.....	21
Antenna connection.....	6	ATV/DTV/RADIO buttons	21
Connecting external devices.....	7	Switching the analogue audio	
Remote control unit	9	format	22
Part names.....	10	EPG.....	23
Turning the TV on/off	12	SUPER ECO mode.....	23
Easy setup.....	12	Colour adjustment and still image.....	24
Digital setting.....	12	Teletext function.....	24
Analogue setting.....	13	PC compatibility chart	25
Menu operation.....	13	USB Media Player.....	26
Initial setup.....	14	Appendix	29
Information.....	17	Specifications	30

Printed in Malaysia
TINS-G870WJZZ △
17P10-MA-NF

EN - 1

EN - 2

Important Safety Precautions

- Stand base must be attached to prevent the TV set from falling down and cause injuries.
- Cleaning — Unplug the AC cord from the AC outlet before cleaning the product. Use a soft damp cloth to clean the product. Do not use liquid cleaners, aerosol cleaners or chemical cloth to clean it, as such materials may damage the product.
- Water and moisture — Do not use the product near water, such as bathtub, washbasin, kitchen sink, laundry tub, swimming pool and in a wet basement.
- Do not place vases or any other water-filled containers on this product.
The water may spill onto the product causing fire or electric shock.
- Stand — Do not place the product on an unstable cart, stand, tripod or table. Doing so can cause the product to fall, resulting in serious personal injuries as well as damage to the product. Use only a cart, stand, tripod, bracket or table recommended by the manufacturer or sold with the product. When mounting the product on a wall, be sure to follow the manufacturer's instructions. Use only the mounting hardware recommended by the manufacturer.
- When relocating the product placed on a cart, it must be moved with utmost care. Sudden stops, excessive force and uneven floor surface can cause the product to fall from the cart.
- Ventilation — The vents and other openings in the cabinet are designed for ventilation. Do not cover or block these vents and openings since insufficient ventilation can cause overheating and/or shorten the life of the product. Do not place the product on a bed, sofa, rug or other similar surface, since they can block ventilation openings. This product is not designed for built-in installation; do not place the product in an enclosed place such as a bookcase or rack, unless proper ventilation is provided or the manufacturer's instructions are followed.
- The LCD panel used in this product is made of glass. Therefore, it can break when the product is struck forcefully or with a sharp object. If the LCD panel is broken, be careful not to be injured by broken glass.
- Heat sources — Keep the product away from heat sources such as radiators, heaters, stoves and other heat-generating products (including amplifiers).
- To prevent fire, never place any type of candle or naked flames on the top or near the TV set.
- To prevent fire or shock hazard, do not place the AC power cord under the TV set or other heavy items.
- Do not place heavy objects on this product or stand on it. Doing so could cause injury if the product overturns. Take special care near children and pets.
- The LCD panel is a very high technology product with 2,073,600 pixels, giving you fine picture details.
Due to the very large number of pixels, occasionally a few non-active pixels may appear on the screen as a fixed point of blue, green or red.
This is within product specifications and does not constitute a fault.
- **Precautions when transporting the TV**
When transporting the TV, never carry it by holding or otherwise putting pressure onto the display. Be sure to always carry the TV by two people holding it with two hands — one hand on each side of the TV.
- Do not display a still picture for a long time, as this could cause an afterimage to remain.
- Install the product on the place where the AC cord can be unplugged easily from the AC outlet or from the AC INPUT terminal on the rear of the product.
- If a television is not positioned in a sufficiently stable location, it can be potentially hazardous due to falling. Many injuries, particularly to children, can be avoided by taking simple precautions such as:
 - Using cabinets or stands recommended by the manufacturer of the television.
 - Only using furniture that can safely support the television.
 - Ensuring the television is not overhanging the edge of the supporting furniture.
 - Not placing the television on tall furniture (for example, cupboards or bookcases) without anchoring both the furniture and the television to a suitable support.
 - Not standing the televisions on cloth or other materials placed between the television and supporting furniture.
 - Educating children about the dangers of climbing on furniture to reach the television or its controls.
- Do not install the TV in a location in which it will be subject to water drops such as underneath an air conditioning unit or in the vicinity of a humidifier.
 - Water drops falling onto the TV and water entering inside it may result in fire, electric shock, or malfunctions.
 - We recommend that you install the TV at least 1 m away from the outlet of an air conditioner.

Trademarks

- The terms HDMI and HDMI High-Definition Multimedia Interface, and the HDMI Logo are trademarks or registered trademarks of HDMI Licensing Administrator, Inc. in the United States and other countries.
- Manufactured under license from Dolby Laboratories. Dolby, Dolby Audio, and the double-D symbol are trademarks of Dolby Laboratories.
- LC フォント、LCFONT、エルシーフォント and LC logo mark are registered trademarks of SHARP Corporation. This product is embedded with LC Font technology, which was developed by SHARP Corporation for clearly displaying easy-to-read characters on an LCD screen. However, other non-LCD fonts are used for displaying some screen pages.
- ANY USE OF THIS PRODUCT IN ANY MANNER OTHER THAN PERSONAL USE THAT COMPLIES WITH THE MPEG-2 STANDARD FOR ENCODING VIDEO INFORMATION FOR PACKAGED MEDIA IS EXPRESSLY PROHIBITED WITHOUT A LICENSE UNDER APPLICABLE PATENTS IN THE MPEG-2 PATENT PORTFOLIO, WHICH LICENSE IS AVAILABLE FROM MPEG LA, LLC, 6312 S. Fiddlers Green Circle, Suite 400 E, Greenwood Village, Colorado 80111 U.S.A.
- THIS PRODUCT IS LICENSED UNDER THE VC-1 PATENT PORTFOLIO LICENSE FOR THE PERSONAL AND NON-COMMERCIAL USE OF A CONSUMER TO (i) ENCODE VIDEO IN COMPLIANCE WITH THE VC-1 STANDARD ("VC-1 VIDEO") AND/OR (ii) DECODE VC-1 VIDEO THAT WAS ENCODED BY A CONSUMER ENGAGED IN A PERSONAL AND NON-COMMERCIAL ACTIVITY AND/OR WAS OBTAINED FROM A VIDEO PROVIDER LICENSED TO PROVIDE VC-1 VIDEO. NO LICENSE IS GRANTED OR SHALL BE IMPLIED FOR ANY OTHER USE. ADDITIONAL INFORMATION MAY BE OBTAINED FROM MPEG LA, L.L.C. SEE [HTTP://WWW.MPEGLA.COM](http://www.mpegla.com)
- THIS PRODUCT IS LICENSED UNDER THE AVC PATENT PORTFOLIO LICENSE FOR THE PERSONAL USE OF A CONSUMER OR OTHER USES IN WHICH IT DOES NOT RECEIVE REMUNERATION TO (i) ENCODE VIDEO IN COMPLIANCE WITH THE AVC STANDARD ("AVC VIDEO") AND/OR (ii) DECODE AVC VIDEO THAT WAS ENCODED BY A CONSUMER ENGAGED IN A PERSONAL ACTIVITY AND/OR WAS OBTAINED FROM A VIDEO PROVIDER LICENSED TO PROVIDE AVC VIDEO. NO LICENSE IS GRANTED OR SHALL BE IMPLIED FOR ANY OTHER USE. ADDITIONAL INFORMATION MAY BE OBTAINED FROM MPEG LA, L.L.C. SEE [HTTP://WWW.MPEGLA.COM](http://www.mpegla.com)
- THIS PRODUCT IS LICENSED UNDER THE MPEG-4 VISUAL PATENT PORTFOLIO LICENSE FOR THE PERSONAL AND NON-COMMERCIAL USE OF A CONSUMER FOR (i) ENCODING VIDEO IN COMPLIANCE WITH THE MPEG-4 VISUAL STANDARD ("MPEG-4 VIDEO") AND/OR (ii) DECODING MPEG-4 VIDEO THAT WAS ENCODED BY A CONSUMER ENGAGED IN A PERSONAL AND NON-COMMERCIAL ACTIVITY AND/OR WAS OBTAINED FROM A VIDEO PROVIDER LICENSED BY MPEG LA TO PROVIDE MPEG-4 VIDEO. NO LICENSE IS GRANTED OR SHALL BE IMPLIED FOR ANY OTHER USE. ADDITIONAL INFORMATION INCLUDING THAT RELATING TO PROMOTIONAL, INTERNAL AND COMMERCIAL USES AND LICENSING MAY BE OBTAINED FROM MPEG LA, L.L.C. SEE [HTTP://WWW.MPEGLA.COM](http://www.mpegla.com)

Attaching the stand

- Before attaching (or detaching) the stand, unplug the AC cord from the AC outlet.
- Before performing work spread cushioning over the base area to lay the TV on. This will prevent it from being damaged.

1 Confirm the screws supplied with the TV.

Screws (x 4)



2 Insert the stand assembly into the openings on the bottom of the TV. (①)

3 Insert and tighten the screws into the holes on the rear of the TV. (②)

LC-40SA5200X

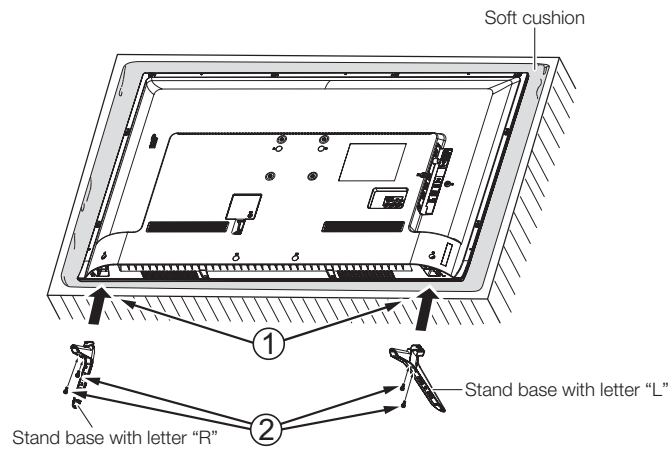

LC-50SA5200X

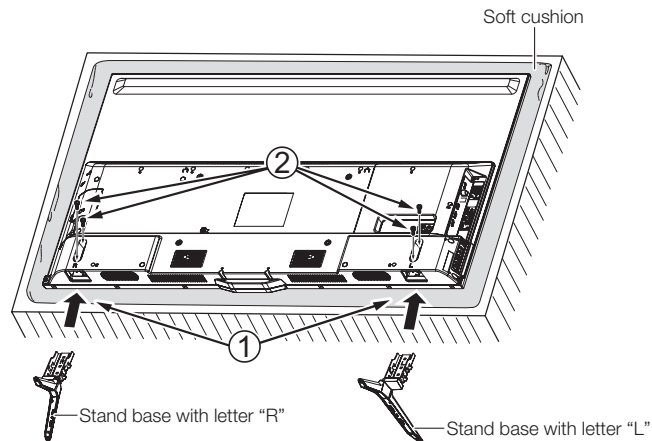

NOTE

- To detach the stand, perform the steps in reverse order.
- Do not attach or detach the stand without holding it. Doing so can cause the stand to fall, resulting in serious personal injuries as well as damage to the stand.

Antenna connection

Connect antenna cable to the antenna terminal

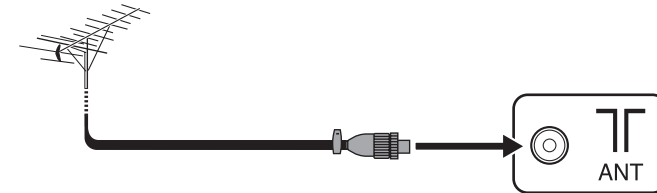

If your outdoor antenna uses a 75-ohm coaxial cable with a standard DIN45325 plug (IEC 169-2), plug it into the antenna jack at the rear of the set.

CAUTION

- **TO PREVENT RISK OF ELECTRIC SHOCK, DO NOT TOUCH UN-INSULATED PARTS OF ANY CABLES WITH THE AC CORD CONNECTED.**

NOTE

- Place the TV close to the AC outlet, and keep the power plug within reach.

- The illustrations used throughout this manual are based on LC-50SA5200X.
- Please refer to page 11 for illustration of LC-40SA5200X.

Connecting external devices

You can connect many types of external equipment to your TV, like a VCR, game console, camcorder, DVD player, Digital TV STB (Set Top Box) and PC. To view external source images, select the input source from **INPUT** on the remote control unit or **INPUT** on the TV.

CAUTION

- To protect all equipment, always turn off the TV before connecting to a VCR, game console, camcorder, DVD player, Digital TV STB (Set Top Box), PC or other external equipment.
- Refer to the relevant operation manual (VCR, DVD player, etc.) carefully before making connections.

Connecting a VCR, game console or camcorder

A VCR, game console, camcorder and some other audiovisual equipment can be conveniently connected using the INPUT 3 terminal.

When using composite cable (commercially available)

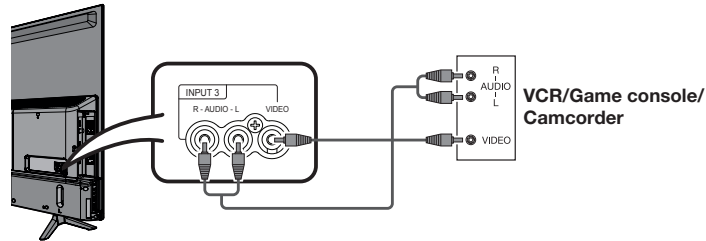

Connecting a DVD player/Digital TV STB (Set Top Box)

You can use the INPUT 1 (HDMI/ARC)/INPUT 2 (HDMI) or INPUT 3 terminals when connecting to a DVD player/Digital TV STB (Set Top Box) and other audiovisual equipment.

When using HDMI-certified cable (commercially available)

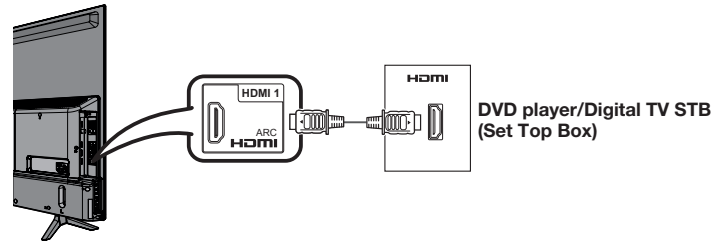

Connecting a PC

You can use the INPUT 1 (HDMI/ARC)/INPUT 2 (HDMI) terminal when connecting to a PC.

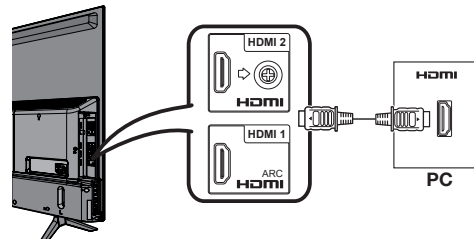

- The illustrations used throughout this manual are based on LC-50SA5200X.
- Please refer to page 11 for illustration of LC-40SA5200X.

Connecting external devices (Continued)

Connecting a USB device

Connect a USB device to the TV.

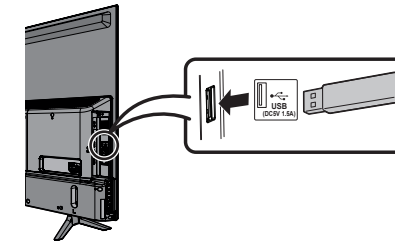

CAUTION

- Do not disconnect a USB device from the TV while transferring files, when a screen is in "USB" mode.
- The illustrations used throughout this manual are based on LC-50SA5200X.
- Please refer to page 11 for illustration of LC-40SA5200X.

Remote control unit

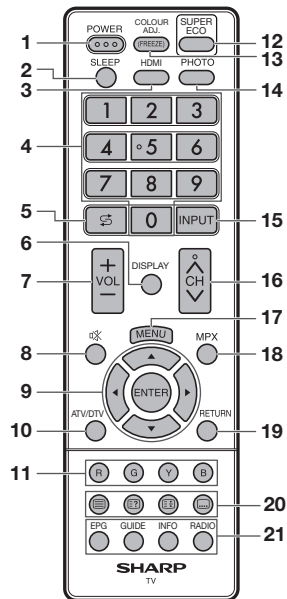

- 1 POWER (STANDBY/ON)**
To switch the power on and off. (See page 12.)
- 2 SLEEP**
Set the Sleep timer.
0 hr. 30 min. → 1 hr. 00 min. → 1 hr. 30 min.
Off ← 2 hr. 30 min. ← 2 hr. 00 min.
- 3 HDMI**
Select the HDMI input mode.
- 4 0 - 9**
Set the channel.
TELETEXT mode: Set the page. (See page 24.)
- 5 (Flashback)**
Press to return to the previous selected channel or external input mode.
- 6 DISPLAY**
Display the channel or input information.
- 7 VOL + /VOL -**
Set the volume.
(VOL +) Increase the volume.
(VOL -) Decrease the volume.

- 8 (Mute)**
Press → Mutes sound.
Press again → Restores sound.
Mute will be cancelled after 30 minutes. However, the TV will not suddenly output loud sound as the volume level will be set to 0 automatically. Increase the volume level by pressing VOL +.
- 9 (Cursor)**
Select a desired item on the setting screen.
ENTER
Execute a command.
- 10 ATV/DTV**
Press to access analogue and digital TV mode. (See page 21.)
- 11 Colour (Red/Green/Yellow/Blue)**
The coloured buttons are correspondingly used to select the coloured items on the screen.
TELETEXT mode: Select a page. (See page 24.)
- 12 SUPER ECO**
Reduce overall power consumption based on user preferences. (See page 23.)
- 13 COLOUR ADJ. (FREEZE)**
Freeze a motion picture on the screen and adjust the colour tone of the still image. (See page 24.)
- 14 PHOTO**
Display your pictures directly on the TV screen. (See page 26.)
- 15 INPUT (INPUT SOURCE)**
Select an input source.
- 16 CH / CH V**
TV input mode: Select the channel.
(CH /) Increase the channel number.
(CH V) Decrease the channel number.
TELETEXT mode: Select a page. (See page 24.)
- 17 MENU**
Display the menu screen.
- 18 MPX**
Select the sound multiplex mode.
- 19 RETURN**
MENU mode: Return to the previous menu screen.
- 20 (TELETEXT), (Reveal hidden for TELETEXT), (Hold), (SUBTITLE for TELETEXT)**
Use for TELETEXT mode. (See page 24.)
- 21 EPG**
DTV mode: To display EPG (Electronic Programme Guide) screen. (See page 23.)
GUIDE
DTV mode: Display the programme channel list. (See page 21.)
INFO
DTV mode: Display the programme information. (See page 21.)
RADIO
Press to access RADIO mode. (See page 21.)

Remote control unit (Continued)

Inserting the batteries

Before using the TV for the first time, insert two "AAA" size batteries (supplied). When the batteries become depleted and the remote control fails to operate, replace the batteries with new "AAA" size batteries.

- 1** Open the battery cover.
- 2** Insert the two supplied "AAA" size batteries.
- 3** Close the battery cover.

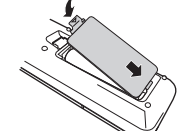
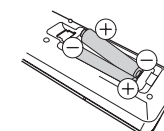
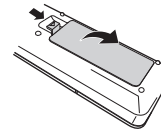

- Place batteries with their terminals corresponding to the (+) and (-) indications in the battery compartment.

CAUTION

- Batteries (battery pack or batteries installed) shall not be exposed to excessive heat such as sunshine, fire or the like.

Part names

TV (Front)

LC-40SA5200X

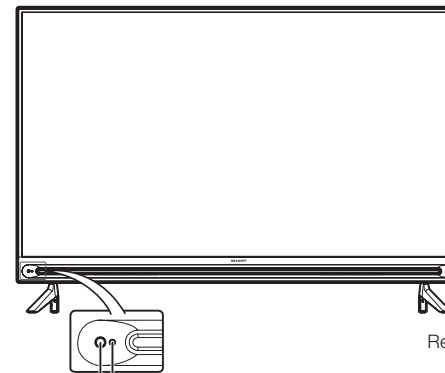

LC-50SA5200X

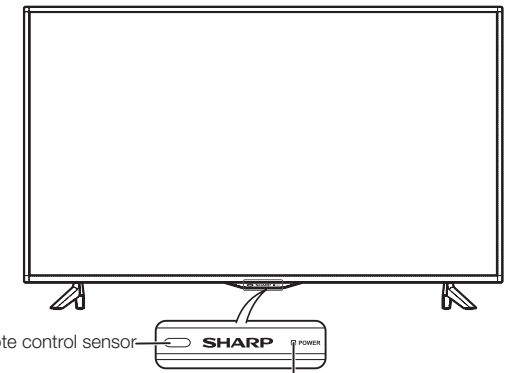

Remote control sensor

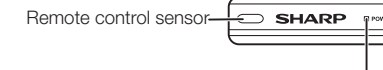

POWER indicator

Light off	Power off.
Lighted (Red)	The TV is in standby mode.
Lighted (Green)	The TV is on.

Part names (Continued)

TV (Rear)

LC-40SA5200X

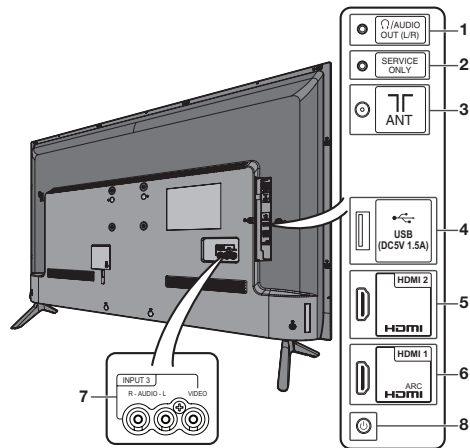

- 1 Ω /AUDIO OUT (L/R) terminal
- 2 SERVICE ONLY terminal**
- 3 Antenna input terminal
- 4 USB terminal*
- 5 INPUT 2 (HDMI) terminal
- 6 INPUT 1 (HDMI/ARC) terminal
- 7 INPUT 3 terminals
- 8 One Button Key

One Button Key	Functions Descriptions
Single Press	On/Off (No OSD display)
Long Press	Sub-menu display on TV screen (10s timeout)
Function During Menu	<ol style="list-style-type: none"> 1. INPUT* 2. CH \wedge* 3. CH \vee* 4. VOL +* 5. VOL -*

- * Single Press: Scroll Down
* Hold Press: Select Item

LC-50SA5200X

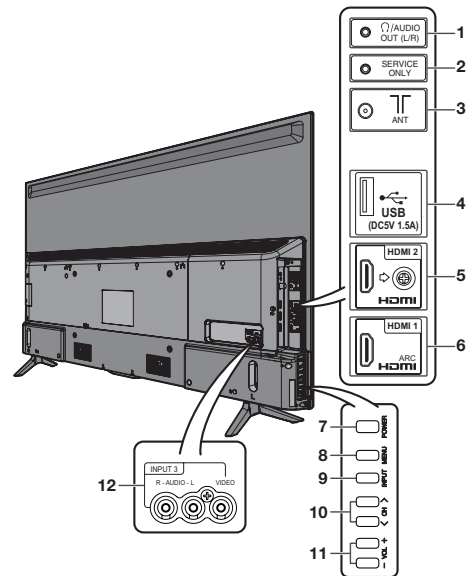

- 1 Ω /AUDIO OUT (L/R) terminal
- 2 SERVICE ONLY terminal**
- 3 Antenna input terminal
- 4 USB terminal*
- 5 INPUT 2 (HDMI) terminal
- 6 INPUT 1 (HDMI/ARC) terminal
- 7 **POWER** (On/Off) button
- 8 **MENU** button
- 9 **INPUT** button
- 10 Channel up (\wedge)/down (\vee) buttons
- 11 Volume up (+)/down (-) buttons
- 12 INPUT 3 terminals

* USB terminal use for USB media player. (See page 26.)

** Usually do not connect anything to this terminal as it reserved only for service personnel.

- The illustrations and on-screen displays in this operation manual are for explanation purposes and may vary slightly from the actual operations.
- Some features differ depending on the selected country.

Turning the TV on/off

Turning on/off the power

- **To turn on the power**
Press **POWER** on the TV or remote control. (After a few seconds, an image appears with sound.)
- **To turn off the power**
Switch it off by pressing **POWER** on the TV or remote control.

NOTE

- If you are not going to use this TV for a long period of time, be sure to remove the AC cord from the AC outlet.
- Minor power is consumed when the unit is in standby mode.

Easy setup

When the TV powers on for the first time after purchase, the initial auto installation wizard appears. Follow the menu and make the necessary settings one after another.

- 1 Press **POWER** on the remote control.
 - The initial auto installation wizard appears. Press **ENTER** to start the wizard.
- 2 Press $\blacktriangle/\blacktriangledown$ to select the desired language, and then press **ENTER**.
Press $\blacktriangle/\blacktriangledown$ to select your country channels in "Location", and then press **ENTER**.
Press $\blacktriangle/\blacktriangledown$ to select "HOME" or "Store", and then press **ENTER**.

HOME:

 - "STANDARD" will be the default value for the "AV mode" setting.

Store:

 - "DYNAMIC (Fixed)" will be the default value for the "AV mode" setting. If the "AV mode" is changed, the TV will automatically switch back to "DYNAMIC (Fixed)" when there is no further change to TV setting for 30 minutes.
 - To change the Store mode to HOME mode, please refer to page 16 to reset the unit.
- 3 Press $\blacktriangle/\blacktriangledown$ to select "DTV", "ATV" or "DTV + ATV" in "Search type", and then press **ENTER**.
 - Auto installation will be executed.
 - You do not need to do anything during the auto search.
 - If you select "Others" country, some of DTV channel may not tune properly.
 Press $\blacktriangle/\blacktriangledown$ to select "Start" or "Cancel", and then press **ENTER** for searching receivable channels.

NOTE

- In the setting of some country, selecting of "DTV", "ATV" or "DTV + ATV" may not be shown.
- A region or service selection screen may display depending on the country settings or cable providers selections. Follow the screen prompts to make the selections.

Digital setting

You can reconfigure DTV services settings automatically or manually.

- 1 Press **MENU** and the MENU screen displays.
- 2 Press $\blacktriangle/\blacktriangledown$ to select "Initial setup".
- 3 Press $\blacktriangle/\blacktriangledown$ to select "Digital setting", and then press **ENTER**. If you have already set the password, enter it here.
 - See "Child lock" to set password.
- 4 Press $\blacktriangle/\blacktriangledown$ to select the desired menu item, and then press **ENTER**.

Auto search

Use this menu to add new services automatically after auto installation has been completed.

- Press $\blacktriangle/\blacktriangledown$ to select "DTV" or "DTV+ATV".

Manual search

Add new services within a specified channel band.

- Press $\blacktriangle/\blacktriangledown$ to find the channel and then press **ENTER**.

Signal information

Use this menu to check signal information depends on receiving channel.

Analogue setting

You can reconfigure the TV channel settings automatically or manually using **Auto search** or **Manual adjust**.

Auto search

You can also automatically search by performing the procedure below. This is the same function as programme auto search in auto installation.

- 1 Press **MENU** and the MENU screen displays.
- 2 Press **◀/▶** to select "Initial setup".
- 3 Press **▲/▼** to select "Analogue setting", and then press **ENTER**. If you have already set the password, enter it here.
 - See "Child lock" to set password.
- 4 Press **▲/▼** to select "Auto search", and then press **ENTER**. You do not need to do anything during the auto search. Press **MENU** to exit.

Manual adjust

You can set some channel items manually.

- 1 Repeat steps 1 to 3 in **Auto search**.
- 2 Press **▲/▼** to select "Manual adjust", and then press **ENTER**.
- 3 Press **▲/▼** to select your desired item, press **ENTER**, and then press **▲/▼** or **◀/▶** to adjust the settings.

Item	Description
Current CH	Select the channel you want to edit. <ul style="list-style-type: none"> • Selected channel will be automatically reflected in the background.
Sound system	Select the optimum sound system (Broadcasting system) to receive. (B/G, D/K, I, M)
Colour system	Select the optimum colour system to receive. (NTSC 3.58, NTSC 4.43, PAL, SECAM)
Search	Start searching from current channel. <ul style="list-style-type: none"> • Press ◀/▶ to auto search.
Fine-tune	Tune the frequency of the stored channel to your desired position. <ul style="list-style-type: none"> • Instead of pressing ◀/▶, you can set by directly entering the frequency number of the channel with 0-9 and then press ENTER to adjust while checking the background picture as a reference.

NOTE

- The frequency shown below the On-Screen Display shows the real-time frequency of the displayed channel.

Menu operation



- 1 Press **MENU** and the MENU screen displays.
- 2 Press **◀/▶** to select the desired menu. (Initial setup, Information, Picture settings, Audio settings, System options)
- 3 Press **▲/▼** to select the desired menu item. Press **ENTER** to proceed if necessary.
- 4 Press **▲/▼** or **◀/▶** to select the desired item or adjust the item to the desired level. Press **ENTER** if necessary.
- 5 Press **RETURN** as necessary to return to the previous MENU. Press **MENU** to exit the MENU.

Initial setup

Time setting

This function can display the time, data on screen and channel's timetable with updated time info.

- 1 Repeat steps 1 and 2 in **Menu operation**.
- 2 Press **▲/▼** to select "Time setting", and then press **ENTER**.
- 3 Press **▲/▼** to select the desired menu item, and then press **ENTER**.

Time adjustment

This function allows you to set the clock manually.

NOTE

- If you select "On" in "Auto synchronization" the TV will try to get the time for the broadcast. It will only be selectable when "Auto synchronization" is set to "Off".
- "Time zone" enables you to select your local time zone. It will only be selectable when "Auto synchronization" is set to "On".

Time display

This function allows you to display the clock time in the lower-right corner of the screen.

Selected item	Description
Off	Hides the clock time.
On	Displays the clock time.

Language

Select from among 12 languages: English, Simplified Chinese, Arabic, French, Portuguese, Russian, Persian, Thai, Vietnamese, Indonesian, Hebrew and Hindi.

Child lock

Allows you to use a password to protect certain settings from being accidentally changed.

Lock system

If the password is not set, the "Lock system" is invalid.

Please make sure the "Lock system" is set to "On" before the Child lock is set. (Off, On).

Set password

- 1 Repeat steps 1 and 2 in **Menu operation**.
- 2 Press **▲/▼** to select "Child lock", and then press **ENTER**.
- 3 If you have already set the password, enter it here.
- 4 Enter the 4-digit number as a password using **0-9**.
- 5 Enter the same 4-digit number as in step 4 to confirm.

NOTE

- To view a locked channel, you must enter a password. When you select a locked channel, "Child lock has been activated" is displayed.
- Press **ENTER** to display the password input window.

Block programme

The "Block programme" can be select after "Lock system" is set to "On".

Initial setup (Continued)

Parental rating

This function allows TV channels to be restricted. It prevents children from watching violent or sexual scenes that may be considered inappropriate.

- Repeat steps 1 to 3 in **Set password**.
- Press ▲/▼ to select "Parental rating", and then press **ENTER**.
- Press ▲/▼ to select your desired rating, and then press **ENTER**.

Selected item	Description
Off	Cancel the blocking.
Age xx years	Select desired age to block. (Example) If age 14 is selected, programmes rated for ages of 15 or more are blocked.

Child screen timer

This function allows you to set a screen viewing time limit. When counter reach the time you already set, it will display a warning/information screen. (Off, 1 hour, 2 hours, 3 hours)

NOTE

- This warning/information screen will keep display at the center until user turn off the TV and "Child screen timer" will automatically set to "Off".
- Once "Child screen timer" is selected, "COMFORT MODE" is automatically turned "On".

Programme edit

Use this menu to set up a channel individually.

- Repeat steps 1 and 2 in **Menu operation**.
- Press ▲/▼ to select "Programme edit", and then press **ENTER**. If you have already set the password at "Child lock", enter it here.
 - See page 14 to set password.
- Press ▲/▼ to select the channel you want to edit, press ▲/▼ to select item, and then press **ENTER** and press **RETURN** to exit.

Selected item	Description
Erase	Channels can be erased individually. Press ▲/▼ to select "Yes" or "No", and then press ENTER to erase the selected channel.
Label	You can change channel names individually. Maximum 5 alphanumeric can be input. Press ENTER to start labelling. Press ▲/▼ to select a character, press ◀/▶ to select next character, and then press ENTER to save.
Sort	Channel position can be sorted freely.
Skip	Channels can be skip by select "Off" or "On".

Initial setup (Continued)

Input settings

HDMI auto view (HDMI input mode only)

Selected item	Description
Enable/Disable	Set whether or not to use the Auto Selection of WIDE MODE based on signal recognition received from the HDMI signal.

Digital audio

This function allows you to select the digital audio signal type. (Off, Bitstream, PCM)

Audio output select

You can select which device is used for outputting audio.

Option	Description
Headphone	Output audio through headphones.
Audio out	Output audio through an A/V receiver or surround audio controller.

NOTE

- If you select "Headphone" when a cable is inserted in the AUDIO output terminal, the TV speakers are muted and all Audio menu items cannot be adjusted.
- If you select "Audio out", sound via the AUDIO output terminal is not adjustable and constantly outputs.

Regarding the headphone jack

- Use headphones with a stereo mini plug (ϕ 3.5 mm).
- Be sure to unplug headphones from the jack when they are not in use.

Volume display when headphones are plugged in



CAUTION

- AUDIO output terminal is also used for headphones. Reduce the volume before using headphones. Overwhelming sound may damage your hearing.

Colour system

You can change the colour system to one that is compatible with the image on the screen. (Auto, PAL, SECAM, NTSC 3.58, NTSC 4.43, PAL-60)

NOTE

- If "Auto" is selected, colour system for each channel is automatically set. If an image does not display clearly, select another colour system (e.g. PAL, NTSC 4.43).
- "Colour system" is selectable only when inputting a composite signal.

Link setup

Link operation

Using the HDMI CEC (Consumer Electronics Control) protocol, with Link operation you can interactively operate compatible system equipment (e.g. DVD), by connecting the link operation-compatible devices with HDMI-certified cables to the TV.

Link operation allows you to operate the HDMI-connected equipment and the TV by using a single remote control unit. (Off, On)

Auto power on

If this is activated, the one touch play function is enabled. While the TV is in standby mode, it automatically turns on and plays back the image from the HDMI source. (Off, On)

Speaker select

You can select to listen to the TV sound only from the LINK-compatible audio system. (Internal speakers, External device)

Audio return channel

If this function is set to "Auto", the TV can send audio data for video content shown on the TV to a connected audio device with just one ARC-compatible cable. Using this function eliminates the need to use a separate digital or analogue audio cable. (Off, Auto)

Connection for using "Audio return channel"

You need to use ARC-compatible cables/devices and connect to the INPUT 1 terminal to activate this function.

NOTE

- The ARC (Audio return channel) function works only when using the INPUT 1 terminal.
- When you use an audio system compatible with the ARC function of the TV, you do not need to connect an optical audio cable to the TV.

Reset

If complex adjustments are made and the settings cannot be restored to normal, you can reset the settings to the factory preset values.

NOTE

- If you execute "Reset", all the settings such as "Picture settings", "Audio settings" and "Initial setup" will be reset to the factory preset values.

Information

Identification

You can check the current version of the software on the screen.

Software update

This is used to upgrade the system software to enhance the TV functions.

Manual update

Updates the software using a USB memory device containing the update file.

Auto update setting

OAD update

- This function is for automatically download the data for the version update software over digital broadcasts when the "OAD update" is set to "On".
- To download, follow the instructions when the download message appears during a digital broadcast.
- Once the software upgrade is done, the TV will automatically go to standby state with Red LED.

OAD scan

- This function is for manually download the data for the version update software over digital broadcasts.

CAUTION

- **Do not disconnect the AC cord when the software upgrade is in progress, as this may cause the upgrade to fail. If problem arises ask a qualified service personnel before the software upgrade period expires.**

Software license

You can read the software license on the screen.

Picture settings

Selecting a preset AV mode

"AV mode" gives you several viewing options to choose from to best match the system environment, which can vary due to factors like room-brightness, type of programme watched or the type of image input from external equipment.

- 1 Press **MENU** and the MENU screen displays.
- 2 Press **◀/▶** to select "Picture settings".
- 3 Press **▲/▼** to select "AV mode", and then press **ENTER**.

Selected item	Description
STANDARD	For a highly defined image in a normally bright room.
MOVIE	For a movie.
PC	For PC (Available only when inputting an HDMI or PC signal).
USER	Allows you to customise settings as desired. You can set the mode for each input source.
DYNAMIC	For a clear-cut image emphasising high contrast for sports viewing.
DYNAMIC (Fixed)	Changes the image and sound settings to the factory preset values. No adjustments are allowed.
COMFORT MODE	Reduce the blue light of the TV.
SUPER ECO	Reduce the backlight brightness.

NOTE

- You can select a different AV mode item for each input mode. (For example, select STANDARD for TV input and DYNAMIC for VIDEO input.)

Adjustment items

Selected item	◀ button	▶ button
Backlight	The screen dims	The screen brightens
Contrast	For less contrast	For more contrast
Brightness	For less brightness	For more brightness
Colour	For less colour intensity	For more colour intensity
Tint	Skin tones become reddish	Skin tones become greenish
Sharpness	For less sharpness	For more sharpness

Picture settings (Continued)

Advanced

This TV provides various advanced functions for optimising the picture quality.

Digital noise reduction

Reduces noise on screen and produces a clearer video image. (Off, Low, Medium, High, Auto)

Eagle View*

"Eagle View" technology produces a sharp picture from the original moving picture. (Off, On)

AquoMotion Lite*

"AquoMotion Lite" technology provides superior solutions for display picture quality removing motion blur. (Off, High, Advance)

NOTE

- * This effect is greater on fast moving images.
- * This function will have no effect in the following cases.
 - 1) The type of signal received is a PC signal.
 - 2) An OSD is being displayed.
 - 3) Teletext is activated.
- * If images appear blurred or flickering, set to "Off".
- * "Picture settings" cannot be changed during "DYNAMIC (Fixed)" mode.
- * For resetting all "Picture settings" items to factory preset values, press **▲/▼** to select "Reset", press **ENTER**, press **▲/▼** to select "Yes", and then press **ENTER**.

Audio settings

You can adjust the sound quality to your preference with the following settings.

Selected item	◀ button	▶ button
Treble	For weaker treble	For stronger treble
Bass	For weaker bass	For stronger bass
Balance	Decrease audio from the right speaker	Decrease audio from the left speaker

Surround

The surround function produces surround effect from the speakers. (Off, On)

Bass enhancer

This function allows you to enjoy bass-enhanced sound.

Selected item	Description
On	Bass enhancer function is on.
Off	Outputs the normal sound.

NOTE

- If distorted bass sound is heard, set to "Off".

Auto volume

Different sound sources, fairly often do not have the same volume level, for example the changing from movie to the advertisements. Auto volume solves this problem and equalises the volume levels. (Off, On)

NOTE

- For resetting all "Audio setting" items to factory preset values, press **▲/▼** to select "Reset", press **ENTER**, press **▲/▼** to select "Yes", and then press **ENTER**.

System options

Power control

Power control setting allows you to save energy.

No signal off

You can set the TV to automatically power off in about 15 minutes after the TV goes into a state of receiving no programme signals. (Enable, Disable)

- Five minutes before the power shuts down, the remaining time displays every minute.

NOTE

- When a TV programme finishes, and the TV receives signal input, this function may not operate.

No operation off

You can set the TV to automatically power off when no TV operation is performed for more than 3 hours. (Disable, 3 hours, 30 min.)

- Five minutes before the power shuts down, the remaining time displays every minute.

View option

Wide mode

You can manually select the size of a picture appeared on your screen.

Selectable picture size varies with the type of signal received.

Press ▲/▼ while the wide mode menu displays on the screen.

- As you toggle down the options, each mode is immediately reflected on the TV.

Item (for SD [Standard-Definition] signals)	
Normal	Keeps the original aspect ratio in a full screen display.
Zoom 14:9	For 14:9 letterbox pictures. A thin side bar appears on each side, and you may also see bars on the top and bottom with some programmes.
Panorama	In this mode, the picture is stretched toward each side of the screen. The picture may appear similar to "Full" depending on broadcast signals.
Full	For 16:9 squeeze pictures.
Cinema 16:9	For 16:9 letterbox pictures. Bars may appear on the top and bottom with some programmes.
Cinema 14:9	For 14:9 letterbox pictures. Bars may appear on the top and bottom with some programmes.

Item (for HD [High-Definition] signals)	
Full	Displays with an overscan image. Crops all sides of screen.
Underscan	Display with an Underscan image only when receiving a 720p signal. Display with the High-Definition image adjusted optimally. Noise may appear on the edge of the screen with some programmes.
Dot by Dot	Displays an image with the same number of pixels on the screen.

NOTE

- "Zoom 14:9" and "Cinema 14:9" will appear only for TV mode.
- Some items do not appear depending on the type of received signal.

System options (Continued)

4:3 mode (DTV input mode only)

The 4:3 mode allows you to select between "Normal" and "Full".

Selected item	Description
Normal	Normal range keeping 4:3 or 16:9 aspect ratio.
Full	Wide image without side bars.

4:3 screen types

4:3 mode "Normal"



4:3 mode "Full"



Auto wide (DTV input mode only)

The "Auto wide" allows the TV to switch automatically among the different picture size. (Off, On)

NOTE

- Use "Wide mode" if an image does not switch to the appropriate picture size. When the broadcast signal contains no aspect ratio information, the function will not work even if enabled.

Change audio

MPX

Allows you to change the audio when multiple audio is available for the programme you are watching. (Auto, MONO)

Bilingual

Select from among 3 kinds of mode: DUAL I, DUAL II and DUAL I + II.

Audio only

When listening to music from a music programme, you can turn the screen off and enjoy audio only.

Selected item	Description
Off	Both screen images and audio are output.
On	Audio is output without screen image.

NOTE

- When you make operations that change the picture on the TV such as by changing the input source, the "Audio only" function is set to "Off".

Audio description (DTV input mode only)

This function allows you to adjust volume output of audio description if the TV receives a signal including audio description.

Switching the multi audio languages

Each time you press **MPX** on the remote control, the audio language switches.

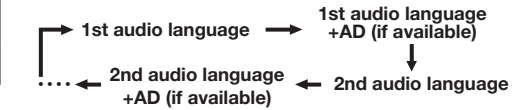

NOTE

- This function is valid only if broadcaster is transmitting audio description.

Hearing impaired (DVB subtitle)

Each time you press on the remote control, the subtitle switches when the broadcast contains subtitle information.

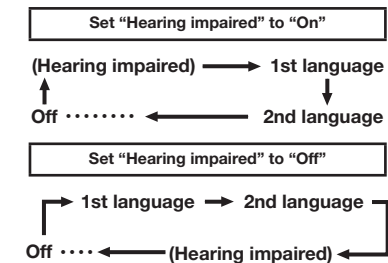

NOTE

- This function is valid only if broadcaster is transmitting multilingual subtitles.

Digital audio language

Set up to two preferred multi audio languages to display if the audio languages are available. (1st language, 2nd language)

NOTE

- If audio for the selected languages is not included in a received broadcast, audio will not be output for that language.

Change subtitle

You can display subtitles for the hearing impaired in the Teletext broadcast if the subtitle languages are available. (1st language, 2nd language)

NOTE

- If subtitles for the selected language are not included in a received broadcast, subtitles will not be shown for that language.

System options (Continued)

Text language

Select from among 5 kinds of language: West Europe, East Europe, Cyrillic, Arabic and Farsi.

NOTE

- Teletext can display only when it is sent by a network. Not used to convert between languages.

Demo (store mode only)

When "Store mode" is set to "On", after all the settings are completed, the Feature demo screen is displayed if there is no operation for 30 seconds.

Quick start mode

When this function is activated, you can reduce the TV's start-up time or even let the TV in standby mode start displaying images and so on via the connected equipment on the network. (Off, On).

NOTE

- Setting "Quick start mode" to "On" consumes more power.

Programme Guide

You can check the current channel list of DTV/ATV respectively.

- Press **GUIDE** to display the programme channel list.
- Press **▲/▼** to select your desired programme, and then press **ENTER**.
- Press **RETURN** or **GUIDE** to exit.

Info

While watching DTV you can check the extended programme information on the screen using **INFO** on the remote control.

General INFO screen

- Station name
- Title
- Date
- Time for the current programme
- Age
- Genre
- Programme info

NOTE

- If there is more information, pressing **▲/▼** allows you to go to the next page or return to the previous page.
- You can cancel this info by pressing **INFO**.

ATV/DTV/RADIO buttons

Use the following buttons on the remote control to operate the menu.

ATV/DTV: Press to switch between ATV and DTV mode. After switching from ATV or DTV, radio or external input mode to ATV and DTV mode, the TV jumps to the most recently viewed ATV and DTV channel.

RADIO: Press to switch from DTV to radio mode. The TV will jump to the most recently tuned radio channel.

When you watch the TV for the first time
When the TV powers on for the first time after purchase, perform the auto installation.

ATV (Analogue TV)

You can run the auto installation to set channels automatically.

- To watch the analogue TV, select "ATV" from "Search type" in Easy setup menu. (See page 12.)
- After setting the channels, you can select a channel using **CH▲/▼** or **0-9** on the remote control unit. (See page 9.)

DTV (Digital TV)

When the TV accesses to DTV mode for the first time, you need to run the auto search. To scan all available services in your area, follow the procedures below.

- To watch the DTV broadcasts, select "DTV" from "Search type" in Easy setup menu. (See page 12.)
- After setting the channels, you can select a channel using **CH▲/▼** or **0-9** on the remote control unit. (See page 9.)

Switching the analogue audio format

You can switch between multiple audio modes when watching a multiple audio or stereo broadcast programme.

PAL broadcast signal

In the NICAM TV broadcasts

When receiving a stereo signal

Each time you press **MPX**, the mode switches between NICAM STEREO and MONO.



When receiving a bilingual signal

Each time you press **MPX**, the mode switches among NICAM DUAL I, NICAM DUAL II, NICAM DUAL I + II and MONO.

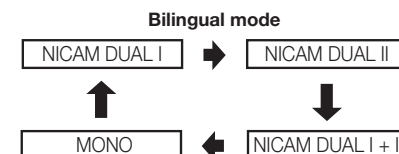

When receiving a monaural signal

Each time you press **MPX**, the mode switches between NICAM MONO and MONO.



In the TV mode of A2 TV broadcasts

When receiving a stereo signal

Each time you press **MPX**, the mode switches between STEREO and MONO.



When receiving a bilingual signal

Each time you press **MPX**, the mode switches among DUAL I, DUAL II and DUAL I + II.

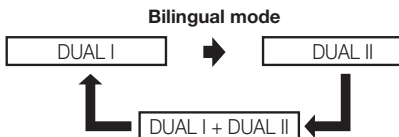

NTSC broadcast signal

When receiving a Stereo + SAP signal

Each time you press **MPX**, the mode switches between ST (SAP), SAP (ST) and MONO.

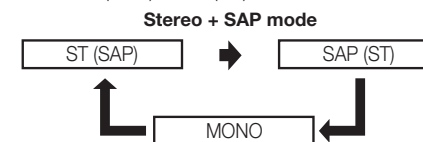

When receiving a monaural signal + SAP signal

Each time you press **MPX**, the mode switches between MONO and SAP.

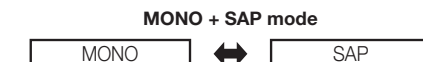

When receiving a stereo signal

Each time you press **MPX**, the mode switches between STEREO and MONO.



NOTE

- On-screen display in this operation manual are for explanation purpose and may vary slightly from actual on-screen display.

EPG

What is an EPG?

An "EPG (Electronic Programme Guide)" is a programme schedule, which is displayed on the TV screen. The EPG is broadcasted together with DTV. The TV screen shows the EPG when the viewer presses **EPG** on the remote control, provided that the TV is receiving the digital broadcasting signal. The EPG enables you to search for a programme, do timer view the programme schedule in detail.

Basic Operation

■ Display the EPG screen

- ① Press **EPG**.
- ② Press **▲/▼** to select different programme time information.
- ③ Press **◀/▶** to change the day selection.

■ Close the EPG screen

- ④ Press **EPG** again or **RETURN** to exit.

Reminder timer setting

You can schedule a reminder for future programmes. Channel will automatically change on time as scheduled.

- 1 Press **EPG**.
- 2 Press **▲/▼** to select the programme you want to watch.
- 3 Press **R** to set reminder time.
- 4 Press **ENTER** to save reminder timer.
 - "Timer save success" will display.

NOTE

- "Timer overlay" will display if same time is set twice.
- "Timer past" will display if past time is set.

- 5 Press **Y** to display the reminder schedule list.
- 6 Press **RETURN** or **EPG** to exit.

Viewing the reminder schedule list

- 1 Press **EPG**.
- 2 Press **Y** to display the reminder schedule list.
- 3 Press **▲/▼** to display next or previous screen.
- 4 Press **RETURN** or **EPG** to exit.

Cancelling the reminder timer setting

- 1 Press **EPG**.
- 2 Press **Y** to display the reminder schedule list.
- 3 Press **▲/▼** to select a programme you want to cancel.
- 4 Press **R** to delete a programme from reminder list.
- 5 Press **RETURN** or **EPG** to exit.

SUPER ECO mode

This function enables you to reduce the backlight brightness in order to decrease the power consumption and increase the backlight life span as shown in the following table.

Selected item	Description
SUPER ECO ON	Reduces the backlight brightness.
SUPER ECO OFF	Normal setting of backlight brightness.

SUPER ECO status will be displayed on the channel information window.

Colour adjustment and still image

Allows you to adjust the colour tone of a still image.

- 1 Press **COLOUR ADJ. (FREEZE)**, the moving image will be captured and colour adjustment screen displays.
- 2 Press **▲/▼/◀/▶** to adjust the colour to your desired setting.

Button	Description
▲	White with greenish tone.
▼	White with reddish tone.
◀	White with bluish tone.
▶	White with yellowish tone.
R	Reveal/hide the setting screen.
G	Set adjustment to last user setting.
B	Close the setting screen and unfreeze image.
ENTER	Save/exit setting.

NOTE

- The colour adjustment screen and still image will automatically goes out after 30 minutes.
- Freeze/Colour adjustment function does not work in USB Photo/Movie playback. It works for HDMI and composite.

Teletext function

What is Teletext?

Teletext broadcasts pages of information and entertainment to specially equipped television sets. News, weather reports, sports information, stock exchange prices and programme previews are among the many services available.

Turning on and off Teletext

- 1 Select a TV channel or external input source providing the Teletext programme.
- 2 Press **☰** to display the Teletext.
- 3 Each time you press **☰**, the screen switches as shown below.

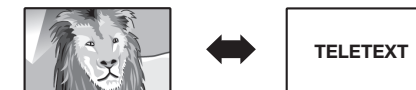

NOTE

- If you select a programme with no Teletext signal, "No Teletext available." is displayed.
- The same message displays during other modes if no Teletext signal is available.

Button functions

Buttons	Description
CH (▲/▼)	Increase or decrease the page number.
Colour (Red/Green/Yellow/Blue)	You can select a group or block of pages displayed in the coloured brackets at the bottom of the screen by pressing the corresponding Colour (Red/Green/Yellow/Blue) on the remote control unit.
0 - 9	Directly select any page from 100 to 899 by using 0 - 9 .
☰ (Reveal hidden for TELETEXT)	To reveal hidden information such as an answer to a quiz.
☰ (Hold)	To stop updating Teletext pages automatically or release the hold mode.
☰ (Subtitle for TELETEXT)	Display the subtitle during Teletext page. <ul style="list-style-type: none"> • Subtitle will not be displayed when the service does not contain subtitle information.

NOTE

- Teletext can display only when it is sent by a network. Not used to convert between languages.

PC compatibility chart

Resolution		Horizontal Frequency	Vertical Frequency	VESA Standard	Analogue (D-Sub)	Digital (HDMI)
VGA	640 × 480	31.5 kHz	60 Hz	✓	✓	✓
SVGA	800 × 600	37.9 kHz	60 Hz	✓	✓	✓
XGA	1024 × 768	48.4 kHz	60 Hz	✓	✓	✓
WXGA	1360 × 768	47.7 kHz	60 Hz	✓	✓	✓
1080P	1920 × 1080	67.5 kHz	60 Hz		✓	✓

DDC is a registered trademark of Video Electronics Standards Association.
 Power Management is a registered trademark of Sun Microsystems, Inc.
 VGA, SVGA, XGA and WXGA are registered trademarks of International Business Machines Corporation.

USB Media Player

Selecting modes

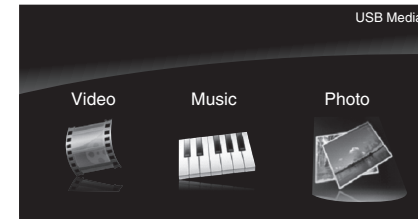

- 1 Press **INPUT** to select the "USB" mode.
- 2 Press **◀▶** to select "Video", "Music" or "Photo", and then press **ENTER**.
- 3 Press **◀▶** to select your USB directory, and then press **ENTER**.
- 4 Press **▲▼/◀▶** to select the desired folder, and then press **ENTER**.

NOTE

- "Wide mode" is fixed during "Photo" and "Music".
- Depending on the USB device, the TV may not be able to recognise the contained data.
- A file name with more than 10 characters may not be displayed all (depending on the character set).
- Files in USB 1.1 devices may not be played properly.
- Operation using USB hubs is not guaranteed.
- The compatibility of USB HDDs may not be guaranteed.

PHOTO slideshow



When you press **PHOTO**, the TV screen will automatically play the photo slideshow.

- If there is no USB drive, the TV will switch to **Selecting modes** screen.
- Photo slideshows will autoplay only for the photos located on the top layer of USB drive. To enable autoplay for photos located in a subfolder, you need to manually select the subfolder, and then press **PHOTO**.

You can select the duration for each photo to display, and also the duration for the slideshow to play.

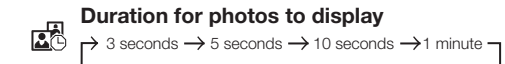

- The TV will automatically power off after the selected playtime ends.

NOTE

- Background music will autoplay during a slideshow only if the music file is located in the same folder with the photo files.
- If you want to stop the photo slideshows, press **RETURN** to exit.

USB Media Player (Continued)

Control panel for photo/music/video mode operations

- Press **B** to display the control panel below.

Button/menu	Description	Photo	Music	Video
ENTER	When selecting a folder icon: Enter this directory. When selecting a thumbnail: Play the selected file.	✓	✓	✓
	Play/Pause.	✓	✓	✓
	Rewind. Each time you press rewind, the speed will change (2x, 4x, 8x, 16x).	-	✓	✓
	Fast-forward. Each time you press fast-forward, the speed will change (2x, 4x, 8x, 16x).	-	✓	✓
*G /	Play the previous file.	✓	✓	✓
*Y /	Play the next file.	✓	✓	✓
RETURN /	Stop playback and return to the list of files.	✓	✓	✓
	Loop. Each time you press ENTER , the mode will switch between Repeat 1 → Repeat All → Repeat None	✓	✓	✓
	Play/cancel the background music.	✓	-	-
	Mute. Press ENTER to toggle between mute and unmute.	-	✓	✓
	Two loop. Press ENTER to set the current playback time starting point. Press ENTER to set the loop end of the current playing time and start loop playback. Press ENTER button to cancel the loop.	-	-	✓
	Slow-forward. Each time you press slow-forward, the speed will change.	-	-	✓
	Step forward. Each time you press ENTER , the picture will change to the next still picture.	-	-	✓
	Rotate clockwise 90°.	✓	-	-
	Rotate counterclockwise 90°.	✓	-	-
	Zoom in an image. Select to display larger image size.	✓	-	-
	Zoom out an image. Select to display smaller image size.	✓	-	-
	Select playback length of a slideshow.	✓	-	-
	Select photo display interval.	✓	-	-
	Slide effect.	✓	-	-
R	Select subtitle to On or Off subtitle.	-	-	✓

NOTE

- * The button **G** and **Y** does not work during control panel display.
- Files in folder which are not related to a selected mode cannot be accessed.
- "Unsupported file" alert will pops up for a selected file of invalid format.

USB Media Player (Continued)

List of files compatible with USB mode

USB device/File system	USB Memory/FAT32
Photo file format	JPEG (.jpg)/PNG/BMP
Music file format (Files may not be playable depending on the bitrate)	MP3 (.mp3) Bitrate: 32 k, 40 k, 48 k, 56 k, 64 k, 80 k, 96 k, 112 k, 128 k, 160 k, 192 k, 224 k, 256 k, 320 kbps

Video file format			
File extension	Container	Video	Audio
*.avi	AVI	H.264 MPEG4 Motion Jpeg	Dolby Digital Plus LPCM ADPCM Dolby Digital
*.mkv	MKV	H.264 MPEG4	Dolby Digital Plus MPEG Dolby Digital
*.mp4 *.mov	MP4	H.264 MPEG4 Motion Jpeg	Dolby Digital Plus MPEG Dolby Digital
*.vob	MPEG2 - PS	MPEG2	LPCM Dolby Digital
.mpg/.mpeg	MPG MPEG	MPEG2 MPEG1	LPCM MPEG Dolby Digital
.ts/.trp/*.tp	TS	H.264 MPEG2	Dolby Digital Plus LPCM MPEG Dolby Digital

Appendix

Troubleshooting

The problems described below are not always caused by malfunctions. Check the TV again before having the TV serviced.

Problem	Possible Solution
• No power.	<ul style="list-style-type: none"> Check if you pressed POWER on the remote control unit. (See page 12.) If the indicator on the TV lights up red, press POWER. Is the AC cord disconnected? Has the power been turned on? (See page 12.)
• Unit cannot be operated.	<ul style="list-style-type: none"> External influences such as lightning, static electricity, etc., may cause improper operation. In this case, operate the unit after first turning the power off the TV or unplugging the AC cord and re-plugging it in after 1 or 2 minutes.
• Remote control unit does not operate.	<ul style="list-style-type: none"> Is battery inserted with polarity (+, -) aligned? (See page 10.) Is battery worn out? (Replace with new battery.) Are you using it under strong or fluorescent lighting? Is a fluorescent light shining on the remote control sensor?
• Picture is cut off.	<ul style="list-style-type: none"> Are screen mode adjustments such as picture size made correctly? (See page 19.)
• Strange colour, light colour, or dark, or colour misalignment.	<ul style="list-style-type: none"> Adjust the picture tone. (See page 17.) Is the room too bright? The picture may look dark in a room that is too bright. Check the colour system setting. (See pages 13 and 16.) Check the HDMI auto view setting. (See page 16.)
• Power is suddenly turned off.	<ul style="list-style-type: none"> The unit's internal temperature has increased. Remove any objects blocking the vent or clean. Check the "Power Control" setting. (See page 19.) Is the sleep timer set? (See page 9.)
• No picture.	<ul style="list-style-type: none"> Is the connection to external equipment correct? (See pages 7 and 8.) Is the correct input selected? Is the "Picture settings" correct? (See pages 17 and 18.) Is the antenna connected properly? (See page 6.) Is "On" selected in "Audio only"? (See page 20.)
• No sound.	<ul style="list-style-type: none"> Is the volume too low? (See page 9.) Make sure that headphones are not connected.
• The TV sometimes makes a cracking sound.	<ul style="list-style-type: none"> This is not a malfunction. This happens when the cabinet slightly expands and contracts according to changes in temperature. This does not affect the TV's performance.

Cautions regarding use in high and low temperature environments

- When the unit is used in a low temperature space (e.g. room, office), the picture may leave trails or appear slightly delayed. This is not a malfunction, and the unit will recover when the temperature returns to normal.
- Do not leave the unit in a hot or cold location. Also, do not leave the unit in a location exposed to direct sunlight or near a heater, as this may cause the cabinet to deform and the LCD panel to malfunction.
Storage temperature: -20°C to +60°C.

Clearing the password

If you forget the password, clear the password using the following procedure.

- Press **MENU** to display the MENU screen, and then press **◀/▶** to select "Initial setup".
- Press **▲/▼** to select "Child lock", and then press **ENTER** and the password input screen display.
- If you enter "3001" using **0-9**, the "Child lock" setting menu will be displayed.
- Enter the 4-digit number as a password using **0-9**. The new password is now set.

Specifications

Item	Model	LC-40SA5200X	LC-50SA5200X
LCD panel		102 cm	126 cm
Resolution		2,073,600 pixels (1920 × 1080)	
Video colour system		PAL/SECAM/NTSC 3.58/NTSC 4.43/PAL 60	
TV function	TV-standard	Analogue	PAL: B/G, D/K, I SECAM: B/G, D/K, K/K1 NTSC: M
		Digital	DVB-T2
	Receiving channel	VHF/UHF	44.25—863.25 MHz
		CATV	S1—S41 ch (including Hyperband)
	TV-tuning system	Auto Preset 99 ch	
STEREO/BILINGUAL	NICAM: B/G, I, D/K A2 stereo: B/G MTS: M		
Viewing angles		H : 178° V : 178°	
Audio amplifier/Speakers		7.5 W × 2 / 4.5 × 10 cm 2pcs	10 W × 2 / 3 × 9.5 cm 2pcs
Terminals	Antenna input	UHF/VHF 75 Ω DIN type	
	SERVICE ONLY	φ 3.5 mm jack	
	INPUT 1 (HDMI/ARC)	HDMI input	
	INPUT 2 (HDMI)	HDMI input	
	INPUT 3	VIDEO in, AUDIO in	
	AUDIO OUT	AUDIO out, Headphone (φ 3.5 mm stereo)	
	USB	USB (DC5V 1.5A output)	
OSD language		English/Simplified Chinese/Arabic/French/Portuguese/Russian/Persian/Thai/Vietnamese/Indonesia/Hebrew/Hindi	
Power requirement		AC 110 — 240 V, 50/60 Hz	
Power consumption		78 W (0.5 W Standby)	115 W (0.56 W Standby)
Dimensions	without stand	911 (W) × 567 (H) × 75 (D) mm	1125 (W) × 662 (H) × 67 (D) mm
	with stand	911 (W) × 633 (H) × 239 (D) mm	1125 (W) × 711 (H) × 231 (D) mm
Weight without stand (with stand)		7.4 kg (7.6 kg)	14.0 kg (14.5 kg)
Operating temperature		0°C — 40°C	

- As a part of policy of continuous improvement, SHARP reserves the right to make design and specification changes for product improvement without prior notice. The performance specification figures indicated are nominal values of production units. There may be some deviations from these values in individual units.
- Specification may differ depending on the selected country.

CAUTION

- Installing the Liquid Crystal Television requires special skill that should only be performed by qualified service personnel. Customers should not attempt to do the work themselves. SHARP bears no responsibility for improper mounting or mounting that results in accident or injury.
- Carefully read the instructions that come with the bracket before beginning work.

Note

SHARP[®]
SHARP CORPORATION