

# SHARP®

## FP-F40E FP-F40L



High-Density 7000\*

"Plasmacluster" and "Device of a cluster of grapes" are trademarks of Sharp Corporation.



\*The number in this technology mark indicates an approximate number of ions supplied into air of 1 cm<sup>3</sup>, which is measured around the center of a room with the "high-density plasmacluster 7000" applicable floor area (at 1.2 m height above the floor) at the medium wind volume in air purifying mode, when an air purifier using the high-density plasmacluster ion evolving device is placed close to a wall. This product is equipped with a device corresponding to this capacity.

**Free standing type**  
**Jenis berdiri sendiri**  
站立式

**AIR PURIFIER  
OPERATION MANUAL**

**PEMBERSIH UDARA  
BUKU PANDUAN OPERASI**

**空气净化器操作手册**

ENGLISH

MALAYSIA

中文

## Please read before operating your new Air Purifier

The air purifier draws in room air from the air intake, passes the air through a Pre-Filter, a Deodorizing Filter and a HEPA Filter inside of the unit, then discharges the air through the air outlet. The HEPA Filter can remove 99.97% of dust particles as small as 0.3 microns that pass through the filter and also helps absorb odours. The Deodorizing Filter gradually absorbs odours as they pass through the filter.

Some odours absorbed by the filters may break down over time, resulting in additional odour. Depending on the usage environment, especially when the product is used in extreme environments (significantly more severe than normal household use), this odour may become strong in a shorter period than expected. If the odour persists, the filters should be replaced.

### NOTE

- The air purifier is designed to remove air-suspended dust and odour, but not harmful gases (for example, carbon monoxide contained in cigarette smoke). If the source of the odour still exists, the air purifier may not completely remove the odour.

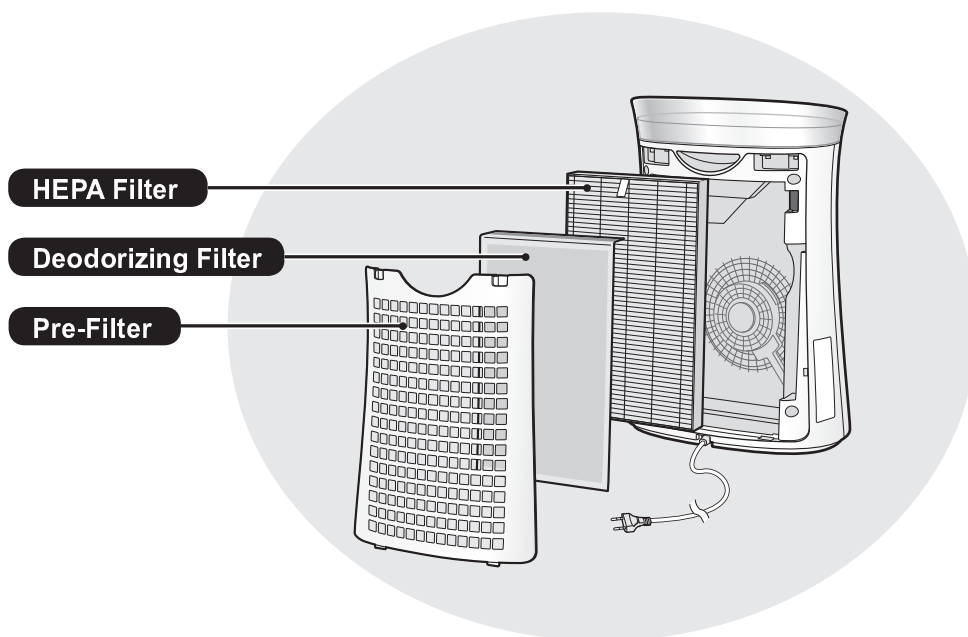

# ENGLISH

## FEATURES

**Unique Combination of Air Treatment Technologies  
Triple Filtration System + Plasmacluster**

### **TRAPS DUST\***

Pre-filter traps dust and other large airborne particles.

### **DECREASES ODOURS**

Deodorizing filter absorbs many common household odours.

### **REDUCES POLLEN & MOLD\***

HEPA filter traps 99.97% of particles as small as 0.3 microns.

### **FRESHENS**

Plasmacluster treats the air similar to the way nature cleans the environment by emitting a balance of positive and negative ions.

\*When air is drawn through the filter system.

Sensor Technology continuously monitors air quality, and automatically adjusting operation based on detected air purity.

## CONTENTS

<b>IMPORTANT SAFETY INSTRUCTIONS</b> .....	E-2
<b>PART NAMES</b> .....	E-4
<b>FILTER INSTALLATION</b> .....	E-5
<b>OPERATION</b> .....	E-6
<b>CARE AND MAINTENANCE</b> .....	E-8
<b>TROUBLESHOOTING</b> .....	E-10
<b>SPECIFICATIONS</b> .....	E-11

ENGLISH

Thank you for purchasing the SHARP Air Purifier. Please read this manual carefully. Before using this product, be sure to read the section: "Important Safety Instructions." After reading this manual, keep it in a convenient location for future reference. For your reference, we recommend to keep this manual in the place where you can read at any time.

# IMPORTANT SAFETY INSTRUCTIONS

When using electrical appliances, basic safety precautions should be followed, including the following:

**WARNING** - To reduce the risk of electrical shock, fire or injury to persons:

- Read all instructions before using the unit.
- Use only a 220-240 volt outlet.
- **Do not use the unit if the power cord or plug is damaged or the connection to the wall outlet is loosened.**
- Periodically remove dust from the power plug.
- **Do not insert fingers or foreign objects into the intake or air outlet.**
- **When removing the power plug, always hold the plug and never pull the cord.** Electrical shock and/or fire from short circuit may occur as a result.
- Be careful not to damage the power cord, it may cause electric shock, excess heat or fires.
- **Do not remove the plug when your hands are wet.**
- **Do not use this unit near gas appliances or fireplaces.**
- **Remove the power plug from the wall outlet before cleaning the unit and when not using the unit.** Electrical shock from bad insulation and/or fire from short circuit may occur as a result.
- When cleaning the unit, or when the unit is not in use, be sure to unplug the unit. Electrical shock and/or fire from a short circuit may result.
- **If the power cord is damaged, it must be replaced by the manufacturer, its service agent, Sharp Approved Service Centre or similarly qualified person in order to avoid a hazard.**
- Do not operate when using aerosol insecticides or in rooms where there is oily residue, incense, sparks from lit cigarettes, chemical fumes in the air or in very high humidity conditions, such as a bathroom.
- Be cautious when cleaning the unit. Corrosive cleansers may damage the exterior.
- Only a Sharp Authorized Service Centre should service this air purifier. Contact the nearest Service Centre for any problems, adjustments, or repairs.
- This appliance can be used by children aged from 8 years and above and persons with reduced physical, sensory or mental capabilities or lack of experience and knowledge if they have been given supervision or instruction concerning use of the appliance in a safe way and understand the hazards involved. Children shall not play with the appliance. Cleaning and user maintenance shall not be made by children without supervision.

**NOTE** - Radio or TV Interference

If this air purifier should cause interference to radio or television reception, try to correct the interference by one or more of the following measures:

- Reorient or relocate the receiving antenna.
- Increase the separation between the unit and radio/TV/wave-clock receiver.
- Connect the equipment into an outlet on a circuit different from that to which the receiver is connected.
- Consult the dealer or an experienced radio/TV technician for help.

## CAUTIONS CONCERNING OPERATION

- Do not block the intake and/or air outlet.
- Do not use the unit near or on hot objects, such as stoves or heaters or where it may come into contact with steam.
- Do not lay the unit down when using.
- **Always hold the handle on the back of the unit when moving it.**
- Do not use without the filters inside the unit.
- **Do not wash and reuse the HEPA filter and the deodorizing filter.**  
Not only does it not improve filter performance, it may cause electric shock or malfunction.

## INSTALLATION GUIDELINES

- **When using the unit, place at least 2m away from equipment utilizing electric waves such as televisions or radios to avoid electrical interference.**
- **Avoid use in locations where furniture, fabrics or other items may come in contact with and restrict the air intake and/or air outlet.**
- **Avoid use in locations where the unit is exposed to condensation or drastic temperature changes. Appropriate conditions are when room temperature is between 0 – 35 °C.**
- **Place on a stable surface with sufficient air circulation.**  
When placing the unit on a heavily carpeted area, the unit may vibrate slightly.
- **Avoid locations where grease or oily smoke is generated.**  
The unit surface may crack as a result.
- **Place the unit about 30 cm(1 ft) away from the wall in order to ensure proper airflow.**  
The dust collecting performance will be the same even if using the unit 3cm away from the wall, but place it as far as possible(30cm away recommended) because it may dirty the wall or floor around.

## FILTER GUIDELINES

- Follow the instructions in this manual for correct care and maintenance of the filter.

# PART NAMES

## FRONT

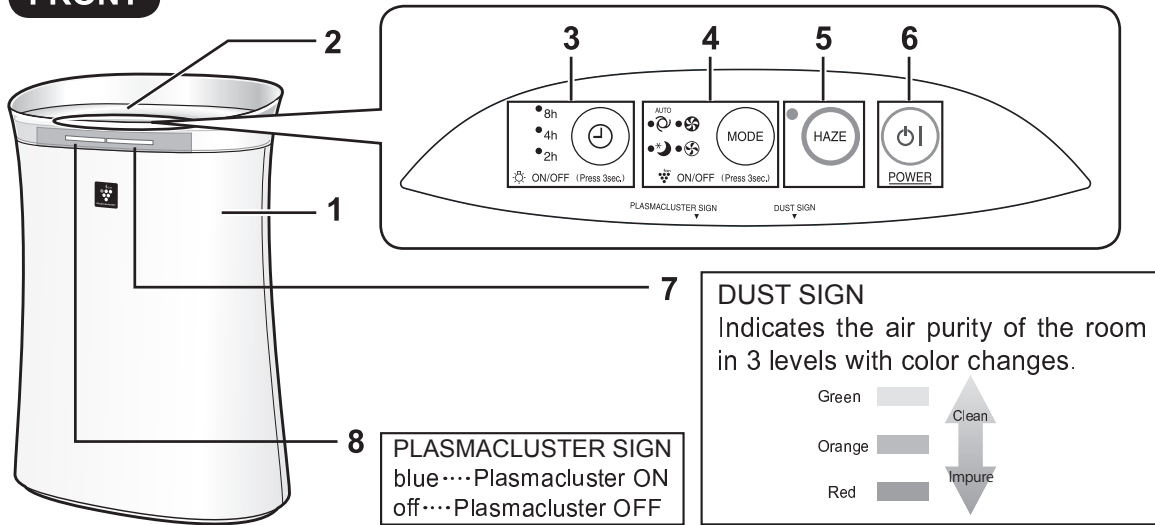

## BACK

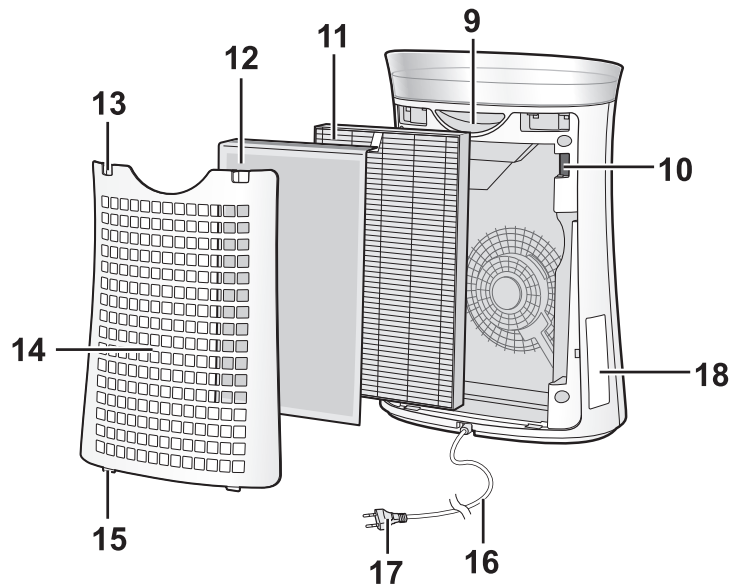

1	Main Unit	10	Dust sensor
2	Air Outlet	11	HEPA Filter
3	OFF TIMER Button / LIGHT ON/OFF Button (Press 3 sec.)	12	Deodorizing Filter
4	MODE Button / MODE Indicator Light (green) Plasmacluster Ion ON/OFF Button (Press 3 sec.)	13	Upper Tabs
5	HAZE Button / HAZE indicator Light (green)	14	Back Panel (Pre-Filter)
6	POWER ON/OFF Button	15	Bottom Tabs
7	DUST SIGN	16	Power Cord
8	PLASMACLUSTER SIGN	17	Plug (Shape of plug depends on country.)
9	Handle	18	Date Label

# FILTER INSTALLATION

Be sure to remove the power plug from the wall outlet.

To maintain the quality of the filter, it is installed in the main unit and packed in plastic bag. Be sure to remove the filter from the plastic bag before using the unit.

ENGLISH

## 1 Remove the Back Panel.

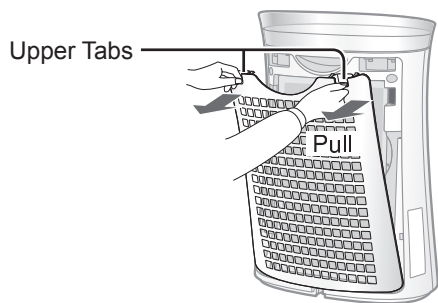

## 2 Remove the plastic bag from the Filter.

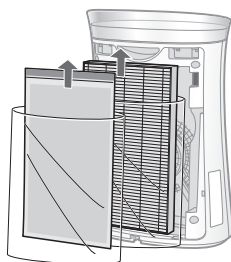

## 3 Place the Filter within the main unit.

Do not install the filter backwards or the unit will not operate properly.

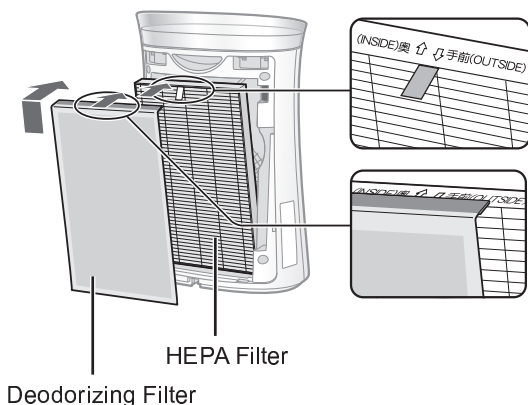

## 4 Replace the Back Panel to the main unit.

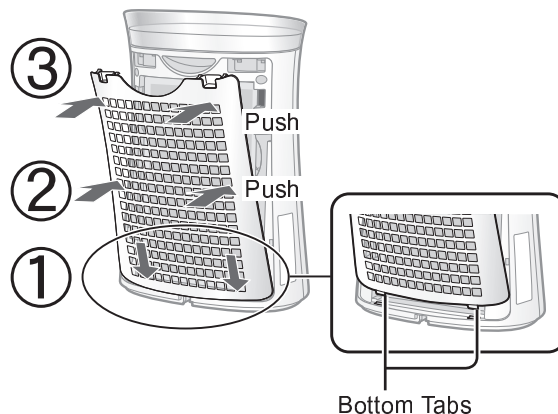

## 5 Fill in the usage start date on the Date Label.

Use the date as a guide for the filter replacement schedule.

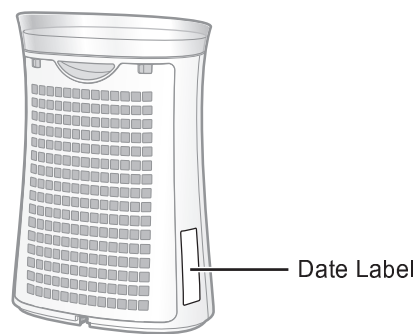

Starting date of use	
.	.
.	.
.	.

• Do not operate the unit without the filter.

# OPERATION

## CLEAN AIR

**START**



POWER



**STOP**



POWER

- Select the desired fan speed.
- Unless the power cord has been unplugged, the operation starts in the previous mode it was operated in.

## HAZE

The unit operates at HIGH fan speed for 60 minutes and then alternates between Low and High level for 20 minutes each.

**START**

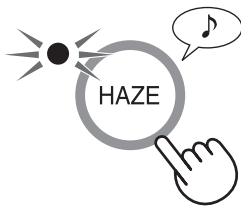

10 minutes: Max High fan level
50 minutes: High fan level
20 minutes: Low fan level
20 minutes: High fan level

### NOTE

- If Plasmacluster Ion is OFF, Plasmacluster Ion will not be released.
- It is possible to switch this mode to another while operating. However, the HAZE mode will not function after switching mode.

## FAN SPEED

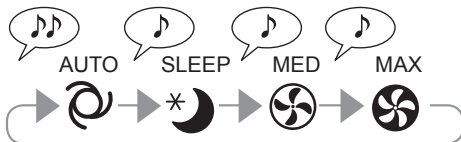
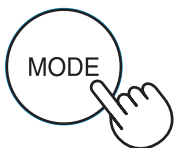

### NOTE

#### AUTO

- The fan speed is automatically switched depending on the amount of impurities in the air. The sensors detect impurities for efficient air purification.

#### SLEEP

- The unit will operate very quietly, and the fan speed is automatically switched depending on the amount of impurities in the air.

DUST/PLASMACLUSTER SIGN go off automatically.

Even though the indicator is off, Plasmacluster Ion is dispersed into air unless Plasmacluster Ion is turned off by



ON/OFF (Press 5sec)





## OFF TIMER

Select the length of time you want, with the unit on. The unit automatically stops once the selected time is reached.

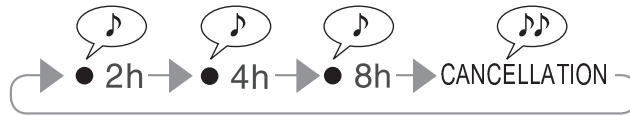
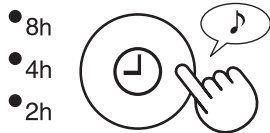

## Light Control

You can set the DUST/PLASMACLUSTER SIGN to OFF when their SIGN is bright.

**ON**



ON/OFF (Press 3sec.)

**OFF**

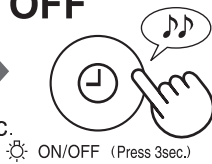

ON/OFF (Press 3sec.)

more than 3 sec.

more than 3 sec.

### NOTE

- When the unit starts operation, the DUST/PLASMACLUSTER SIGN always lights.
- In SLEEP mode, Light Control button doesn't operate.

## Plasmacluster Ion ON/OFF

When Plasmacluster Ion is ON, the PLASMACLUSTER SIGN will turn on. (blue)  
(In operation)

**ON**

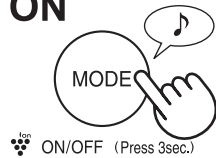

ON/OFF (Press 3sec.)

more than 3 sec.

**OFF**

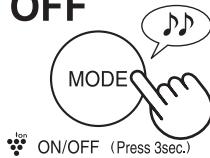

ON/OFF (Press 3sec.)

more than 3 sec.

## ADJUSTMENT OF SENSOR DETECTION SENSITIVITY

Set to "Low" if the DUST SIGN is constantly red to reduce sensitivity, and set to "High" if the DUST SIGN is constantly green to increase sensitivity.

**1**

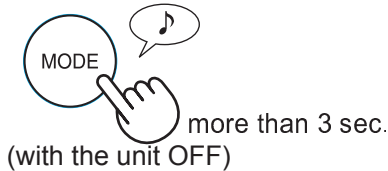

**2**

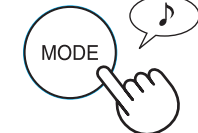

**3**

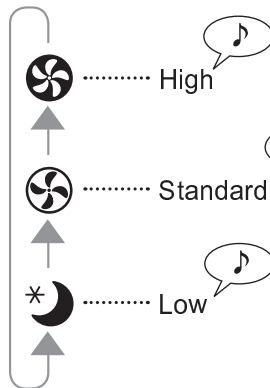
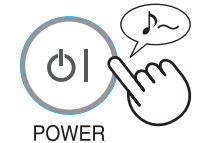

### NOTE

- If the power OFF Button is not pushed within 8 seconds of adjusting sensor sensitivity, the setting will be saved automatically.
- The sensor sensitivity setting will be saved even if the unit is unplugged.



# CARE AND MAINTENANCE



To maintain optimum performance of this air purifier, please clean the unit including the filter periodically.

Be sure to disconnect the power cord from the wall outlet before performing any maintenance.

## BACK PANEL (Pre-filter)

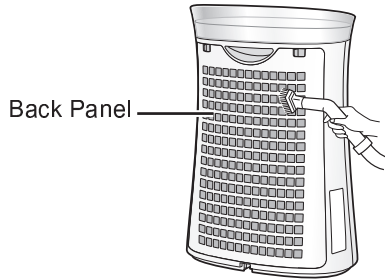

Gently remove dust from the back panel, using a vacuum cleaner attachment or similar tool.

### CAUTION

Do not apply excessive pressure, when scrubbing the back panel.

### NOTE How to clean hard to remove dirt

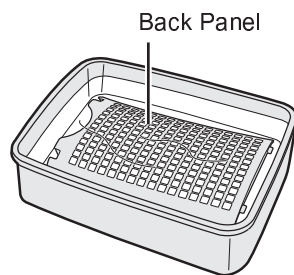

1. Add a small amount of kitchen detergent to water and soak for about 10 minutes.
2. Rinse off the kitchen detergent with clean water.
3. Completely dry the filter in a well-ventilated area.

## UNIT



### Wipe with a dry, soft cloth

For stubborn stains or dirt, use a soft cloth dampened with warm water.

### CAUTION

#### •Do not use volatile fluids

Benzene, paint thinner, polishing powder, etc., may damage the surface.

#### •Do not use detergents

Detergent ingredients may damage the unit.

## SENSOR

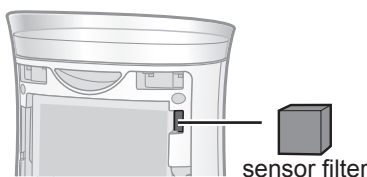

1. Remove the Back Panel.
2. Remove the Sensor filter.
3. If it is very dirty, wash it with water and dry it thoroughly.

Be sure to remove the power plug from the wall outlet.

## FILTER REPLACEMENT GUIDELINES

**Replacement timing** About 2 years after operating

### Do not wash and reuse the filter

The filter life and replacement period are based on the condition of smoking 5 cigarettes per day and the dust collection power is reduced by half compared with that of new filter. Filter life varies depending on the room environment, usage, and location of the unit. We recommend to replace the filter more frequently if the product is used in a condition significantly severer than normal household use.

## REPLACING THE FILTER

### Replacement Filter

Model:FZ-F40SFE

- HEPA Filter : 1 unit
- Deodorizing Filter : 1 unit



See page E-5 for directions on how to install the filter when replacing.

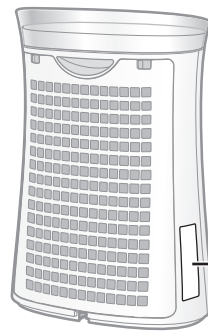

Date Label

- Please consult your dealer for purchase of replacement filter.
- Use only filter designed for this product.

### Disposal of Filter

Please dispose of the replaced filter according to the local disposal laws and regulations.

HEPA Filter materials :

- Filter : Polypropylene
- Frame : Polyester

Deodorizing Filter materials :



- Polypropylene, Polyester, Activated charcoal

# TROUBLESHOOTING

Before calling for service, please review the Troubleshooting chart below, since the problem may not be a unit malfunction.

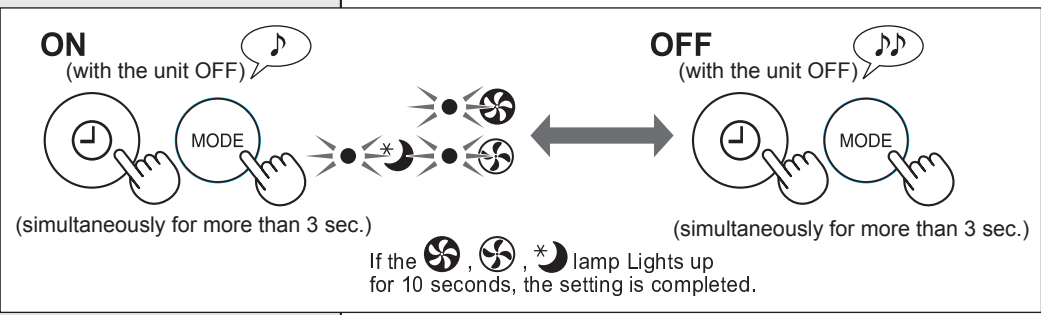
SYMPTOM	REMEDY (not a malfunction)
Odours and smoke are not removed.	<ul style="list-style-type: none"> <li>Replace the filters if they appear to be heavily soiled. (Ref. E-9)</li> </ul>
The DUST SIGN illuminates green even when the air is impure.	<ul style="list-style-type: none"> <li>The air could be impure at the time the unit was plugged in. Unplug the unit, wait one minute, and plug the unit in again.</li> </ul>
The DUST SIGN illuminates orange or red even when the air is clean.	<ul style="list-style-type: none"> <li>Sensor operation is affected if the dust sensor openings are dirty or clogged. Gently clean the dust sensor openings. (Ref. E-8).</li> </ul>
A clicking or ticking sound is heard from the unit.	<ul style="list-style-type: none"> <li>Clicking or ticking sounds may be audible when the unit is generating ions.</li> </ul>
The discharged air has an odour.	<ul style="list-style-type: none"> <li>Check to see if the filters are heavily soiled.</li> <li>Clean or replace the filters.</li> <li>Plasmacluster Air Purifiers emit small traces of ozone which may produce an odour.</li> </ul>
The unit does not operate properly when cigarette smoke is in the air.	<ul style="list-style-type: none"> <li>Is the unit installed in a location that is difficult for the sensor to detect cigarette smoke?</li> <li>Is the dust sensor opening blocked or clogged? (In this case, clean the opening.) (Ref. E-8)</li> </ul>
The DUST SIGN is turned off.	<ul style="list-style-type: none"> <li>Check to see if the Lights OFF Mode selected. Press  for 3 seconds to light On. (Ref. E-7)</li> <li>Check to see if the SLEEP mode is selected. The DUST/PLASMACLUSTER SIGN are turned off automatically after the SLEEP mode is selected.</li> </ul>
The DUST SIGN lights change colour frequently.	<ul style="list-style-type: none"> <li>The DUST SIGN lights automatically change colours as impurities are detected by the dust sensor.</li> </ul>
<b>AUTO RESTART</b> After a power failure, automatically resume the operation when the power recovers.	Auto Restart can be set. <ul style="list-style-type: none"> <li>Even when the plug is unplugged or the breaker is thrown during the operation, the operation resumes at the previous operation mode and settings if the power recovers.</li> </ul>



If the , ,  lamp Lights up for 10 seconds, the setting is completed.

# SPECIFICATIONS

Power supply		220-240V 50-60Hz		
Fan Speed Operation	Fan Speed Adjustment	MAX	MED	SLEEP*1
	Rated Power	31W	12W	3.5~5.7W
	Fan Speed	240m <sup>3</sup> /hour	150m <sup>3</sup> /hour	48~90m <sup>3</sup> /hour
Recommended Room Size		~30m <sup>2</sup> *2		
High density Plasmacluster ion recommended room size		~23m <sup>2</sup> *3		
Cord Length		2.0m		
Dimensions		383mm(W)x209mm(D)x540mm(H)		
Weight		4.7kg		

ENGLISH

- \*1 The fan speed is automatically switched depending on the amount of impurities in the air.
- \*2 Size of a room which is appropriate for operating the unit at maximum fan speed.
  - It indicates the space where a certain amount of dust particles can be removed in 30 minutes (JEM1467).
- \*3 Size of a room in which approximately 7000 ions can be measured per cubic centimeter in the center of the room (at a height of approximately 1.2 meters from the floor) when the product is placed next to a wall and run at the MED operation position.

## Standby Power

In order to operate the electrical circuits while the power plug is inserted in the wall outlet, this product consumes about 1.0W of standby power.  
For energy saving, unplug the power cord when the unit is not in use.