

# SHARP

ES-G80G  
WASHING MACHINE

---

## Operation Manual

# SHARP

SHARP CORPORATION  
OSAKA, JAPAN

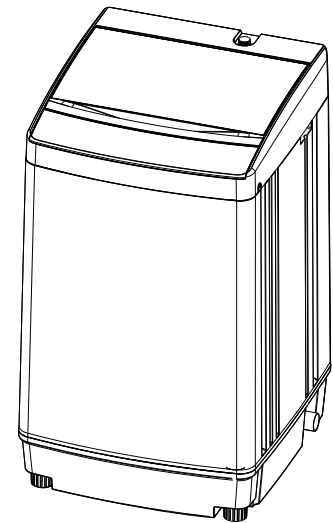

If the appliance is sold or transferred to another owner or if you moved house and leaving the appliance, always ensure the manual is supplied with the appliance in order for the new owner can get to know its functions and its relevant warnings. These warnings have been provided for your safety. You **MUST** read them carefully before installing or using the appliance.

# Contents

## Before using

Parts name.....	1
Cautions.....	2
Installation and adjustment.....	4
How to use drain pipe.....	5
Water inlet installation.....	6

## Operation

Preparation before operation.....	8
Load laundries.....	9
Use of detergent.....	9
Control panel instructions.....	10
Operation steps.....	12
Additional functions.....	15

## Others

Maintenance.....	16
Common non-fault phenomenon.....	17
Specification.....	20

# Specification

Model	ES-G80G
Rated capacity of wash and spin ( Dry laundries weight )	8.0kg
Rated voltage and frequency	220-240V~ · 50Hz
Water level / Water volume	10/66L 9/61L 8/56L 7/52L 6/48L 5/44L 4/40L 3/36L 2/32L 1/28L
Inlet pressure	0.03MPa~0.85MPa
Rated input power	Wash:480W Spin :310W
Weight	About 34kg
Dimensions	W560mm D585mm H944mm

# Parts name

Before using

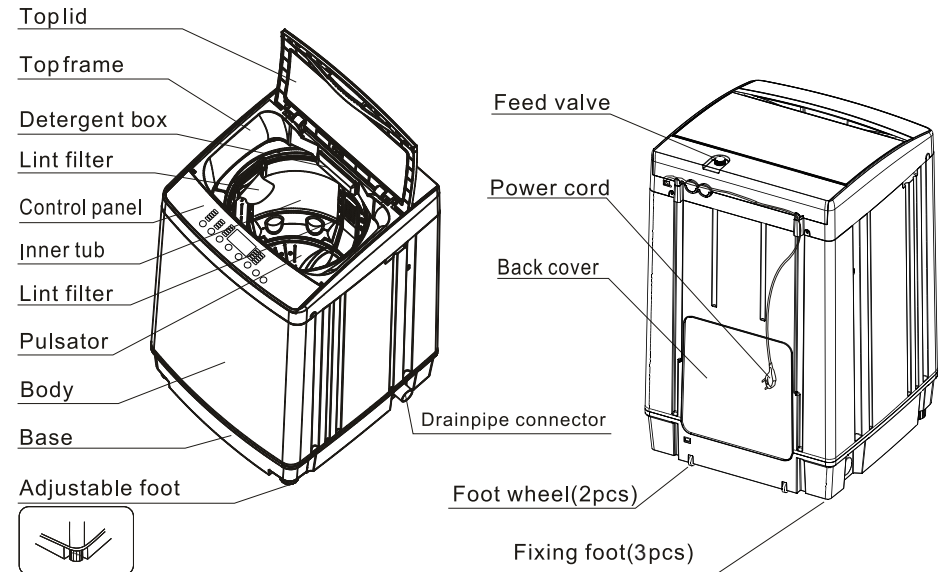

## Accessories

Bottom cover (1pc)	Water inlet hose (1pc) Water inlet hose connector(1pc)	Drainpipe(1pc) Drainpipe clip(1pc)

## Symbol definition

Warning symbols 	Pay attention to the warning symbols. There may be serious risks on personal safety or may damage the washing machine if not followed.
Prohibited symbol 	The contents of this symbol are prohibited. It may damage the appliance and can lead to injury.

### WARNING

Please insert the plug into the power socket with rated voltage 220-240V.

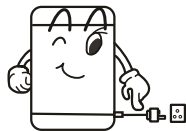

Always unplug the appliance and turn off the water when the power is cut, moving or cleaning the washing machine, or if it is not in use. Do not insert or pull off the plug with wet hand.

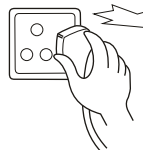

Do not make the power cord bended, stretched, twisted, strapped or changed, pressed or nipped. If the power cord or plug is damaged or the socket becomes loose, it must be repaired or replaced by our appointed service center after sale to avoid danger. The pin of the plug must remain clean. Please clean it carefully with dry cloth.



Don't install the washing machine in bathroom or damp places. Do not wash the machine with water, do not put wet clothes on the control panel film.

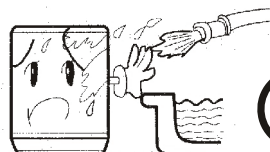

Do not use water hotter than 50° C.



If the machine is situated on a carpeted floor, please adjust the feet in order to allow air to circulate freely.

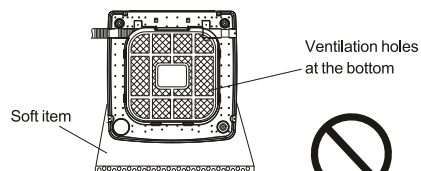

Do not wash raincoat, bike cover, feather dress and waterproof laundries, which will make the washing machine to have abnormal vibrations during spinning.



Do not share the same socket with other electric appliances. Do not use the damaged plug or loose socket.

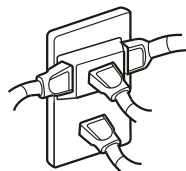

### Settlement

Insert the plug tightly  
Check the socket or change to another socket  
Press power switch  
Check power supply

Install the inlet hose again  
Tighten the connector of the machine

Put down the drainpipe  
Straighten or clean the drainpipe

Restart when water supply is resumed  
Open the tap  
Clean the filter. Refer to the "clean inlet gate" procedure.

The machine is adjusting automatically

Close the top lid  
Close the top lid

Normal

Normal

Notes : If there is still a fault after the above checks, please pull out the plug and contact the seller right away. It is dangerous to repair this product by yourself.



# Common non-fault phenomenon

Before contacting the technicians, please make the following checks:

Phenomena	Possible reason
Control panel has no display	Plug is not inserted tightly No electricity in the socket Power switch is not turned on Power supply is cut off
Inlet hose leaks	Inlet hose connector (connecting with the tap) is not fixed tightly Inlet hose and washing machine connector is loose
It does not drain	Drainpipe is not put down Drainpipe is bended or gets blocked
It does not water fill	No water supply Tap is not open Inlet hose gets blocked
Spin stops and water refills during spin program	Laundries is too much or too little or the machine is not place stably
Press the program button to select SPIN, but It does not spin	Top lid was not closed when drain is finished Open up the top lid when start drain
The spin is intermittent when spin starts	Balance the laundries to reach the best spin action
First time to use, some water flows from the drainpipe	The remaining water when the factory make test

# Cautions

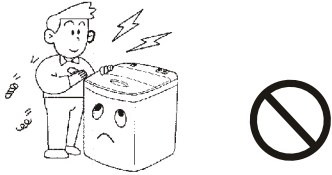
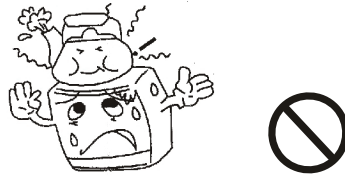
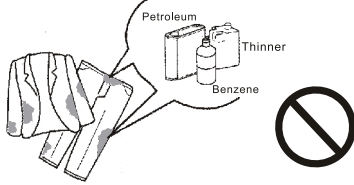
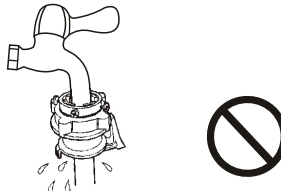
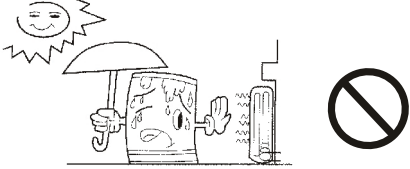
Before using

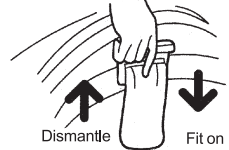
<p>Do not put hands into the working machine. It is dangerous even if the speed is very slow. Take special care of the children, and forbid them to climb on the washing machine.</p> 	<p>It is dangerous to alter the specifications or attempt to modify this product in any way.</p> 
<p>Do not overload the appliance or put any hot goods (such as the kettle with hot water) on the washing machine.</p> 	<p>Garments which have been in contact with volatile petroleum products should not be machine washed.</p> 
<p>Before washing, please ensure the tap is open and the inlet hose is installed properly.</p> 	<p>Keep the appliance away from direct sunlight and heat sources like the heater.</p> 
<p>This appliance is not intended for use by persons (including children) with reduced physical, sensory or mental capabilities, or lack of experience and knowledge, unless they have been given supervision or instruction concerning use of the appliance by a person responsible for their safety. Children should be supervised to ensure that they do not play with the appliance.</p> 	<p>To prevent the lint from blocking cascade outlet during washing, please keep the lint filter in good condition, install it to proper position and clean it in time.</p> 

## Notice

- Any objects such as coins, safety pins, nails, screws, stones or any other hard, sharp material can cause extensive damage and must not be placed into to the machine.
- It is suggested to use low foam washing powder.

# Installation and adjustment Before using

Please install and adjust the machine according to the requirements of the manual. Correct operation is very important for your safety.

## Unpacking

- Unpack the carton and take out the bottom cover.
- Open the top lid of washing machine and take out all of the accessories.
- Remove all wrappers, including the polystyrene base.  
You are advised to keep all the packaging for reuse in case the machine is to be transported again.

## Installing the bottom cover

- Let the back of washing machine incline forward, make the side of the bottom cover with sticker description facing outside. Insert it to the bottom of washing machine along the direction of the arrow.
- Remove two fixing clamp by scissors, insert it on the cover's aloted holes as shown on the figure (gently pull fixing clamp and it should not be pulled out). Make the bottom cover fixed on the base.

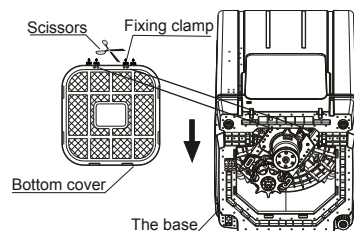

## Positioning

The distance between the washing machine and the wall should be more than 50mm, and the maximum allowable angle of the shank base of the machine is 1°. The slanting or rough ground may cause operating stopped or unstable, please adjust it with the following methods:

- Make it horizontal.  
Use a tied thread with plumb to check if it is horizontal.

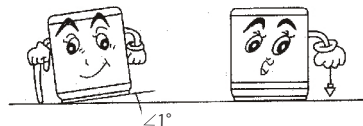

- Adjust the adjustable foot
  - 1) Lift up the adjustable foot gently, loose the adjustable nut and twist the adjustable foot.
  - 2) Fasten the nut after adjustment.

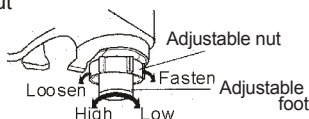

# Common non-fault phenomenon Others

## 1. Abnormal display

Display	Explanation	Settlement
E0	The top lid is opened when preset is started	Close the top lid and clear up the alarm
E1	After 15 minutes of draining time and still not reaching the water level setting	Open the top lid and refer to the "before using" procedures and "common non fault phenomenon" on this manual to settle it, then close the top lid and clear up the alarm.
E2	The top lid is open when spinning	Close the top lid and clear up the alarm
E3	Spin does not balance	Open the top lid, make the laundries place equally, then close it and clear up the alarm
E4	After 20 minutes of water filling time and still not reaching the water level setting	Open the top lid and refer to the "before using" procedures and "common non fault phenomenon" on this manual to settle it, then close the top lid and clear up the alarm.
E5 child-lock light flashing synchronously	The top lid is opened after setting child-lock	Close the top lid and clear up the alarm
F1	Water level sensor is wrong	Turn the power off and leave it for 1minute. After that,turn the power on again. If the same error is displayed,cut the power supply and call a technicians.

## 2. Imbalance adjustment

During spinning, if the laundries are not placed equally in the tub, it would cause violent vibration. This machine has imbalance adjustment function, and the vibration testing system will supervise the running. Once vibration is beyond certain level, the adjustment system will start automatically to adjust the imbalance.

## 3. Power supply is cut off automatically

- 1) Press the power supply button and did not start the program in 10 minutes, the power supply will be cut off automatically.
- 2) After the washing is finished, buzzer will activate. The power supply will be cut off automatically.

## 4. Child lock function

- 1) If set child lock function, all the buttons will be locked including POWER. If the top lid is opened during the washing machine working, the washing will be stopped and give an alarm. But if you can close the top lid in 5 seconds, the washing machine will stop alarm and continue working. If can not close the top lid in 5 seconds, the washing machine will begin draining if there is water in the inner tub is 5 cm higher, alarm will be given every 10 minutes (alarm is always given). When the draining is finished, the washing machine will be in the stare of washing, if close the top lid, the washing machine is unlocked and start working as previous setting.
- 2) Once child lock is set, if open top lid over 5 seconds during washing or rinse ( there is water in the inner tub), washing machine will drain and give an alarm. If you unlock the function during draining, the washing machine will add water to setting water level and continue working.

### Maintenance methods

#### After the end of the programme

- The machine stops automatically, and music buzzer will remind you to take out the laundries or start again.
- Once you have finished using the machine, you are advised to unplug it and turn off the water taps to avoid unexpected leak or fire.

#### External cleaning

Clean the exterior cabinet of the appliance with soft cloth. Do not use cleanser, volatile chemical materials to clean the machine, which will damage plastic parts and the surface.



#### Clean inlet gate

It is possible that the inlet filter net can be blocked by the dust, please clean it according to the follow steps:

1. Close the tap and turn on the power switch.
2. Start the washing machine for 5 seconds (make the water in the inlet hose flows to the tub), and cut off the power supply.
3. Pull off the inlet hose, remove and clean the inlet valve and the inlet net, and install again.

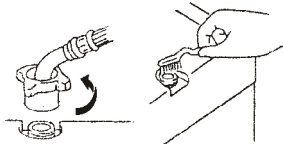

#### Clean the lint filter

- It is necessary to use lint filter during washing.
- After washing, please clean the lint filter in time.

Clean the lint filter according to the following steps:

1. Pull out the lint filter.
2. Turn the filter net inside out and wash it.
3. Reverse back the filter net and remount it.



Groove

#### Magic filter cleaning

1. pull out magic filter
2. open the box and clean it
3. close it and reinstall it
4. check if the lint block part is in good condition

press this part and pull out to take out the magic filter

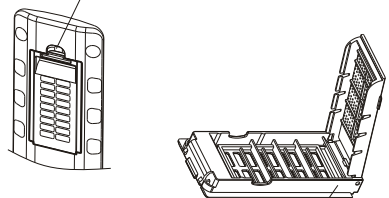

lint block part (black rubber)

1. Once you have finished using the machine, you are advised to turn off the water taps. (If necessary pull out the inlet hose)
2. Do not keep water in tub for a long time. When washing is finished, drain it right away.
3. Once you have finished using the machine, you are advised to unplug it
4. Put the electric cable and the drain hose in order.
5. Wipe the water on the surface and in tub with soft cloth and keep the top lid opening for a while. It helps to prevent mould and stagnant smells forming inside the appliance,

If the water in the inner tub has possibility to freeze, please do like below:

1. In winter, if remaining water freeze can cause the washing machine trouble, please take off the water inlet hose and drain out the water in the hose and inner tub.
2. If the water freeze, please don't operate the washing machine. Put 40° hot water in the tub, the hot water should submerge the pulsator, after a few minutes, rotate the pulsator by hand gently, then you can operate the washing machine.

### Install drainpipe

Set the drainpipe clip into the drainpipe to 2-3cm (from the drainpipe end without hook). Then install the drainpipe into the drainpipe connector and fixed it with the drainpipe clip. After that put up the drainpipe clip to fasten the grip.

### How to change the direction of the drainpipe

1. Take off the drainpipe and drainpipe clip from the drainpipe connector. Put soft mat on the floor and gently put down the washing machine front side on the mat. Unscrew the back cover by screwdriver and gently unmount the back cover. Unscrew the drainpipe connector (on the right of the washing machine), then loosen the drainpipe connector.

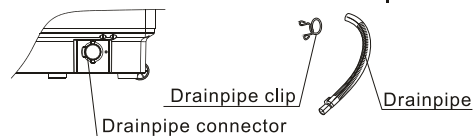

(Washing machine's right side view)

3. With proper force, take off the drainpipe gate stopper on the left side of the washing machine. The drainpipe gate stopper is fixed on washing machine base with two clips, look for the fixing orientation at the back opening.

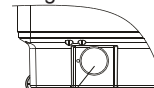

(Washing machine's left side view)

2. Extrude the drainpipe with proper force and take out drainpipe hoop (on right of the washing machine). Make the inner drainpipe loosen.

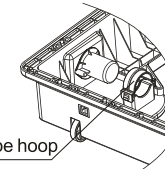

(Washing machine's inside view)

4. Pull the inner drainpipe to another side, avoid distortion of the inner drainpipe. As per foregoing description, fix the inner drainpipe with the drainpipe hoop. Fix the the drainpipe connector with the screw and install the the drainpipe gate stopper on the other side of the washing machine. Gently stand the washing machine, fix the back cover with screw and install the drainpipe and drainpipe clip into the drainpipe connector.

### Water drainage

The drainpipe should drain smoothly

1. The height of the drainpipe should be less than 10cm, otherwise the drainage will not be smooth and need a long time to drain, the machine may stop during working.
2. Do not step on or press the drainpipe.

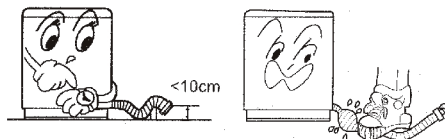

3. Cut the drainpipe if it is too long. Cut the front end of the drainpipe slantingly to make drainage smoothly.



4. Purchase a proper hose if you need additional drainpipe. Its diameter should not be less than 30mm and length should not exceed 1.5m.

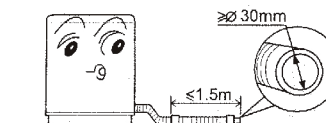

If the additional drainpipe is too long, cut some at A or B point.

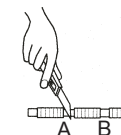

### Tap selection

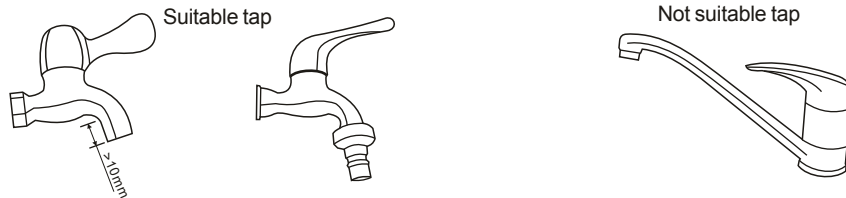

The front end should be longer than 10mm. The tap exit end face should be flat and smooth, if not file it to avoid leakage.

### Connect the inlet hose connector to the tap

1. Press down the slider and remove the inlet hose connector from the inlet hose, like below illustration 1.
2. Loosen the four bolts on the inlet hose connector till the tap can be accessed, then set the inlet hose connector in the tap, see illustration 2. (if the tap caliber is too large and could not set the inlet hose end, unscrew the four bolts and take out the bushing, tap exit end must be flat, otherwise it will leak, see illustration 3)

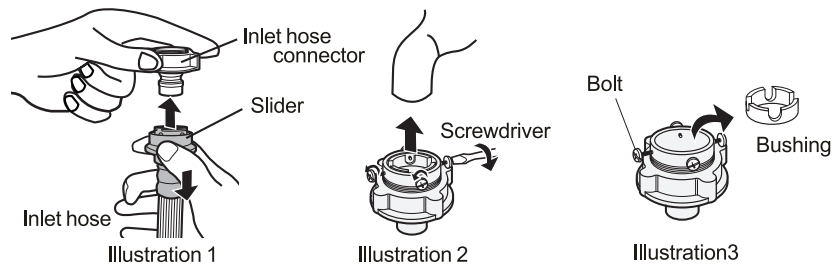

3. Fasten the four bolts in the inlet hose connector evenly, see illustration 4.
4. Twist the fastening as seen on the illustration.

Remark: before twisting the nut, the threading is about 4mm above the upper surface of the nut, after twisting, the threading is less than 2mm above the upper surface of the nut, see illustration 6.

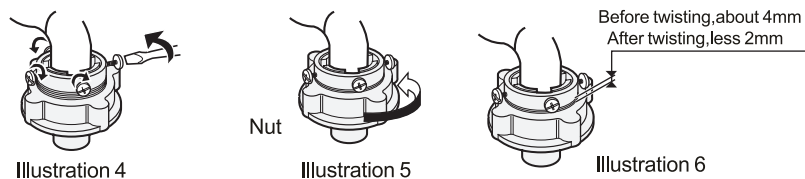

### Soak function

Press and hold for 2 seconds



When you choose "Normal", "Speedy", "Air Dry", "Blanket", "Soft", "Baby" or "Delicate" program, you can use soak function before wash.

After selecting the program, press "WASH" key for 2 seconds to set soak function.

- When you set this function, the wash procedure can not be cancelled.

### Child lock

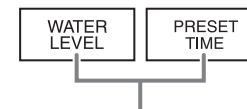

Press and hold at the same time for 3 seconds

#### ①. Before start

You can set child lock by pressing and holding "WATER LEVEL" key and "PRESET TIME" key at the same time for 3 seconds.

"CHILD LOCK" is displayed on the operation panel. Press "START/PAUSE" and the machine is locked. Press and hold these keys for 3 seconds again to unlock this function.

#### ②. After start

You can set this function with the same way as ①, the machine is locked directly with the same way as ① to unlock this function.

### Add water



During wash (including rinse), press "WATER LEVEL" key to add water as necessary. Un-press will stop adding.

Or pause the washing machine by pressing "START/PAUSE" key, and press "WATER LEVEL" key to select water level, then press "START/PAUSE" key again.

**When you reset higher water level than present:**

The washing machine will add water to the setting level automatically and continue working.

**When you reset lower water level than present:**

The new water level will be valid in next water inlet.



### Tub clean

#### Caution

- Do not put the clothing in the tub for this course.

1



Put the washing machine cleaner in the washing tub.

2



Close the top lid and press "POWER ON/OFF" key.

3



Press "PROGRAM" key to select the "Tub" program.  
"Soak" is displayed when the "Tub" program is selected.



Press "WASH" key, and select the washing time.  
(2h → 4h → 6h → 9h)



Press "WATER LEVEL" key, and select the water level as necessary.

4



Press "START/PAUSE" key.  
The washing machine starts to supply water, and displays the remaining operation time.

### Connect the inlet hose to the washing machine

- Do not take off the water absorption cushion. Please check if the cushion is missing or damaged before each usage. If it is, contact the seller immediately.
- Put the inlet hose nut on the inlet valve connector.
- Fasten the inlet hose nut and swing it gently to make sure it is suitable.

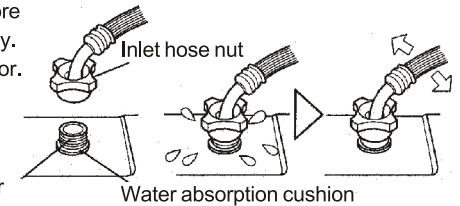

**Cautions:** When install the washing machine, please use the new hose assembly along with the washing machine, old hose assembly can not reuse.

### Connect the inlet hose connector to the inlet hose

- Put the slider down and insert the inlet hose into the inlet hose connector.
- Insert the hose firmly and the click sound is heard.

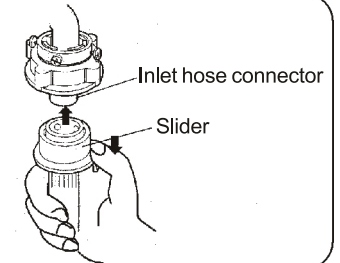

### Check the connection between inlet hose connector and the tap

- Swing the inlet hose gently to confirm if it is fastened.
- After installation, open the tap and check if it leaks.
- Do not bend the inlet hose with overstrain.
- Before each usage, check the connection between inlet hose connector and the tap, and the installation of inlet hose. Make sure they are firmly fitted to prevent dropping from improper installation position.

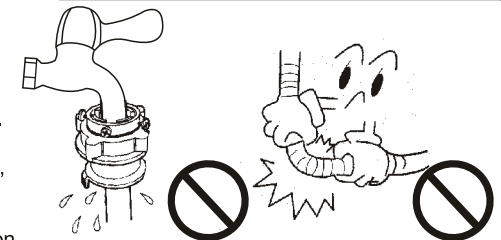

### Dismantle the inlet hose

- Close the tap.
- If you use the washing machine more than once a week, there is no need to remove the inlet hose connector to avoid damaging the fixing screw.

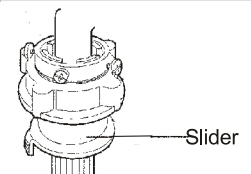

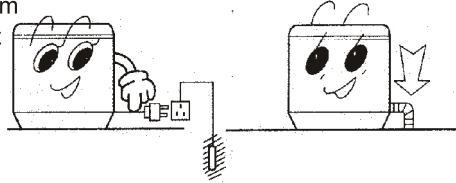

### Preparation before washing

1. Connect the inlet hose and open the tap.
2. This appliance must be earthed. Confirm the socket is earthed reliably and insert the power plug. The earth terminal should not link to gas pipeline, tap pipeline etc.
3. Put down the drainpipe.

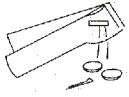

Warning: the temperature of the water should be less than 50 °C !

Before washing the laundries, please pay attention to the followings:

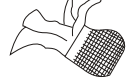
<p>Make sure if there is special requirements for the laundries.</p>	<p>Before washing, empty all pockets of small objects which may have been left inside (coins, keys, screws etc.).</p>	<p>Knot the long band, fasten the buttons and close the zippers.</p>	<p>Do not overload the machine. Load the laundry loosely alternating large items with small ones.</p>	<p>Sort the laundry according to the type of fabric, color-fastness and how dirty it is. Put thin laundries, woolens and such prone to wear and tear laundries into washing bag.</p>
				

- A. Make sure the laundries are washable.
- B. It is essential to wash new colored items separately when washing for the first time. White items should not be washed with colored items.
- C. Please immerse the non-absorbable laundries by hand.
- D. Some stains such as fruit, wine, grass, rust, etc. are difficult to remove and should be treated before washing with specific products, which can be found in most household shops. In some cases it may help to soak the stain before washing with a special pre-soak product or biological detergent.
- E. Overturn the nap fabric and long floss laundries before putting them into the machine.
- F. Do not put the laundries polluted by chemicals into the machine directly.
- G. Very small item (handkerchiefs, ribbons, socks etc) should be washed in a washing bag or a pillow case.

### Spin only

1



Put the clothes in the tub, and press "POWER ON/OFF" key.

2



Press "SPIN" key.

- Press the key again to set the spinning time as necessary.

3



- Close the top lid properly.

Press "START/PAUSE" key.

When the washing is finished, the buzzer will alarm and the power supply will cut off automatically.

### Basic operation

1



Put the clothes in the tub, and press "POWER ON/OFF" key.

2



Press "PROGRAM" key to select the program as necessary.

- When turning on the machine, the program is "Normal".

3

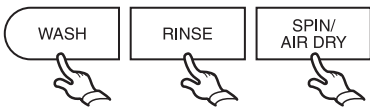

Change "WASH" / "RINSE" / "SPIN" settings as necessary.

4



Select the appropriate water level according to your laundries quantity as necessary.

5



Press "START/PAUSE" key.

- Put in detergent as required, and close the top lid properly.

When the washing is finished, the buzzer will alarm and the power supply will cut off automatically.



- The capacity of washing and spinning of the machine refer to the largest weight of the standard laundries under dry condition. Washing quantity shall be lower than the rated capacity. The maximum capacity of this machine is 8.0kg.
- Different thickness, size and type of the laundries will influence the actual washing capacity. It is suitable that the laundries can be turned round normally during washing.
- Do not select high water level when laundries are less than 1.5kg to avoid water splashing.

### Use of detergent

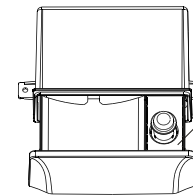

Softener box

Put the needed washing powder in the detergent box and softener in the softener box evenly

#### How to use bleach

- Fill water to the selected level, dilute the bleach in the container, and pour it slowly into the washing tub.
- Do not use bleach for colored or figured laundries as they are prone to lose colors.
- Do not put bleach to laundries directly.
- Refer to the manual for the usage and quantity of the bleach.
- Please dissolve powder bleach before use.

- Remarks: avoid splashing of water and waste of washing powder, water level should not be too high if laundries are too small.

#### How to use softener

- The machine automatically adds the softener to the inner tub during the last "rinse" process.

#### How to use the washing powder

- Dissolve in the machine directly (not suitable for preset program)
  1. Low water level.
  2. Add the washing powder, and run for 30 seconds to dissolve it completely.
  3. Put laundries in, select suitable water level.
- The instant dissolving of the washing powder
  1. Prepare warm water of 30°C in a container.
  2. Pour the powder while stirring to fully dissolve it.
- The washing powder is more prone to pollute the laundries than the detergent, therefore, please use it with proper quantity.
- Washing powder with poor quality or not used for a long period may get blocked, please clean the detergent box in time.

### Control panel / Display

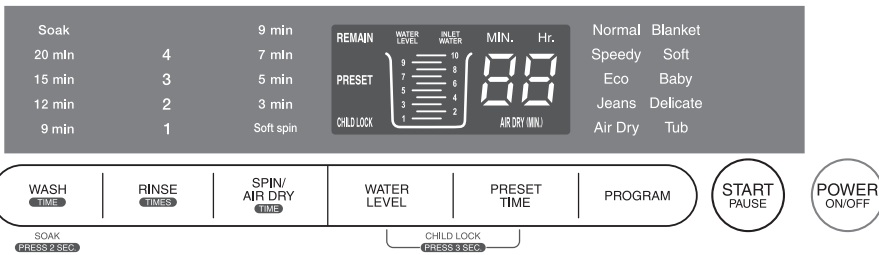

	Plug the machine in and then press this key, the machine will turn on. Press this key again, it will turn off.																				
	Press this key after turning on, the selected program will start. Press this key again, the operation will pause. Press it once again, the operation will resume.																				
	<p>Press to select the program. You can select the program from below according to the kind of your laundries.</p> <table border="1"> <tr> <td>Normal</td> <td>Wash normally soiled everyday clothing.</td> </tr> <tr> <td>Speedy</td> <td>Wash speedy for not-so-dirty clothing.</td> </tr> <tr> <td>Eco</td> <td>Wash daily clothing with saving electricity and water.</td> </tr> <tr> <td>Jeans</td> <td>Wash sturdy and heavy soiled clothing.</td> </tr> <tr> <td>Air Dry</td> <td>Program for reducing the time to dry. After spinning, blow air to clothing in the tub to reduce the time to dry in the shade greatly.</td> </tr> <tr> <td>Blanket</td> <td>Wash strongly for blankets or heavy clothing.</td> </tr> <tr> <td>Soft</td> <td>Wash not-so-dirty clothing or a small amount of clothing.</td> </tr> <tr> <td>Baby</td> <td>Wash gently and rinse thoroughly for baby clothing.</td> </tr> <tr> <td>Delicate</td> <td>Wash clothing with the HAND WASH mark.</td> </tr> <tr> <td>Tub</td> <td>Clean washing / spin drying tub. (See "Tub clean".)</td> </tr> </table>	Normal	Wash normally soiled everyday clothing.	Speedy	Wash speedy for not-so-dirty clothing.	Eco	Wash daily clothing with saving electricity and water.	Jeans	Wash sturdy and heavy soiled clothing.	Air Dry	Program for reducing the time to dry. After spinning, blow air to clothing in the tub to reduce the time to dry in the shade greatly.	Blanket	Wash strongly for blankets or heavy clothing.	Soft	Wash not-so-dirty clothing or a small amount of clothing.	Baby	Wash gently and rinse thoroughly for baby clothing.	Delicate	Wash clothing with the HAND WASH mark.	Tub	Clean washing / spin drying tub. (See "Tub clean".)
Normal	Wash normally soiled everyday clothing.																				
Speedy	Wash speedy for not-so-dirty clothing.																				
Eco	Wash daily clothing with saving electricity and water.																				
Jeans	Wash sturdy and heavy soiled clothing.																				
Air Dry	Program for reducing the time to dry. After spinning, blow air to clothing in the tub to reduce the time to dry in the shade greatly.																				
Blanket	Wash strongly for blankets or heavy clothing.																				
Soft	Wash not-so-dirty clothing or a small amount of clothing.																				
Baby	Wash gently and rinse thoroughly for baby clothing.																				
Delicate	Wash clothing with the HAND WASH mark.																				
Tub	Clean washing / spin drying tub. (See "Tub clean".)																				

### Control panel / Display

- When turning on the machine, the digital timer shows "--".
- If select "Air Dry" program, the digital timer displays the air dry time, unit is MIN.
- When washing, the digital timer shows the remaining operation time, unit is MIN or Hour.
- When the preset time is set, the digital timer shows the preset time, unit is HOUR.
- When the trouble occurs, the digital time shows the trouble code.

	Press to set the preset time. You can select the time from 2-24 hours.
	Press to select the water level or add water in the tub during wash. (See "Add water".)
	Displays the water level.
	Blinks during water supply.
	Displayed for the remaining operation time.
	Displayed while setting the preset time or until the preset time comes. You can see the details of preset program by touching  until the preset time comes.
	Displayed when child lock is set. (See "Child lock".)
	<p>Press to select the spinning time. (9 min. / 7 min. / blank / 5 min. / 3 min. / Soft spin ) Default setting depends on each program.</p> <p>When selecting "Air Dry" program, you can also change the time to dry by pressing this key. (30 min. / 60 min. / 90 min. Default setting: 30 min.)</p>
	Press to select the rinse times. (4 times / 3 times / 2 times / blank / 1 time) Default setting depends on each program.
	Press to select the washing time. (20 min. / 15 min. / blank / 12 min. / 9 min. ) Default setting depends on each program. You can turn on/off the soak function by pressing this button for 2 seconds. (See "Soak function".)