

SHARP
SHARP CORPORATION

SHARP

ESX858
ESX958

Operation manual
of full-automatic
washing machine
自动洗衣机使用说明书

Thank you for purchasing our product.
承蒙购买本公司产品
深表谢意。

Please read this manual carefully before use.
Please read "Safety Precautions" carefully
before use.
Please keep this manual in a safe place.
Our product is intended for household use only.
使用前请务必阅读本说明书。
使用前请务必阅读“安全注意事项”。
使用后请保存好本说明书。
本公司产品专为家庭用户设计。

Table of contents 目录	Page 页次
● Safety Precautions 安全注意事项	2 15
● Component Parts 各部分名称	4 17
● How to Install 安装与调整指南	5 18
● Things to Check Before Wash 洗衣前须知	6 19
● Instructions Before Wash 洗衣前操作指南	6 19
● Control Panel Functions 操作面板说明	7 20
● How to Use Different Washing Programs 洗涤程序指南	9 22
● Additional Functions 附加功能操作说明	11 24
● Cleaning and Maintenance 清洁与维护操作指南	12 25
● Troubleshooting 异常 • 故障确认与处理方法	13 26
● Specifications 规格	14 27

Safety Precautions

WARNING

Do not allow children to play with or look around the washing • dehydration tub, in case they fall into the tub, they will get injured.



FORBIDDEN

While cleaning the machine body, the plug should be pulled out first. Do not plug or pull the plug with wet hand or wet cloth, so as to avoid electric shock.



PLUG OR PULL THE PLUG

Clothing stained with harmful diluting agents such as gasoline, kerosene and so on must not be put into the washing • dehydration tub.



FORBIDDEN

Before the dehydration tub completely stops, do not touch the clothing being washed. Even if the tub is running at low speed, your hand may get wrapped up and injured. Special attention should be paid to children.



FORBIDDEN TO TOUCH

Do not use power supply other than AC240V, 50Hz, so as to avoid malfunction, damage and fire.



FORBIDDEN

Do not modify the machine (except for professional repairmen). Please do not disassemble and repair the machine without permission, so as to avoid fire, electric shock, getting hurt or machine malfunctions.



FORBIDDEN TO DISASSEMBLE

Do not change the original state of power cable. Any artificial damage to the power cable could cause electric shock, electric leakage or other malfunctions.



FORBIDDEN

Do not use damaged power cable, plug and loose plug seat, so as to avoid short circuit, electric shock, fire and other accidents.



FORBIDDEN

To prevent electric shocks, fires, malfunctions and distortions, do not place the machine in a place with high-humidity (such as bathrooms), or where wind and rain may get in.



FORBIDDEN TO USE AT HIGH-HUMIDITY LOCATIONS.

Do not use water to wash components of the machine, so as to avoid short circuit and electric shock.



FORBIDDEN TO WASH WITH WATER

Use a plug seat above 13A separately. A loose plug seat or the action of sharing a plug seat with other apparatus may start a fire due to heat.



MANDATORY

To move the machine, only carry by it handle to avoid any harm or damage.



FORBIDDEN

This machine is equipped with an earthing plug. Changing the plug is not allowed. If an earthing-type receptacle is not available, customer is obligated to have it installed by qualified electrician.



MANDATORY

If gas leak, do not plug or unplug the machine. Do not use any inflammable object close to the machine.



FORBIDDEN

Clean the dust on the plug and plug seat to avoid fire.



MANDATORY

Do not approach any fire source near to a plastic component, which has the risk of starting a fire.



FORBIDDEN

规格

机型名	ESX858	ESX958
洗涤/脱水容量	8.0kg	9.0kg
额定工作状态下 洗涤噪声	≤62dB(A计权, 声功率级)	
额定工作状态下 脱水噪声	≤72dB(A计权, 声功率级)	
进水压力	0.03MPa~0.6MPa	
整机重量 (净重kg)	32	38
产品尺寸 (长x宽x高mm)	530x550x935	570x590x924

经长年使用的洗衣机的检修

	<p>有这样的状况吗?</p> <ul style="list-style-type: none"> • 有时会不运行 • 脱水运行中, 盖锁不能锁住 • 漏水 (水管、脱水桶、龙头连接处) • 有焦臭味 • 运行中有异常声音或振动 • 触摸的话, 有手麻感觉 • 电源线、插头异常的热 	<p>停止使用</p>	<p>为防止故障和事故, 请从插座上拔下电源插头, 一定要委托维修部进行检查, 检查修理费用请洽维修部。</p>
--	--	-------------	--

为不断提高产品的质量, 满足用户需求, 本公司有权对产品的规格值作适当变更, 届时将不再另行告知用户, 敬请谅解。

异常·故障确认与处理方法

异常表示

注意： 洗衣机显示如下信息时并伴随有蜂鸣声报警；若10分钟后无人处理，洗衣机将自动切断电源。以下情况有些不是故障，在委托维修前，请首先确认，若属故障，请与当地维修部或本公司销售维修服务部联系，切勿擅自拆卸修理。

显示	异常可能原因	异常处理方法	故障原因	对应故障原因汇总
E1	<ul style="list-style-type: none"> 进水压力过小 水龙头未打开 进水阀过滤网堵塞 	<ul style="list-style-type: none"> 增大水量，按启动/暂停键 打开水龙头，按启动/暂停键 清洗进水阀过滤网，排除堵塞，按启动/暂停键 	① ② ③ ④ ⑤ ⑥	①. 水位气管进水 ②. 程控器损坏 ③. 进水阀损坏 ④. 导线组件损坏 ⑤. 程控器接插件松动 ⑥. 水位传感器损坏 ⑦. 门开关损坏 ⑧. 排水阀损坏 ⑨. 牵引器损坏 ⑩. 牵引器插件松动/脱落 ⑪. 撞桶开关损坏
E2	<ul style="list-style-type: none"> 进水超过高水位极限 水位异常 	<ul style="list-style-type: none"> 程序自动调整并恢复 	② ④ ⑤ ⑥	
E3	<ul style="list-style-type: none"> 预约运行中，盖板开启 脱水时，盖板未闭合 	<ul style="list-style-type: none"> 合上盖板 	② ④ ⑤ ⑦	
E4	<ul style="list-style-type: none"> 洗衣机放置不平衡 衣物偏置，脱水不平衡 	<ul style="list-style-type: none"> 调节调整脚至洗衣机平稳 打开盖板，均匀放置衣物，合上盖板 	④ ⑤ ⑪	
E5	<ul style="list-style-type: none"> 排水管出水口过高/未放下 排水管被冻结/堵塞 排水管被弯折/压扁/扭结 	<ul style="list-style-type: none"> 放低/放下排水管，按启动/暂停键 化冰/清楚堵塞，按启动/暂停键 将排水管放顺畅，按启动/暂停键 	② ④ ⑥ ⑧ ⑨ ⑩	
E7	<ul style="list-style-type: none"> 童锁时，盖板未闭合 	<ul style="list-style-type: none"> 10秒内合上盖板，程序自动恢复并解除警报；10秒后仍未合上盖板，则自动进入排水程序，解除童锁(同时按预约和附加键)可恢复程序运行 	② ④ ⑤ ⑦	

常见非故障现象

现象	可能原因与解决方法
洗涤/漂洗中途停顿	水位传感器在检测水位，属正常现象
洗涤/漂洗中途进水	水位传感器检测到水位下降后，自动进水，属正常现象
洗涤/漂洗结束后停顿	排水延时，属正常现象
脱水时，脱水桶时停时转	程序设计的间歇脱水，属正常现象
脱水撞桶后进水漂洗	脱水不平衡程序自动调整与恢复，属正常现象
脱水结束，听到水流声	平衡环内平衡液的流动声，属正常现象
操作面板局部发热	记忆电路电子部件发热，属正常现象
中途停电，来电后不运转	已断电，需重新开启电源，按启停键或重新设置程序
按键操作不起作用	按键用力太小 启动了童锁(同时按预约和附加键)功能，需解锁程序设置的按键制约

Safety Precautions

CAUTION

Do not wash clothing treated for water resistance. Do not wash sleeping bags, bath curtains, raincoats, rain ponchos, rain covers, ski jackets, ski pants, automobile covers and other water-resistant clothing, so as to avoid abnormal vibration and other unexpected accidents.



During dehydration, the washing machine is rotating at high speed. Because water in water-resistant clothing could not be discharged instantaneously, the machine will be out of balance, causing abnormal vibration and other unexpected accidents.

Do not wash objects other than clothing, such as cabbage, sweet potato, kelp, shoes and so on, so as to avoid abnormal vibration and causing damage to the machine.



While the machine is running, do not touch the bottom with hand or foot, where there's a rotating mechanism, so as to avoid getting hurt.



Water temperature must not exceed 55°C, so as to avoid accidents of electric leakage and electric shock due to distortion or damage of plastic.



When connected to water tap, follow the instructions stated to connect the water inlet hose. Make sure inlet hose and water tap connect properly. Do not frequently remove inlet hose. Do not pull or twist drain hose.



While pulling out or plugging the plug, do not touch the metal part of the plug, so as to avoid electric shock or short circuit.



Before using, check the bottom of the product. Make sure there is no packaging material such as plastic holder still attached on the visible parts. Then only install the bottom cover.



After using the washing machine, please pull out the plug, so as to avoid electric leakage, electric shock or fire due to loose connection of plug.



Do not put heavy things on the machine, so as to avoid distortion and damage.



Please use the provided water inlet hose and drain hose, do not reuse old hose. Before using, check carefully if the connection of water inlet hose or drain hose is reliable, so as to avoid water leakage.



After using, please turn off the tap to avoid water leakage.



The base opening must not be obstructed by carpeting when the washing machine is installed on a carpeted floor.



CAUTION

- To avoid danger, if the soft power cable is damaged, it must be replaced by the manufacturer, its maintenance department or a qualified personnel.
- If powder detergent or liquid detergent adheres to a plastic component such as the top cover, wipe it away immediately; otherwise it may damage the plastic component.
- Please wash the filter frequently to keep the washing efficiency.

Component Parts

Unit

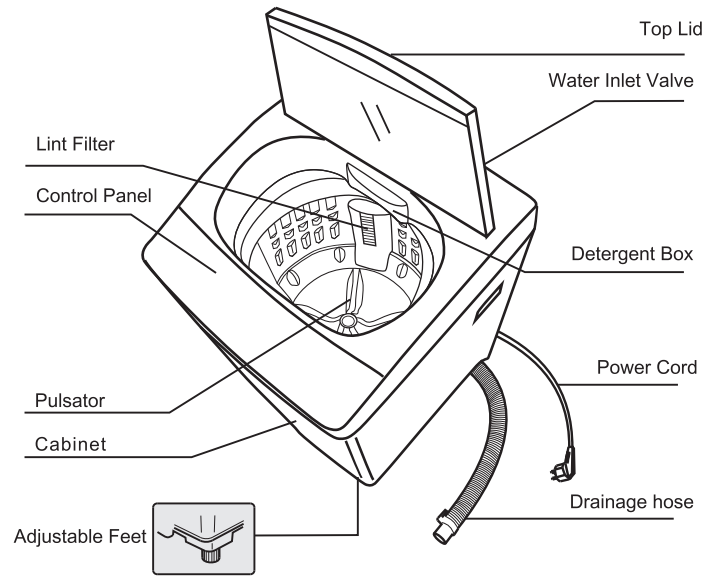

<p>For model ESX858 only</p>	<p>For model ESX958 only</p>	<p>Notes: 1. To use liquid detergent, insert the Liquid Detergent Dispenser into the detergent case before pour the detergent. 2. To use powder detergent, do not insert the Liquid Detergent Dispenser into the Detergent Case. It will cause the blockage to the detergent case.</p>
------------------------------	------------------------------	--

List of accessories

Item	Quantity
Water inlet hose assembly	1 set
Drain hose assembly	1 set
Screw	1 pc
Bottom cover	1 pc
Operation manual	1 pc
Warranty card	1 pc

清洁与维护操作指南

进水口的清洁 对洗衣机正确的清洁与维护可以延长洗衣机的使用寿命

使用时间较长后，进水口滤网可能被积垢堵塞，请按如下操作方法清洁：

1. 关闭水龙头，抬高进水管。	2. 打开电源开关，并按动水位键。	3. 按启动/暂停键。 注意 请几秒钟后关闭电源。	4. 取下进水管接头。 注意 不要扭动进水管。	5. 清洁进水阀过滤网。 注意 可将过滤网拆下清洗。
注意 使用时不能将进水阀的过滤网取下来				

过滤网的清洁 每次洗涤完毕进行清理





1. 按住过滤网的扣子往外拔。	2. 将过滤网打开并用水清洗干净。	3. 将过滤网向下推插入槽内。

日常保养

- 洗衣完毕，必须关闭自来水龙头，断开电源（如果有需要，可卸下进水管）。
- 请在使用完洗衣机后，尽快将桶内水排净，保证桶内干燥、无残水。
- 必须把电源插头拔下后保养。
- 挂好电源线和排水管。
- 用干净的软布将洗衣机桶内水珠与污渍擦干净，将盖板打开约1小时后，再盖上盖板。
- 用干净的软布将表面水渍与污渍拭去。注意不要用清洁剂，挥发剂等化学药品，以免毁坏表面。

附加功能操作指南



预约功能操作

 1. 按下电源开关。	STANDARD <input type="checkbox"/> SOAK HEAVY <input type="checkbox"/> WASH GENTLE <input type="checkbox"/> RINSE QUICK WASH <input type="checkbox"/> SPIN  2. 按程序键至所需要的程序指示灯亮。	HIGH <input type="checkbox"/> MID <input type="checkbox"/> LOW <input type="checkbox"/> E.LOW <input type="checkbox"/>  3. 按水位键至所需要的水位指示灯亮。	Rem. (Min.) Preset (Hour) 88  4. 按预约选择键至所需要的预约时间。(数码管显示预约时间)	 5. 按下启动/暂停键。
---	--	---	---	---

6. 预约开始。
 7. 当数码显示时间为设定的洗衣程序所需剩余时间时，预约结束。(预约指示灯灭，剩余指示灯亮)
 8. 洗衣结束后蜂鸣提示，30秒内电源自动断电。

桶洗净操作方式



TUB CLEAN
 CHILD LOCK

按压“电源”键接通电源后，按压“附加”键直至桶洗净灯点亮，按压“启动/暂停”键洗衣机开始工作。

童锁功能操作

CHILD LOCK







在程序运行中，同时按预约键和特色键至童锁指示灯亮，进入童锁状态。重复此操作至童锁指示灯灭，解除童锁状态。

模糊功能操作

只适合标准程序。开机后，按启动/暂停键

该功能指电脑板通过感知衣物的重量，智能地选择洗衣程序。包括水位的高低、水流节拍及洗衣的时间等。若启动运行前，按动了水位键，或者换选了其他程序则取消模糊控制功能。使用模糊功能必须保证桶内无水或者极少数水，否则会造成称重不准。

 1. 按下电源开关。	STANDARD <input checked="" type="checkbox"/> SOAK HEAVY <input type="checkbox"/> WASH GENTLE <input type="checkbox"/> RINSE QUICK WASH <input type="checkbox"/> SPIN  2. 按程序键至标准指示灯亮。	 3. 按下启动/暂停键。
---	---	---

4. 洗衣结束后蜂鸣提示，30秒内电源自动断电。
注意 标准程序下，若按动水位键，将取消模糊功能。

How to Install

Installing the bottom cover

1. Take out the bottom cover from carton box.
(For model ESX858, please find the bottom cover from inner tub.)
2. Slowly lean the unit facing up/down on soft object.
3. Push the bottom cover into the base slot.
4. Use the screw to fix the bottom cover onto the base of body (a small hole in the middle of the bottom cover), then slowly lift up the unit.

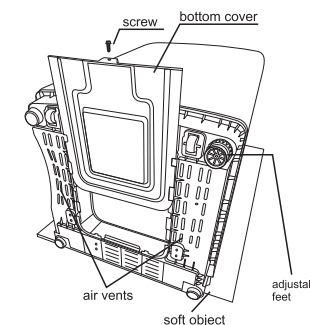

Placing the washer

1. Install the washer, adjust the Adjustable Feet if surface is not level:
 - ① Loosen up the nut on adjustable feet, adjust the feet until washer is on level.
 - ② After adjusted the washer, tighten up the nut on adjustable feet.
 2. If surface is not level, please insert step or platform to make sure washer is on level.
 3. Distance between washer and wall should be at least 5cm.
- Note** Do not place washer on step or platform to avoid washer tip over. When placing washer on carpet, make sure carpet does not block air vents.

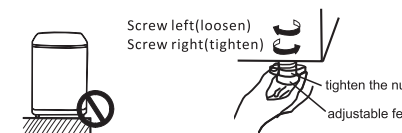

Installing the drain hose

Connect the drain hose to drain outlet, then secure it with the metal clamp.

- Note**
1. Do not seal the drain hose in the sewer pipe to avoid poor drainage or no drainage.
 2. In case of extending the drain hose, do not exceed 3m to avoid long drainage time.
 3. The height of the drain hose should not be more than 10cm.

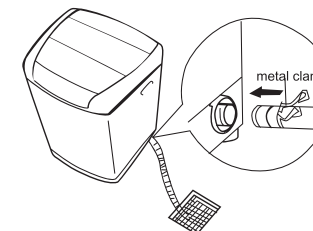

Installing the water inlet hose

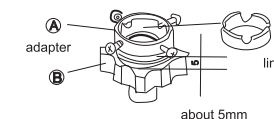
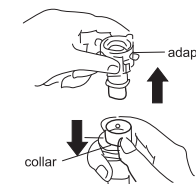
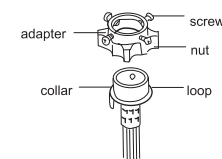

1. The joint of water inlet hose consists of 2 parts, adapter and collar.
2. Pull down the collar of the inlet hose to remove the adapter.
3. Loosen connectors A and B.

1. Length of the faucet needs to be at least 10mm, outer diameter needs to be 24mm and below.
2. Adapter can be removed if installed on a suitable faucet.
3. Spout of faucet should be smooth and round.
4. If spout of faucet is not flat, scrape it with rasp until it is flat.
5. Remove liner if outer diameter of faucet is too big

Installing the water inlet hose

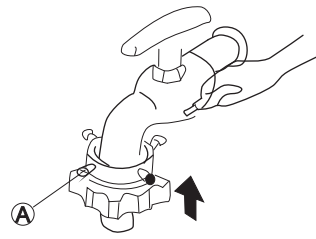

4. Loosen the four screws on connector A, fit it into the water tap. Push up the adapter so that the rubber seal can attach to the water tap tightly, then screw evenly.

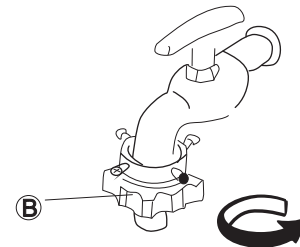

5. Screw connector B tightly so that rubber seal can attach to water tap tightly, to avoid leaking.

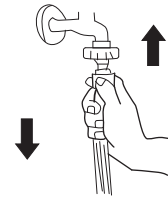

6. To attach: Pull the collar down until you see four metal balls, fit it into the adapter, let go the collar after it is fixed. To detach: Turn off the water tap, pull down the collar and remove the adapter.

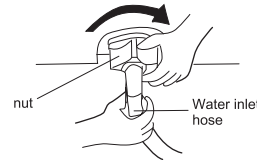

7. Tighten the other end of the inlet hose to the water inlet of washer. Caution: Tighten the nut by fastening evenly. Do not twist the hose to avoid hose cracking.

8. Turn on water faucet. If collar part is leaking, please check: (a) Is the nut of connector B screwed properly? (b) Is distance between connector A and B less than 5mm, causing rubber seal in adapter not to seal with water faucet? (c) Is head of water tap flat? (d) Is adapter A screwed properly? (e) Is adapter slant causing rubber seal not to seal properly on water faucet?

Things to Check Before Wash

- The capacity of Wash and Spin program refers to the maximum weight of dry clothes that Wash and Spin program can take on.
- Different types of fabric and size will affect the washing performance, put an adequate amount of clothes to ensure a good rotation for a more effective wash.
- Remove coins, keys, and other hard objects, close zippers, buckles to avoid scratching the interior of washing machine.
- To wash wool and delicate clothing, use washing mesh bag.
- Sort out colorfast items and heavily soiled items to wash them separately.
- The amount of softener and liquid detergent shall not exceed the top of siphon cap.

Instructions Before Wash

1. Connect water inlet hose properly, turn on water tap, put down the drain hose.
2. Before plugging in the power cord, make sure the socket is earthed.
3. Check the care label to see whether the clothes is suitable to wash by a washer.
4. Load washing machine properly, add measured detergent and softener.
5. Close the lid.

洗涤程序指南

速洗程序操作

可选水位少-中段，适用于洗涤少量比较干净的衣物



1. 按下电源开关。

STANDARD SOAK
HEAVY WASH
GENTLE RINSE
QUICK WASH SPIN



2. 按程序键至速洗指示灯亮。

HIGH
MID
LOW
E.LOW



3. 按水位键至所需要的水位指示灯亮。



4. 按下启动/暂停键。

5. 洗衣结束后蜂鸣提示，30秒内电源自动断电。

单洗/单脱程序操作



1. 按下电源开关。

STANDARD SOAK
HEAVY WASH
GENTLE RINSE
QUICK WASH SPIN



2. 按程序键至洗涤/脱水所需指示灯亮。

HIGH
MID
LOW
E.LOW



3. 按水位键至所需要的水位指示灯亮。
(单脱不能选择水位)



4. 按下启动/暂停键。

5. 洗衣结束后蜂鸣提示，30秒内电源自动断电。

漂脱程序操作



1. 按下电源开关。

STANDARD SOAK
HEAVY WASH
GENTLE RINSE
QUICK WASH SPIN



2. 按程序键至漂洗、脱水所需指示灯亮。

HIGH
MID
LOW
E.LOW



3. 按水位键至所需要的水位指示灯亮。



4. 按下启动/暂停键。

5. 洗衣结束后蜂鸣提示，30秒内电源自动断电。

洗涤程序指南

标准程序操作

可选水位低-高段适合洗涤比较脏的衬衫, 休闲裤



1. 按下电源开关。

STANDARD ■ □ SOAK
HEAVY □ ■ WASH
GENTLE □ ■ RINSE
QUICK WASH □ ■ SPIN



2. 按程序键至标准指示灯亮。(如需浸泡, 至标准+浸泡指示灯亮)

HIGH □
MID □
LOW □
E.LOW □



3. 按水位键至所需要的水位指示灯亮。



4. 按下启动/暂停键。

5. 洗衣结束后蜂鸣提示, 30秒内电源自动断电。

大物程序操作

适合洗涤毛毯和其他较厚的大件衣物



1. 按下电源开关。

STANDARD □ □ SOAK
HEAVY ■ ■ WASH
GENTLE □ ■ RINSE
QUICK WASH □ ■ SPIN



2. 按程序键至大物指示灯亮。(如需浸泡, 至大物+浸泡指示灯亮)



3. 按下启动/暂停键。

4. 洗衣结束后蜂鸣提示, 30秒内电源自动断电。

注意 1. 无水位调节功能。
2. 自动设置为高水位。

轻柔程序操作

可选水位低-高段, 适合洗涤丝织品或内衣



1. 按下电源开关。

STANDARD □ □ SOAK
HEAVY □ ■ WASH
GENTLE ■ ■ RINSE
QUICK WASH □ ■ SPIN



2. 按程序键至轻柔指示灯亮。

HIGH □
MID □
LOW □
E.LOW □



3. 按水位键至所需要的水位指示灯亮。



4. 按下启动/暂停键。

5. 洗衣结束后蜂鸣提示, 30秒内电源自动断电。

Control Panel Functions

Control Panel

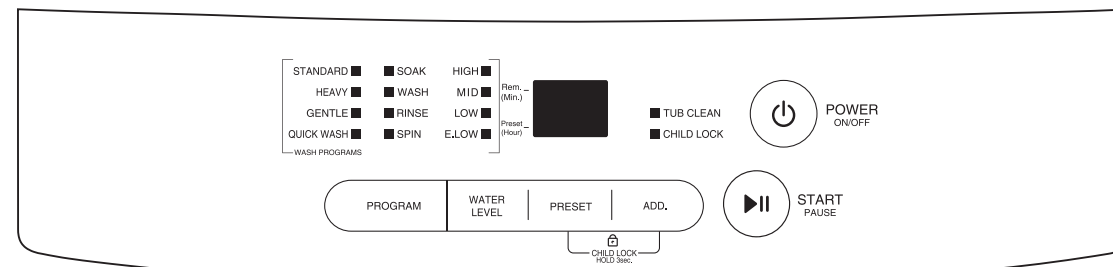

	<p>POWER: Plug the power cord, press this button, the power will be connected. Press this button again to shut the power off.</p> <p>NOTES: 1. Press POWER button to activate power, it will turn off automatically after 5 minutes of inactivity. 2. Press START/PAUSE button when machine operates, it will turn off automatically after 10 minutes of inactivity.</p>
	<p>START/PAUSE: Connect power and press this button, the chosen program will start running. Press again, chosen program will pause.</p>
	<p>* STANDARD: Default program, suitable for daily soiled clothing like shirt and pants. HEAVY: Strong washing flow, suitable for towel and other heavy clothing. GENTLE: Suitable for silk or other delicate clothing. QUICK WASH: Low water level, suitable for less dirty or light clothing. SOAK: An additional washing program, only selectable for STANDARD and HEAVY mode. After selecting, SOAK will light up together with the chosen program. Display shows "JP". When soaking, tub rotates discontinually. Soaking time sets automatically according to water level, manual setting is not available. Soaking time for water level LOW and E.LOW:20 minutes; water level HIGH and MID:30 minutes. WASH: Select for wash program. RINSE: Select for rinse program. SPIN: Select for spin program.</p>
	<p>CHILD LOCK: All buttons will not function under child lock mode, except to unlock. Alarm beeps when lid is open under child lock mode. For safety purpose, washer will drain the water if lid opens for too long. TUB CLEAN: This function is to wash the inner tub, do not put any clothes when you activate this function. For better cleaning result, you may add detergent for cleaning tub.</p>
	<p>WATER LEVEL : Choose the suitable water level according to load size. (E.LOW~HIGH)</p>
	<p>Select suitable preset time (1~24hours). PRESET: Preset time is to set the time for start washing. 1hour preset time means Program will start washing after 1 hour. PRESET is an additional function on top of other features.</p>

Control Panel Functions

Control Panel

- * Power on, press PROGRAM button for 3 seconds (there will be a sound of "beep", water level will be in HIGH, STANDARD Program will blink). Then press START to enter Water Efficiency mode. This nominated mode is recommended for normally soiled load equal to the rate capacity in the product literature.
- Fuzzy program starts display with "--"
- When program is running, display shows remaining time (Rem) in "minute"
- When PRESET mode operating, display shows preset time (Preset) in "hour"
- When SOAK mode operating, display shows "JP"
- When error occurs, display shows error code, see page 13

Things to Check Before Operating Your Washing Machine

- When selecting a washing program, choose the water level according to load size. May choose different water levels for different programs.
- Once START/PAUSE button pressed (washing program running), the selected program cannot be changed. To change washing program, turn the power off then turn on again.
- The indicator light blink while program is running. Indicator light will light up when program is selected.
- Guide for operation buttons:
 1. Other than POWER button, the rest of the button do not work when the washer is beeping; PRESET is working; or wash course ends.
 2. When washer is paused, PRESET button will not function.
 3. Other than POWER button and START/PAUSE button, the rest of the buttons will not function when wash, rinse, spin course is running.
- To avoid washer overheat which could cause thermostat to operate, please do not continuously run the washer more than 3 cycles.

Usage of Softener

- Measure the correct amount as recommended on the softener package into a cup and then pour it into the softener dispenser
- If the concentrated softener is used, dilute it with water one third of its original concentration before pouring it into the softener inlet.
- Do not leave softener in the softener inlet for long periods, it may agglomerated.
- Do not mix softener with other detergent, it may cause chemical reaction.

For model ESX858 only

- Please rotate inner tub clockwise until you can add softener into the dosing compartment conveniently.
- The auto dosing function will not work if rinse option is selected as "1".
- During the rinsing process, do not open the tub lid. On the contrary, softener will be put in ahead of time, and it will affect the result.

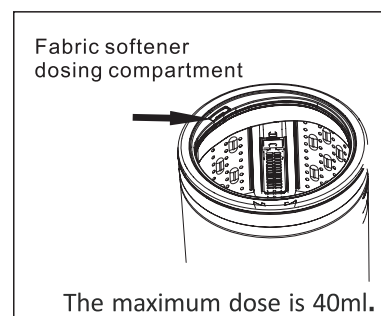

CAUTION While thermostat is operating, washer will stop functioning. Washer will resume to normal when its temperature decreases. This appliance is not intended for use by persons (including children) with reduced physical, sensory or mental capabilities, or lack of experience and knowledge, unless they have been given supervision or instruction concerning use of the appliance by a person responsible for their safety. Children should be supervised to ensure that they do not play with the appliance.

操作面板功能说明

操作部 · 显示部

- * 按下电源键，长按程序键3S（洗衣机发出“哔”声响，水位默认为高档水位，标准程序将闪烁）。按下启动键，即可进入水耗测试程序。此程序适合洗涤一般的衣物，以及与洗衣机标称相符的衣物量。
- 模糊控制开始过程，显示 "--"
- 程序运行过程中，显示剩余时间 "Min"
- 预约过程中，显示预约时间 "Hour"
- 浸泡过程中，显示 "JP"
- 出现异常时，显示异常现象信息见第13页。

操作前须知

- 在洗衣时根据洗衣量选择相应水位，不同的洗衣程序，可选水位不同。
- 一旦按了启动/暂停键（洗衣程序运行后），被设定的程序就无法改变，需要更换新的洗衣程序时，请关闭洗衣机，然后重新开启。
- 指示灯闪烁表示程序正在进行，指示灯亮表示选定了此程序。
- 按键制约说明：
 1. 蜂鸣时、预约进行中、洗衣结束时，除电源开关外其余按键均不起作用。
 2. 暂停时，预约键不起作用。
 3. 洗涤、漂洗、脱水进行时，除电源键，启动/暂停键外其它键均不起作用。
- 为避免电机温度过高而可能引起热保护器的动作，影响您的正常使用，连续洗衣请不要超过3个周期。

柔顺剂功能

- 按照柔顺剂包装上的说明，将合适的正确用量的柔顺剂先倒入小杯中，然后再将杯中的柔顺剂倒入柔顺剂投入口。洗衣机会在最后一次漂洗前加入这些柔顺剂。
- 使用柔顺剂若为浓缩型，请用3倍的水稀释后使用。
- 请不要让柔顺剂在柔顺剂注入口的放置时间过长，以避免柔顺剂结块。
- 柔顺剂不可与洗涤剂混合使用，会产生化学反应。

仅限于ESX858

- 为了便于操作，你可顺时针旋转内桶，使柔顺剂投放口位于合适位置，再倒入柔顺剂。
- 当程序只有一次漂洗时，自动投放功能无效。
- 在脱水过程中请不要打开上盖。反之，柔顺剂会提前流入桶内，影响其效果。

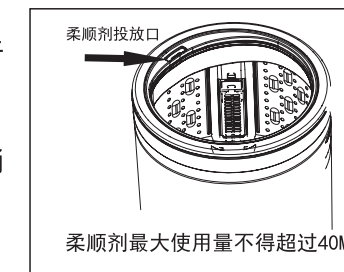

注意 热保护器工作时，电机将不运转，等待电机温度下降后恢复正常工作。

如未在他人在陪同下或指导下，身体、感官或精神有缺陷者，儿童，经验缺乏者，都不得使用洗衣机。且需确保儿童不将洗衣机作为玩物进行玩耍。

操作面板功能说明

操作部 · 显示部

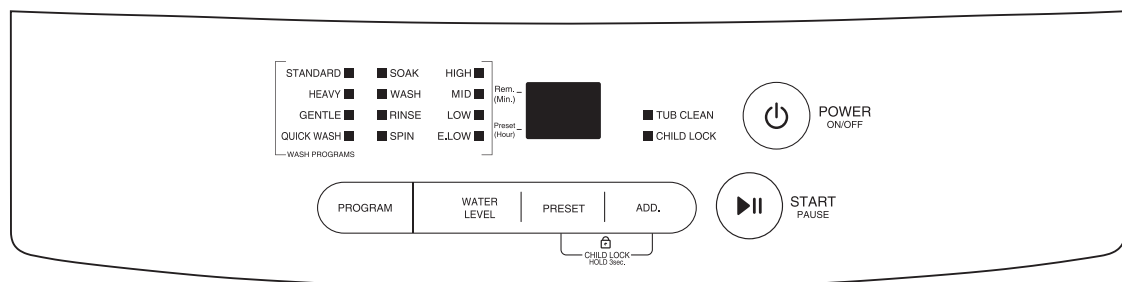

	<p>电源键：插上插座，按下此键，接通电源，再次按下此键，关闭电源。</p> <p>注意 1. 按压电源开关接通电源后，若5分钟内不按任何键，则自动关闭电源。 2. 运行中，按压“启动/暂停”键10分钟后不按任何键，则自动关闭电源。</p>
	<p>启动/暂停键，接通电源后，按下此键，选择的洗衣程序开始运行/停止，再次按下此键，选择的洗衣程序停止/开始运行。</p>
	<p>*标准：开机默认程序，适合洗涤比较脏的衬衫，休闲裤等日常衣物。 大物：水流强度适合洗涤毛毯和其他较厚的大件衣物。 轻柔：适合洗涤丝织品或内衣内裤。 速洗：水位低适合洗涤少量比较干净的衣物。 浸泡：浸泡是一种叠加洗涤功能，只适用于标准和大物程序。 选择后，浸泡与所选程序指示灯同时亮并且数码管显示“JP”。 浸泡过程中伴随间断的波轮搅拌。 浸泡时间根据所选水位自动设定，不能手动调节。 少、低段水位时浸泡时间为20分钟，高、中段水位时浸泡时间为30分钟。 洗涤：根据需要选择是否洗涤。 漂洗：根据需要选择是否漂洗。 脱水：根据需要选择是否脱水。</p>
	<p>童锁：童锁状态下，除同时按解锁键外，按任何键无效。童锁后，盖板打开则停止运行并报警，长时间开盖则进入排水，保证安全。 桶洗净：此功能为了清洁内桶，使用桶洗净程序时，不得放入任何衣物，放入适量清洗剂，效果更佳。</p>
	<p>水位键：根据衣物或程序选择合适的水位（低~高）</p>
	<p>预约键：根据需要选择合适的时间（1~24小时，以小时为单位）。 预约时间是预约开始洗涤的时间。预约选择1小时，即表示1小时后开始洗涤。预约功能是叠加在其它洗衣程序上。</p>

How To Use Different Washing Programs

Standard Program

Select water level from E.Low~High, suitable for soiled items like shirt and pant.

1. Switch power on.
2. Select Standard course by pressing Program button. (For soak, select Standard + Soak)
3. Select water level by pressing Water Level button
4. Press Start /Pause button.
5. Washing course ends with beeping sound. Power shuts off after 30s.

Heavy Program

Suitable for blankets and other big and heavy clothing.

1. Switch power on.
2. Select Heavy course by pressing Program button. (For soak, select Heavy + Soak)
3. Press Start /Pause button.
4. Washing course ends with beeping sound. Power shuts off after 30s.

Note:

1. Water Level setting is not available for this program.
2. Automatically set to High water level.

Gentle Program

Select water level from Low~High, suitable for silk and other delicate clothings.

1. Switch power on.
2. Select Gentle course by pressing Program button.
3. Select water level by pressing Water Level button
4. Press Start /Pause button.
5. Washing course ends with beeping sound. Power shuts off after 30s.

How To Use Different Washing Programs

Quick Wash Program

Select water level from Low-Mid, suitable for small load size and cleaner clothing.

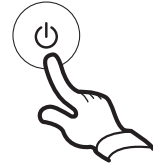

1. Switch power on.

STANDARD SOAK
HEAVY WASH
GENTLE RINSE
QUICK WASH SPIN



2. Select Quick Wash course by pressing Program button.

HIGH
MID
LOW
E.LOW



3. Select water level by pressing Water Level button



4. Press Start /Pause button.

5. Washing course ends with beeping sound. Power shuts off after 30s.

Wash/Spin Program

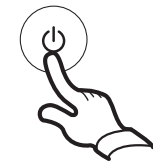

1. Switch power on.

STANDARD SOAK
HEAVY WASH
GENTLE RINSE
QUICK WASH SPIN



2. Select Wash/Spin course by pressing Program button.

HIGH
MID
LOW
E.LOW



3. Select water level by pressing Water Level button.
(Water Level selection is not available for Spin mode.)



4. Press Start /Pause button.

5. Washing course ends with beeping sound. Power shuts off after 30s.

Rinse Program

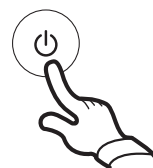

1. Switch power on.

STANDARD SOAK
HEAVY WASH
GENTLE RINSE
QUICK WASH SPIN



2. Select Rinse, Spin course by pressing Program button.

HIGH
MID
LOW
E.LOW



3. Select water level by pressing Water Level button



4. Press Start /Pause button.

5. Washing course ends with beeping sound. Power shuts off after 30s.

关于进水管安装

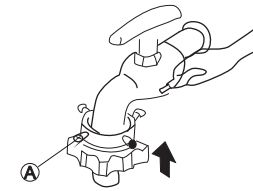

4. 旋松A部四个螺钉，将A部水平套在水龙头口上并用力向上推，使橡胶垫圈紧压在水龙头口上，然后逐个将螺钉均匀旋紧。

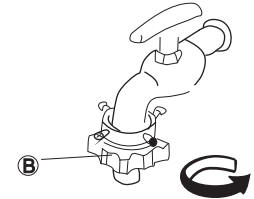

5. 将B部旋紧，使橡胶垫圈紧压在水龙头口上密封确保不漏水。

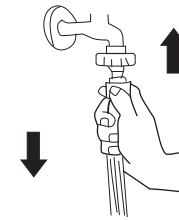

6. 结合：按下快速接头上的滑套（必须露出4个小圆球），将其插入连接座并向上推，放开滑套直至与连接座插牢。
脱离：先关闭自来水龙头，向下推滑套，拔出快速接头。

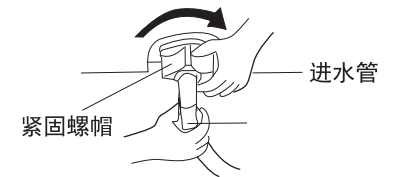

7. 将进水管的另一端紧固螺帽旋在洗衣机进水阀接头上（内有橡胶密封圈）。
注意：旋紧紧固螺帽时用力须均匀，且不能扭动进水管以防进水管弯头断裂。

8. 打开水龙头，如快速接头不良漏水，请检查：a. 连接座B部锁紧螺帽是否拧紧？ b. 连接座A、B部旋松分离是否小于5mm，使连接座内橡胶垫圈和水龙头口没有到位而无法密封？ c. 自来水龙头口平面是否平整？ d. 连接座四个螺钉是否均匀旋紧？ e. 连接座是否倾斜套在自来水龙头上，使橡胶垫圈无法和水龙头密封？

洗衣前须知

- 洗衣机的洗涤、脱水容量是指1次可洗、脱的干燥状态下洗涤物的最大重量。
- 布质的厚度、大小、种类不同，会影响实际洗涤容量，每次洗涤应放入适量洗涤物，洗涤过程中洗涤物能正常翻转为宜。
- 洗衣时务必将硬币、钥匙等硬物取出，拉链拉上，纽扣扣好，以免损坏衣物和桶体。
- 洗有绒毛和精致的衣物时，请用尼龙网包裹后洗涤。
- 易掉色和粘有油污的衣物务必与其他衣物分开清洗。
- 柔顺剂和洗涤剂注入量不得超过虹吸帽顶部

洗衣前操作指南

1. 接好进水管，打开水龙头，放下排水管。
2. 确认电源插座有可靠的接地后，将电源插头插入插座。
3. 检查衣物是否合适洗衣机洗涤。
4. 将衣物放入洗衣机，放入洗涤剂和柔软剂。
5. 关上洗衣机盖板。

安装程序指南

关于封底板安装

1. 打开纸箱，取出封底板。
(型号ESX858封底板在洗衣机桶内)
2. 将洗衣机轻轻向前/后放倒在柔软的物体上(如布、地毯等)。
3. 把封底板从洗衣机底座槽内推入到底。
4. 用螺钉把封底板固定在箱体底座上(底座前部中间有一小孔)，然后轻轻扶起洗衣机。

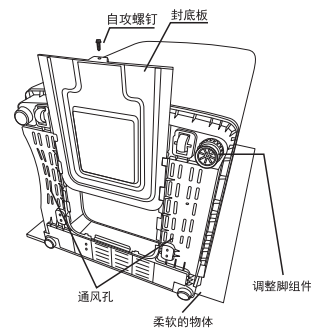

关于洗衣机放置

1. 放置本机，如果地面不平，调节调整脚高度：
 - ①先松开锁紧螺母，然后调节调整脚，将洗衣机调节至水平；
 - ②将洗衣机调节至水平后，再拧紧锁紧螺母。
2. 如地面严重不平，请自行将洗衣机垫平，使整机无法晃动。
3. 机体距离墙壁5cm以上。
放置在地毯上时，不能堵塞洗衣机底部的通风孔。

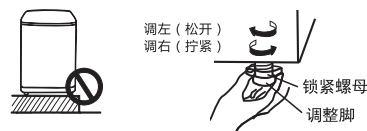

注意 严禁在高台边上放置使用，防止翻机。

关于排水管安装

将排水管完全插入排水口，并用弹簧卡圈在靠近排水口接头处固定。

- 注意**
1. 请勿将排水管密封固定在下水道中：避免在密封状态下，排水管内无法进入空气，反而引起排水不畅或不排水。
 2. 若需加长排水管，长度不能超过3m，否则会影响排水时间。
 3. 排水管放置高度不能高于底平面10 cm。

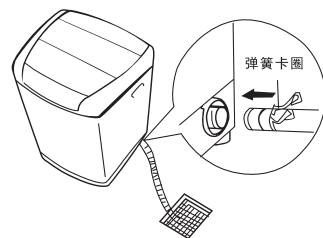

关于进水管安装

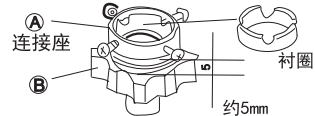
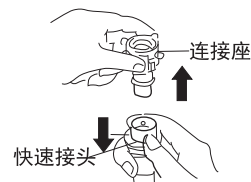
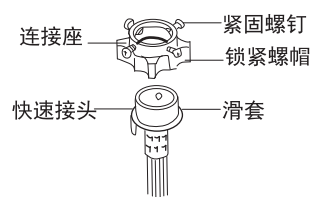

1. 进水管接头由连接座和快速接头两部分组成。
2. 安装时，按下快速接头滑套，用力拔出连接座。
3. 将连接座A、B二部旋松至5mm(约3圈)或直接脱离。

- 注意**
1. 普通水龙头出水口长度大于10mm，外径应在24mm以下。
 2. 如果使用了合适的专用水龙头，则无需安装连接座。
 3. 水龙头出水口端部外角应为圆角，表面应光滑。
 4. 如水龙头出水口不平，请先用锉刀锉平。
 5. 如水龙头外径太大，取下A部衬圈。

Additional Functions

Preset Function



1. Switch power on.

- STANDARD
- HEAVY
- GENTLE
- QUICK WASH
- SOAK
- WASH
- RINSE
- SPIN



2. Select washing course by pressing Program button.

- HIGH
- MID
- LOW
- E.LOW



3. Select water level by pressing Water Level button

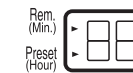

4. Select preset time by pressing Preset button (display showing preset time)



5. Press Start /Pause button.

6. Preset start.
7. When display showing remaining time, preset is end. (Preset lights off, Rem lights on)
8. Washing course end with beeping sound, power shut off after 30s.

Tub Clean Function

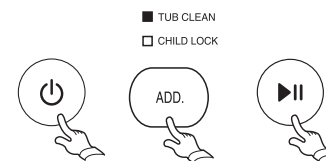

Switch power on, press "Add" button to select Tub Clean. Press START/PAUSE button to activate tub clean function.

Child Lock Function

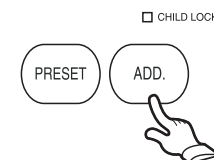

While washing course is operating, press Preset and Add. button together until the CHILD LOCK lights up to activate CHILD LOCK function. To deactivate, repeat the same step until the light goes off.

Fuzzy Function

Suitable for Standard program only. Switch on power and press Start/Pause button.

Sensor device detects load size and selects properly the washing condition such as water level, washing course, and washing time. Pressing the water level button or selecting other washing course before starting a wash will cancel Fuzzy Function. To use Fuzzy Function, please ensure there is no water or very little water in the tub.



1. Switch power on.

- STANDARD
- HEAVY
- GENTLE
- QUICK WASH
- SOAK
- WASH
- RINSE
- SPIN



2. Select Standard course by pressing Program button.



3. Press Start/Pause button.



4. Washing course ends with beeping sound. Power shuts off after 30s.
- Caution: Pressing Water Level button while washing course is operating will cancel Fuzzy Function.

Cleaning and Maintenance

Cleaning Water Inlet

Proper care of your washer can extend its life.

After long usage time, water inlet filter may be blocked by dirt. Please follow instructions below to clean the filter:

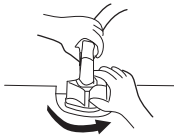
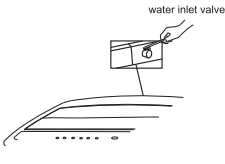
				
1. Shut off the water faucet, lift the hose up.	2. Switch power on, press Water Level button.	3. Press Start/Pause button. Caution: Switch power off after few seconds.	4. Remove water inlet hose. Caution: Do not twist the hose.	5. Clean the inlet valve filter. Caution: The filter can be removed and washed.

Note Do not remove the inlet valve filter when using the washing machine.

Cleaning Lint Filter

Clean it each time washing is finished.

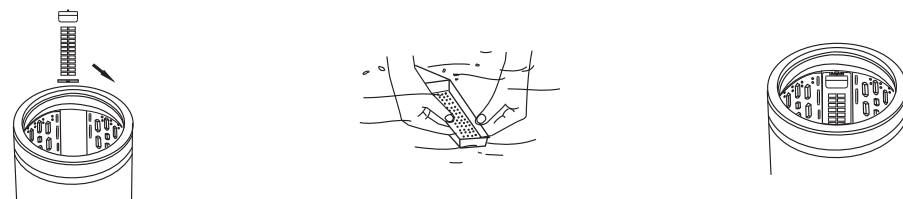

1. Press the shaft and pull the filter out.
2. Open the filter and clean it with water.
3. Plug the filter towards the wall with the fixing slot.

Maintenance

1. After wash course ends, turn off the water tap, shut the power off. Remove water inlet hose if necessary.
2. Please drain the tub completely. Make sure the tub is dry and there is no water residue.
3. Unplug the washer before maintenance.
4. Hang the hose and power cord properly.
5. Use a soft cloth to wipe away the water and stain inside the tub, open the lid for 1 hour then close the lid back.
6. Use a soft cloth to clean the water and stain on the washer body. To avoid damage to the body, do not use detergents, solvents, etc.

各部分名称

本机

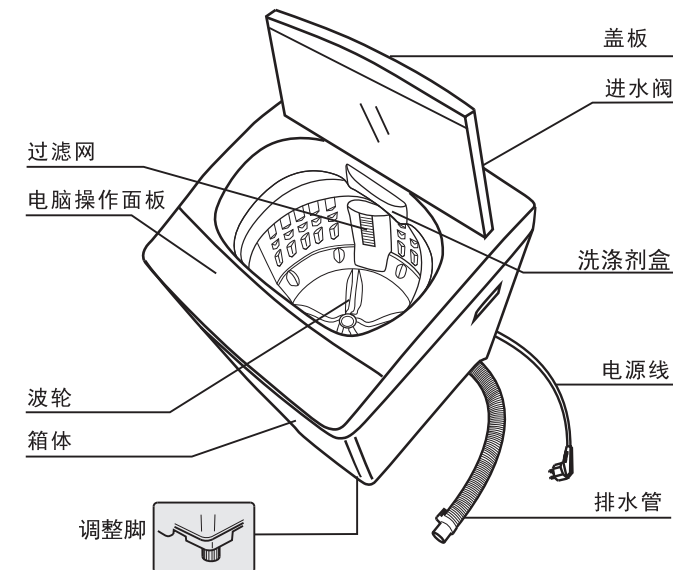

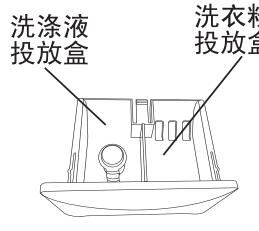
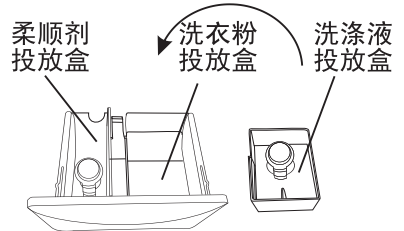
<p>仅限 ESX858</p>  <p>洗涤剂投放盒 洗衣粉投放盒</p>	<p>仅限 ESX958</p>  <p>柔顺剂投放盒 洗衣粉投放盒 洗涤剂投放盒</p>	<p>注意:</p> <ol style="list-style-type: none"> 1. 当需要使用洗涤剂时, 请将洗涤剂投放盒放入洗衣粉投放盒内 2. 当需要使用洗衣粉时, 请不要将洗衣粉放入洗涤剂投放盒内, 否则会把洗涤剂投放盒堵塞。
--	---	---

附件清单

名称	数量
进水管 (含接头)	1件
排水管	1根
螺钉	1根
封底板	1块
使用说明书	1本
保修卡	1份

安全注意事项

注意

- 不要洗涤或脱水经防水处理的衣物。不要洗涤或脱水睡袋、浴帘、雨衣、雨布、雨罩、滑雪衫、滑雪裤、车罩等防水性衣物，和易浮起的洗涤物，以免引起异常振动和其他意外事故。



脱水时洗衣机高速运转，防水性衣物中的水一瞬间无法排出，洗衣机将失去平衡，产生异常振动和其它意外事故。

- 请勿用于洗涤衣物以外的物品，如：卷心菜、白薯、海带、鞋子等。以免引起异常振动，损坏机器。



禁止

- 运转中，手、脚不要伸入底部，下有旋转机构，会因此受伤。



禁止接触

- 使用温水洗涤时不要超55℃，以免因塑料变形、损坏导致漏电、触电事故。



禁止

- 当洗衣机与水龙头连接时，请务必按指示标识正确连接洗衣机的进水管。必须确保水龙头与进水管接头连接正确可靠，请勿经常插拔进水管。请勿用力扭转或拉拽排水管。



必要

- 插、拔插头时，手不要触及插头金属部位，以防发生触电、短路。



必要

- 在使用前，请先检查产品底部，确认没有包装材（比如一个塑料支架），再安装底板。



必要

- 洗衣机使用完毕后，请拔下电源插头，防止因松动造成的漏电、触电、火灾。



插拔插头

- 机上不能放置重物，以免造成变形损坏。



禁止

- 请务必使用产品中自带的新进水管与排水管，旧的不能重复使用。使用前认真检查进水管、排水管连接是否可靠，防止漏水。



必要

- 使用完毕后，请关好水龙头，防止漏水。



必要

- 若洗衣机置于地毯之上，请确保底盖的开合不受影响。



必要

注意

- 本机电源线为Y型连接，如果电源软线损坏，为避免危险，必须由制造厂或其维修部或类似的专职人员来更换。
- 粉末洗涤剂、液体洗涤剂粘附在上盖等塑料部件上时，请马上擦拭干净，否则会损伤塑料部件。
- 洗涤时为了不影响过滤效果，洗衣机桶内的过滤网应定期清洗，以保证过滤效果。

Troubleshooting

CAUTION: If there is error happen, washer will displays error code with beeping sound. If error do not fix after 10 minutes, washer will turn off automatically. Some of the circumstances may not be a fault, please check before sending for repairs. If it is a fault, please contact our service department, do not try to disassemble the washer or repair the washer by yourself.

Display	Problem	Solution	Reason	Summary of Reason
E1	<ul style="list-style-type: none"> • Water supply is too low. • Water faucet is shut off. • Filter net of water Inlet valve blocked. 	<ul style="list-style-type: none"> • Increase water supply. press START/PAUSE button. • Turn on the water faucet. press START/PAUSE button. • Wash the filter net, remove blockage, press the START/PAUSE button. 	①② ③④ ⑤⑥	<ul style="list-style-type: none"> ① Pipe leaking ② PWB breakdown
E2	<ul style="list-style-type: none"> • Water level exceeded the highest limit of the tub. • Abnormal water level. 	<ul style="list-style-type: none"> • Program will automatically adjust the water level and resume function. 	②④ ⑤⑥	<ul style="list-style-type: none"> ③ Inlet valve breakdown ④ Circuit board breakdown
E3	<ul style="list-style-type: none"> • Lid open when running PRESET mode. • Lid do not close when Spin mode is operating. 	<ul style="list-style-type: none"> • Close the lid. 	②④ ⑤⑦	<ul style="list-style-type: none"> ⑤ Connection of control panel loosen off
E4	<ul style="list-style-type: none"> • Washing machine incline. • Clothes is collected on one side, causing unbalanced spin. 	<ul style="list-style-type: none"> • Adjust the adjustable leg. • Open the lid and distribute the clothes evenly. 	④⑤ ⑪	<ul style="list-style-type: none"> ⑥ Water level sensor breakdown ⑦ Lid switch breakdown
E5	<ul style="list-style-type: none"> • Draining position is relatively high. • Drainage hose is frozen or blocked. • Drainage hose is bent, squeezed, tangled. 	<ul style="list-style-type: none"> • Lower down the drain hose, press START/PAUSE button. • Defreeze/unblock drainage hose, press START/PAUSE button. • Smooth out drainage hose, press START/PAUSE button. 	②④ ⑥⑧ ⑨⑩	<ul style="list-style-type: none"> ⑧ Drainage system breakdown ⑨ Retractor breakdown
E7	<ul style="list-style-type: none"> • Lid do not close when child lock is on. 	<ul style="list-style-type: none"> • Close the lid in 10s and program will resume itself; if lid is still open after 10s, machine will start draining. To resume, deselect CHILD LOCK (press PRESET and ADD. button) mode. 	②④ ⑤⑦	<ul style="list-style-type: none"> ⑩ Connection of retractor loosen off ⑪ Stop switch breakdown

Common non-fault phenomenon

Phenomenon	Possible reason and solution
Program stops during WASH/RINSE mode	Water detector is working, it is normal.
Water inlet during WASH/RINSE mode	Water detector detects low water level, inlet water automatically.
Program stop after WASH/RINSE mode	Spin mode delay, it is normal.
When spinning, tub rotates discontinuously	Program designated to be intermittently paused.
During SPIN mode, tub knocking and water start supply and enter RINSE mode	Unbalance spinning causes program to autocorrect and resume, it is normal.
Sounds of water flowing after SPIN mode end	It is the sound of the fluid inside balance ring, it is normal.
Control panel heating up	The memory part of PWB heating up, it is normal.
Power stops, not restart after power supply resume	Power cut off, need to turn on power supply, press START/PAUSE button or reselect program again.
Operation button not working	Press too soft. CHILD LOCK (press PRESET and ADD.button) mode is on, deselect it.

Specifications

Model Name	ESX858	ESX958
Capacity	8.0kg	9.0kg
Wash Noise	≤ 62dB(sound power level)	
Spin Noise	≤ 72dB(sound power level)	
Operating Water Pressure	0.03MPa~0.6MPa	
Net Weight(kg)	32	38
Dimension (WxDxH)	530x550x935	570x590x924

Inspecting a washing machine that has been used for many years.

 <p>Check</p>	<p>Are there situations like these?</p>	<ul style="list-style-type: none"> • Doesn't run sometimes. • When spinning, lid cannot be locked. • Water leak (water hose, spinning tub, tap connection). • There's a burning smell. • There's an abnormal sound or vibration during running. • Your hand feels numb while touching the machine. • Power cable or plug is unusually hot.
--	---	---

 <p>Stop using the machine</p>	<p>To avoid a fault or an accident, please pull out the plug from the plug seat. Be sure to entrust the maintenance department to check it, and consult the maintenance department for check and repair fees.</p>
---	---

To consistently improve quality of our products, we reserve the right to modify product specifications without prior notice. We appreciate your kind understanding and continuously strive to exceed customer expectations.

安全注意事项

警告

<p>不要让幼儿玩弄、张望洗涤·脱水桶,一旦跌入桶内会受伤。</p> <p style="text-align: center;"> 禁止</p>	<p>脱水桶完全停转前,绝对不要用手触摸清洗物,即使低速转动时,手也会被衣物缠绕而受伤。对儿童要严加注意。</p> <p style="text-align: center;"> 禁止接触</p>
<p>洗涤·脱水桶内绝对不能放入沾有化学试剂或汽油、煤油等有害稀释剂的清洗物,一旦放入,有引发爆裂、火灾的可能。</p> <p style="text-align: center;"> 禁止  易燃物</p>	<p>不要任意改变电源线原有状态,也不要使电源线过分弯曲,过度拉伸,扭转,捆扎,改造或受重物重压,夹入。电源线受到任何人为的损伤会造成触电、漏电或其他故障。</p> <p style="text-align: center;"> 禁止</p>
<p>不要使用交流240V,50Hz以外的电源,以免造成故障、损坏和火灾。</p> <p style="text-align: center;"> 禁止</p>	<p>绝不能将接地线接在煤气管,自来水管,有线电视线或者避雷针的接地线上。接地线标称截面不得小于0.75mm²。</p> <p style="text-align: center;"> 禁止</p>
<p>为避免危险,除专业修理人员外,请不要自行改造。请不要擅自进行分解,修理,以免造成火灾、触电、受伤或机器故障。</p> <p style="text-align: center;"> 禁止分解</p>	<p>不要使用受过损伤的电源线、插头及松动的插座,以免引起短路、触电和起火等事故。</p> <p style="text-align: center;"> 禁止</p>
<p>为保证电气安全和部件不锈蚀,不要放置在浴室和风雨所及的场所等高湿地方,否则会有触电、火灾、故障和变形的可能。</p> <p style="text-align: center;"> 高湿场所禁止使用</p>	<p>清洗本机各部分时,不要用水冲,以免引起短路和触电。</p> <p style="text-align: center;"> 禁止水洗</p>
<p>本机选用三芯电源线,使用时配13A两极带接地插头,单独使用13A两极带接地插座。插座松动或与其它电器产品共用同一插座可能因发热而引起火灾。</p> <p style="text-align: center;"> 必要</p>	<p>不要抓住拎手外的其它部分(如面框)来搬运洗衣机,以免受伤或毁坏洗衣机。</p> <p style="text-align: center;"> 禁止</p>
<p>洗衣机接地线直接安装在插头上,不允许擅自更改插头。如室内插座无接地线,必须请专业技术人员安装,妥善引出接地。</p> <p style="text-align: center;"> 必要</p>	<p>任何火种绝对不要靠近塑料部件,有引起火灾的危险。</p> <p style="text-align: center;"> 禁止</p>
<p>机身清洗时应先拔去电源线插头,不要用湿手、湿布去插、拔电源线插头,以防触电。请勿由线端拔取插头,以免损坏电源线,发生触电,短路和引起火灾。</p> <p style="text-align: center;"> 插拔插头</p>	<p>当煤气,易燃气体泄露时,不要插拔洗衣机电源插头,切勿靠近洗衣机使用可燃性化学制品。</p> <p style="text-align: center;"> 禁止</p>
	<p>电线插头、插座有灰尘时请仔细用干布擦拭,以免引起火灾。</p> <p style="text-align: center;"> 必要</p>