

SHARP

Front Load Washing Machine

ES-FH85BG-W
ES-FH95BG-W
ES-FH105BG-W

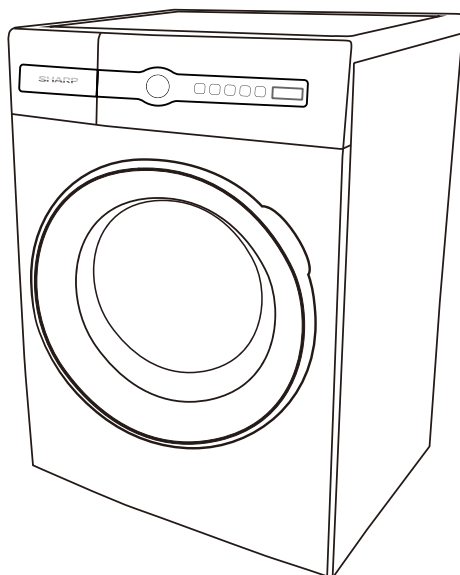

Operation manual

Thank you for purchasing our product.

Please read this manual carefully before use.

Please read Safety Notice carefully before use.

Please keep this manual in a safe place.

Our product is specially designed for household use only.

CONTENTS

INSTRUCTION BEFORE WASHING

SAFETY NOTICE	2~3
INSTALLATION INSTRUCTIONS	4~9
NAME OF PARTS	10
ACCESSORIES	10

OPERATION INSTRUCTION

SPECIFICATION SHEET	11
LOCK AND UNLOCK METHOD	12
INTRODUCTION TO DETERGENT BOX	13
INTRODUCTION TO CONTROL PANEL	14~15
PROGRAM INTRODUCTION	16~19
EXTRA OPTIONS AND FUNCTIONS	20

CLEAN AND MAINTENANCE

CLEAN AND MAINTENANCE	21~22
NON-FAILURE CONDITION	23
TROUBLESHOOTING GUIDE	24



SAFETY NOTICE (be sure to observe)

- To protect the user and other people's health and property, be sure to observe the following safety notice.









WARNINGS

Please read this part carefully for proper operation before using your machine.



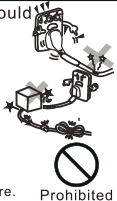







- The precautions stated here are classified as "Warning" and "Attention" according to the damage and the emergency caused by misoperation, and are described respectively in line with the marks below.

 Warning	This indicates that the failure to follow the instructions can cause serious injury or death.
 Attention	This indicates that the failure to follow the instructions can cause the minor injury or damage to the product..

		
This mark indicates the content of warning or attention.	This mark indicates the prohibited action.	This mark indicates the compulsory action to be carried out.

 Warning	
<ul style="list-style-type: none">  Dismantling, repair or alterations should only be carried out by professional technician as otherwise you may be subject to electric shock, may cause fire or get injured. 	<ul style="list-style-type: none"> This washing machine is equipped with the electricity wire with bielectrode grounding socket. The creepage protector shall be used if possible.
<ul style="list-style-type: none"> Electricity supply must be unplugged with dry hands. Otherwise, this may cause electric shock. 	<p>To prevent electricity leak which may cause injuries.</p> 
<ul style="list-style-type: none"> Damaged or loosen wire or plug should not be used. Otherwise electric shock, short circuit or fire may take place. Do not damage wire. Do not damage or alter the wire forcibly bend, pull twist or handle the wire. Beside, please do not put weigh on or trap the wire. 	<ul style="list-style-type: none"> Please use the single socket with special voltage and current matched with plug marked specification. The share of the same socket with other electric appliances may cause fire due to excessive.
<ul style="list-style-type: none"> Do not put water in direct contact with the unit during maintenance and repair. This may cause short circuit or electric shock. 	<ul style="list-style-type: none"> Thoroughly wipe the power plug when dirt is adhering the prong or around the base of the prong. Failure to do so may cause a fire.
<ul style="list-style-type: none"> Do not put gasoline, benzine, alcohol, thinner of fabrics with these stains into or near to the washing machine. To prevent fire or explosion which may cause injuries. 	<ul style="list-style-type: none"> Washing machine should not be installed in humid place or in places exposed to wind and rain. Otherwise, electricity leak causing electric shock or fire may occur. 
	<ul style="list-style-type: none"> This washing machine is strictly prohibited to get close to the locations with candle, mosquito-repellent incense, dog-end or other kinds of open flame. To avoid injuries caused by the lock damage. Do not operate the machine when there is gas leak. 

⚠ WARNINGS

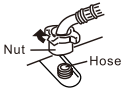
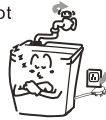
<ul style="list-style-type: none"> ● Keep child away from the washing spinning basket and do not place box or shelves next to the washing machine. Children may fall into the basket resulting in injuries. This appliance is not intended for use by persons (including children) with reduced physical, sensory or mental capabilities, or lack of experience and knowledge, unless they have been given supervision or instruction concerning use of the appliance by a person responsible for their safety.  <p style="text-align: right;">Prohibited</p>	<ul style="list-style-type: none"> ● The glass door becomes hot in process of high-temperature washing . Do not touch the door when the machine is on, especially children. ● If you need to open the door during high-temperature washing program, wait until the temperature drop to safe standard, and the door unlocked automatically. ● Packing material may be dangerous to kids, please keep all packing material (plastic bag foam etc) far away from the kids.  <p style="text-align: right;">Prohibited</p>
<h2>⚠ Attention</h2>	
<ul style="list-style-type: none"> ● Do not pull the wire from the socket when unplugging the unit. To avoid electric shock or fire caused by short circuit .  <p style="text-align: right;">Prohibited</p>	<ul style="list-style-type: none"> ● Please unplug the unit when not using the unit for a long period of time. Electric shock or leakage may occur due to deformation of plastic parts of the unit. 
<ul style="list-style-type: none"> ● Electricity supply must be unplugged with dry hands during maintenance and repair. Otherwise, electric leakage causing injuries may occur. ● If the power cord or supply cord is damaged, the manufacturer or its service agent or similarly qualified person must replace it in order to avoid a hazard. 	<ul style="list-style-type: none"> ● Water of above 50°C should not be used for washing . Electric shock or leakage may occur due to deformation of plastic parts of the unit.  <p style="text-align: right;">Prohibited</p>
<ul style="list-style-type: none"> ● Do not wash, rinse and spin the water proof fabric or cloth. Sleeping bag, raincoat, cover of skiing, utilities, bicycles, cars and motors. Otherwise may lead to injury by abnormal vibration during spinning or damage the washing machine, wall, floor and clothes.  <p style="text-align: right;">Prohibited</p>	<ul style="list-style-type: none"> ● Do not stand on or put weight on the top of the unit. Otherwise, deformation and damage may occur and causing injuries. ● Two people are required in moving or transportation.  <p style="text-align: right;">Prohibited</p>
<ul style="list-style-type: none"> ● Keep hands and feet away from the bottom of washing machine when it is working. Parts in working under the product may cause injuries.  <p style="text-align: right;">Prohibited</p>	<ul style="list-style-type: none"> ● Check water supply hose connection by turning on the water before washing. To prevent damages caused by possible water leakage due to loosen screw or not tightly. ● The new hose-sets supplied with the appliance are to be used and that old hose-sets should not be reused. ● Do not block the ventilation openings on the bottom of washer by carpeting when the washer is installed on a carpeted floor. 
<ul style="list-style-type: none"> ● Water supply hose should be tightly screwed to the unit. Failure to do so may result in water leakage. Used for a long period of time, the unit may result in water leakage caused by loosen union nut. So please check it in time and screw tightly again.  <p style="text-align: right;">Nut Hose</p>	<ul style="list-style-type: none"> ● Please turn off the water tap when not using the unit. To prevent damages caused by water leakage. 

INSTALLATION INSTRUCTIONS

Unpacking the washing machine

CAUTION: EXTREMELY HEAVY!

- A team lift or mechanical aid is required when moving this appliance.
- Keep the washing machine as upright as possible during transportation.
- This product has been packaged to protect it against transportation damage. Remove all packaging materials from inside the drum and around the appliance.
- Keep the original packaging carton and materials in a safe place. It will help prevent any damage if the product needs to be transported in the future, and you can use it to store the appliance when it is not in use. In the event that the carton is to be disposed of, please recycle all packaging materials where possible.
- Plastic wrapping can be a suffocation hazard for babies and young children, so ensure all packaging materials are out of their reach and disposed of safely.
- Carefully lift the washing machine and remove the base packing. Make sure the base protection device is removed together with the bottom piece. If not, lay the unit down on its side, then remove the small foam piece from the base of the unit manually.
- Remove any tapes securing the cord and drain hose.
- Remove all accessory parts from the drum.

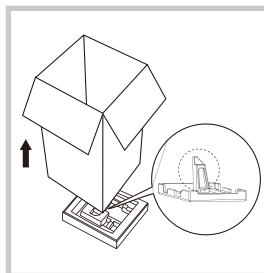

Checking the package contents

- Check all parts of the package against the scope of delivery list on the previous page and ensure you have received all items.
- Check the washing machine for any damage from transportation. Unwind the power cord to its full length and inspect it for damage. **Do not use the appliance if the appliance or its cord has been damaged or is not working properly.** In case of damage, or if anything is missing, contact our after sales support centre for advice on examination, repair or return of the damaged product.
- Read this manual to familiarise yourself with all the parts and operating principles of the wash. Pay particular attention to the safety instructions on the previous pages.

WORKING CONDITION

- Do not operate the washing machine in temperatures outside its normal working condition (0–40°C). Using it in temperatures below 0°C may damage the machine's inlet valve and draining systems.
- If the machine is stored in an area where the temperature drops to below 0°C, transfer it to an area with a warmer ambient temperature before use and ensure no residual water is frozen in hoses and pipes.
- Domestic use only: The appliance is designed for private household use only. It is not suitable for commercial, industrial or trade use.

INSTALLATION INSTRUCTIONS

Selecting the location

Before installing the appliance, make sure the location meets the following requirements:

- The surface is rigid, dry and level – if it is not level, please adjust the levelling legs (see page 6).
- The position is protected from direct sunlight, water and weather.
- There is sufficient ventilation.
- There is 100mm space between any walls and the furthest protruding part of the machine.
- The room temperature is above 0°C.
- The position is at least 200mm from heat sources.
- Ensure that the appliance shall be installed so that there is a distance of at least 200 mm between the appliance enclosure and external heat sources, such as appliances containing heating elements.
- The machine will not stand on the power cord.
- The area is not carpeted (if this cannot be avoided, place a plastic mat underneath the machine and make sure any ventilation openings in the base are not obstructed).
- Installation surface: This washing machine must be installed on a flat, even and stable ground to avoid overturning during use or maintenance. Do not place it on carpet. If the machine must be positioned on carpet, place a plastic mat underneath the machine and make sure any ventilation openings in the base are not obstructed.

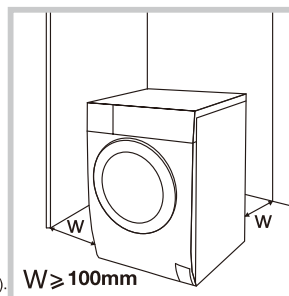

Do **NOT** install the appliance:

- Behind a lockable or sliding door, or a door with a hinge on the opposite side of the machine, in such a way that a full opening of the appliance door is restricted.
- In a tight-fitting cabinet.

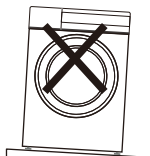

1. On the sloping ground



2. On the platform and the bracket



3. On the concavo - convex ground

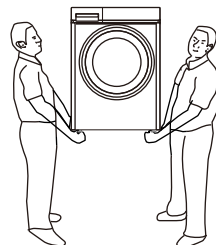

Transportation

Two people are needed to carry the machine.
One person on one side carries the machine by holding the machine feet.

INSTALLATION INSTRUCTIONS

Remove the bolt used to fix the machine in transportation

To protect the machine in transportation, there are 4 bolts inserted into the inner part of the machine. Remove these bolts before use. (Otherwise there will be strong shock, noise, and disfunction in spin process.)

1. Unscrew the bolts that are fixed before transportation by spanner (4 bolts)
2. Remove the bolts horizontally.
3. Fit the lid into the holes.

- Let the sales force or professional maintenance worker to install the machine.
- Keep the dismantled bolts carefully, you will need them in house moving.
- As the picture shows, please be sure to confirm that the base protection device is not stuck at the bottom of the washing machine before use, otherwise it will affect the normal use of washing machine.

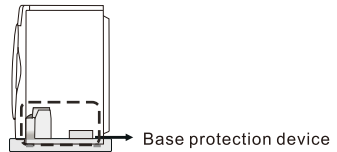
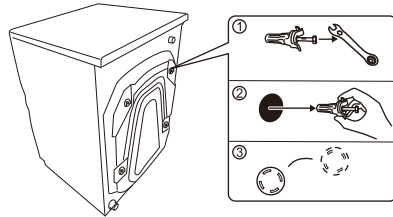

Adjust the machine horizontally

There will be strong shock, noise, and disfunction in operation if the washing machine is not steadily installed. Please adjust the front adjustable leg.

Methods are as follows:

1. Check whether the washer is on a level surface using a plumb line as shown in below figure.
 - The washer is on level ground floor if the Frame line of washer is parallel with the plumb line.
2. Adjust the Adjustable Leg of washer if necessary to make the washer level as shown in below figure.
3. Put your hands on the washer diagonally, press and shake the washer slightly to make sure that the washer is steady.

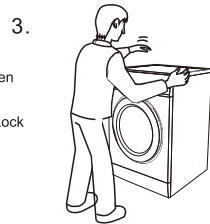
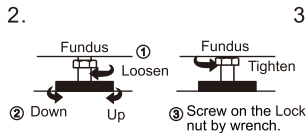
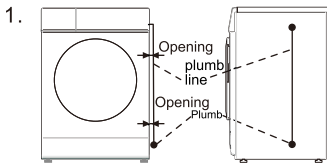

INSTALLATION INSTRUCTIONS

Connecting the Supply Hose

1. Check that sealing washers are firmly seated.
2. Attach the curved end of the hose to the inlet valve of the washing machine, Tighten the coupling nuts securely by hand.
3. Attach straight end of the hose to the tap. Tighten the coupling nuts securely by hand.
4. Turn on the taps and check for leaks. Tighten the coupling nuts firmly if there is any leakage. If water pressure is strong, close the water tap completely then open it slightly.

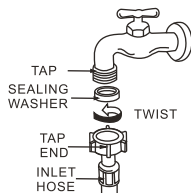

CAUTIONS:

- Do not use water which is hotter than 50°C.
- Do not connect to the hot water supply.
- If your faucet is not suitable, please consult your dealer.

Installing Water Supply Hose to the Washer

Turn the nut clockwise till the nut turned tight while holding the hose.

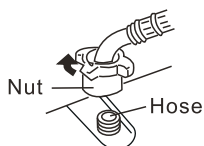

Turn the nut counterclockwise after turning the faucet off when you want to detach the water supply hose.

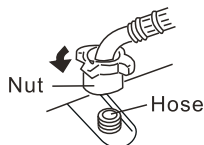

INSTALLATION INSTRUCTIONS

Rat cover installation (only for models with this part)

ATTENTION:

- Please install before removing the transport fixing bolts, installation requires at least two people to carry out the operation.
- Before installing the rat cover, the tap must be turned off and the power cable disconnected from the external power outlet, the inlet pipe from the inlet tap and the drain pipe from the drain outlet.

The installation steps are as follows:

1. Remove the rat cover and remove the double-sided adhesive stickers from around the rat cover.

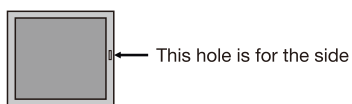

2. Tilt the washing machine backwards, Slowly lower the washing machine onto a cushioned surface, taking care that the operating panel of the washing machine is facing forward.

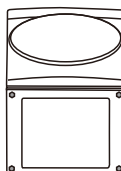

3. Place the sound-absorbing foam on the rat cover towards the inside of the washing machine, with the positioning square holes on the left and the screw holes around the backing plate aligned with the screw holes in the base plate of the washing machine. Press around the rat cover to attach it to the base plate of the washing machine.

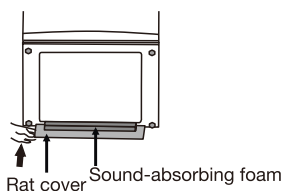

4. Fix the left and right sides of the rat cover and the rear side with special screws (large round cap screws), after the fixing is completed lift the washing machine gently and place it smoothly.

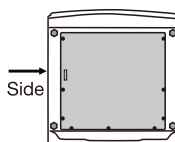

INSTALLATION INSTRUCTIONS

Installing the drain hose

WARNING!

- Do not kink or protract the drain hose.
- Position the drain hose properly in order to prevent water spillage onto the floor and potential damage.
- Never immerse the end of the drain hose in water.

The drain hose is installed at the back of the machine. For drainage of the washing water, you can install the other end of the hose three different ways, as illustrated:

- Lead the drain hose into a drain spout (1).
- Affix the drain hose into a branch drain pipe of the laundry sink (2).
- Lead the drain hose into a sink/basin, using the drain hose support at the back of the machine, and secure it with a rope or tie (3). To ensure proper drainage when the washing machine is in use, the height of the drain hose must not be higher than 100cm above ground.

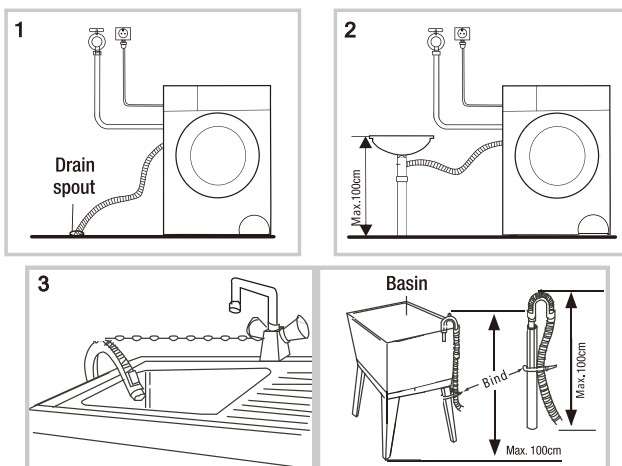

- When the washing machine is not in use, you may leave the drain hose at the back of the machine, using the hose clips to keep it in place.

WARNING!

- If the drain hose is too long, do not force it into the washing machine as it will cause abnormal noise.
- Never lay down the drain hose as water will be discharged.
- Be sure the drain hose is properly routed so it will not kink or lift off the sink.
- Leave the drain hose affixed to the back of the machine; do not remove the hose buckles.
- Do not overload the washer; its maximum capacity is 8.5kg/9.5kg/10.5kg.

NAME OF PARTS

ATTENTION

- We suggest the user to run the tub clean program before the 1st time washing.
- Don't forget to close the water tap and take down the power plug to avoid any flood and fire disaster.

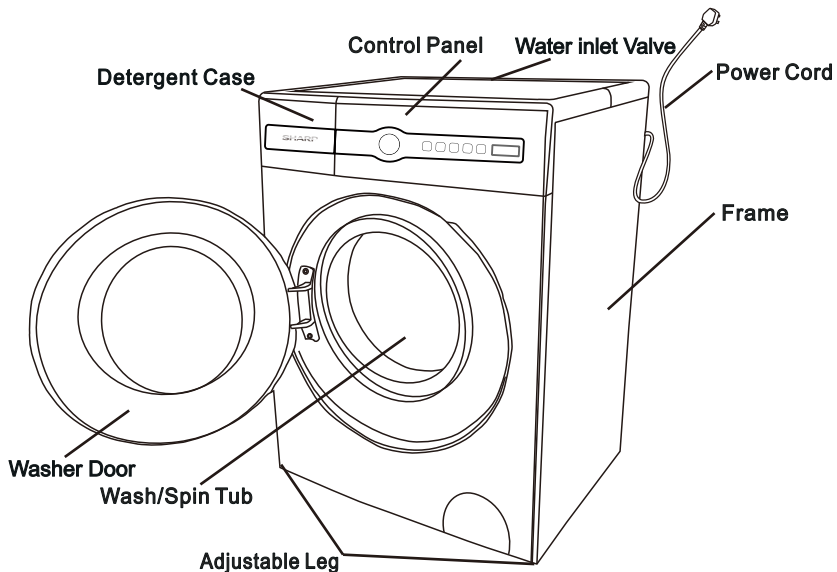

ACCESSORIES

Operation manual	Water Supply Hose	Lid (4Piece)	Spanner	The Screw of Rat Cover (9Piece)	Rat Cover (1Piece)

SPECIFICATION SHEET

Model	ES-FH85BG-W	ES-FH95BG-W	ES-FH105BG-W
Dimensions	600×580×850	600×580×850	600×635×850
Maximum mass of wash cloth	8.5kg	9.5kg	10.5kg
Power Source	220-240 V~50Hz	220-240 V~50Hz	220-240 V~50Hz
Power Consumption(WASH)	85 W	105 W	105 W
Power Consumption(SPIN)	350 W	500 W	530 W
Power Consumption(WARM)	1700 W	1700 W	1700 W
Maximal Input Power	1800 W	1800 W	1800 W
Required Water Pressure	0.03~1.0MPa	0.03~1.0MPa	0.03~1.0MPa

LOCK AND UNLOCK METHOD

DOOR LOCK

When the machine is working, the door locks automatically. It can't be opened.

UNLOCK

When the machine is working, the user press the “START/PAUSE” button, the door can be unlocked after inner tub stopping spin.

- If take down the power plug directly or power cut when the machine is running, the door can't be unlocked automatically.
- If open the door when the machine is working, the froth may exceed and please clean it with towel.
- The user can't open the door when the machine is running with a high working temperature.
- The user can't open the door when the water temperature is high.

INTRODUCTION TO EACH COMPARTMENT OF DETERGENT BOX

Powder synthetic detergents



- For the undissolved detergents, for example: powder state soap, dissolve it in advance, then pour into the case.

Liquid detergent and bleach



- Use low bubble liquid synthetic detergents.
- For the concentrated liquid detergents, diluted it double times with water, then pour into the case.

Softener



- Put into the same before washing, it will be poured into tub automatically at the last round of rinse.
- For the concentrated detergents, use corresponding proportion of water to dilute it, then pour it into the case.
- No exceed to the full mark line.

Liquid detergents



- Liquid detergents can be poured in this case to ensure the wash performance.

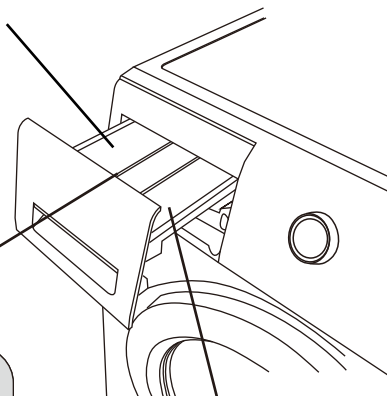

- High bubble washer powder or detergents is forbidden.
- Use the detergents in accordance with the instruction by its manufacturer.
- Excessive detergents will cause too much bubble and affect the rinse, also create function faults.
- Choose suitable detergents in accordance with the type and color of clothes, the water temperature and the stain.

INTRODUCTION TO THE CONTROL PANEL

The distribution

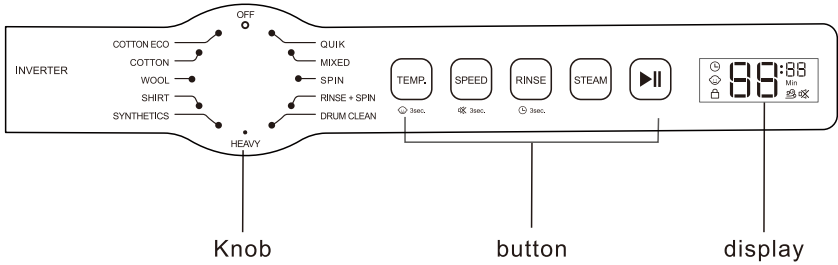

■ Program Knob

Turn the program knob to switch on the machine and select your desired wash program. The light will light up to indicate the selected program.

■ Stand-by position

Turn the knob to the stand-by position to switch the machine to stand-by (it switches to stand-by automatically at the end of the program, but the dial remains on the selected program position).

■ Display window

The display shows the settings, estimated remaining time, options, and status messages. When the appliance is turned on, the default settings in the display will illuminate.

88:88: When a program is selected, the default time for that program is displayed. The default time can be changed according to the selected option.

MIN: When set the wash/spin/soak and free wash time, and during program running, this icon is illuminated.

🔒: After set child lock function, this icon is illuminated.

🔒: When this icon is illuminated, the door cannot be opened.

🌀: When the icon is illuminated, the Steam function is under running (Only for the program which available for the Steam).

🕒: After set Delay function, this icon is illuminated.

INTRODUCTION TO THE CONTROL PANEL

■ TEMP. button

Press to adjust a program's default temperature .

■ SPEED button

Press to adjust a program's default spin speed .

■ RINSE button

Press to adjust the rinse times.

■ STEAM button(Only for the model which available for the STEAM function)

Press this button, to add the Steam function in the COTTON, SHIRT, QUICK WASH, MIXED program.

■ Start/PAUSE



This “**START/PAUSE**” button is used to start the wash cycle or pause the wash cycle. If a temporary stop of the wash cycle is needed, press the “**START/PAUSE**” button.

PROGRAM INTRODUCTION

COTTON ECO	A warm water eco program with an extra long washing time used for energy efficiency testing
COTTON	Normally soiled cottons, linens or cotton mix fabrics (e.g. table linen, towelling, underwear, T-shirts etc.)
MIXED	A warm water program for a mixed load of synthetic and cotton textiles
WOOL	A specially gentle program for machine-washable wool or wool-blend textiles. Designed to prevent shrinkage
SYNTHETICS	A gentle program for synthetic or synthetic blend textiles
QUICK	An extra short program for a few lightly soiled items
SHIRT	Cotton or mixed fibre shirts and blouses
RINSE+SPIN	Separate rinse program with spin
SPIN	Separate spin program with selectable speed. Drains water before spinning.
DRUM CLEAN	A drum cleaning program designed for use without laundry items
HEAVY	This program is specially designed for washing HEAVY

PROGRAM INTRODUCTION

Program	Max. Load (kg)	Default Temperature (default + temp. range) (°C)	Default Time (hr:min)	Rinse (times) (default+extra)
COTTON ECO*	Rated capacity	60 (cold-20-30-40-60-90)	1:47	2(0-6)
COTTON	Rated capacity	30 (cold-20-30-40-60-90)	1:07	2(0-6)
MIXED	≤6 (8.5kg) ≤6.5 (9.5kg) ≤7kg (10.5kg)	30 (cold-20-30-40-60)	1:02	2(0-6)
WOOL	≤2kg	cold (cold-20-30-40)	1:04	2(0-6)
SYNTHETICS	≤6kg	30 (cold-20-30-40)	1:07	2(0-6)
QUICK	≤1kg	cold (cold-20-30)	0:15	1(0-4)
SHIRT	≤3kg	30 (cold-20-30-40-60)	1:05	2(0-6)
RINSE+SPIN	Rated capacity	–	0:20	1(0-6)
SPIN	–	–	0:11	–
DRUM CLEAN	–	90	2:18	1
HEAVY	≤5kg	30 (cold-20-30-40-60)	1:17	2(0-6)

*This program is used for water efficiency test and its entering method is turning on the knob, selecting Cotton Eco program, selecting temperature to 60°C, then pressing Start/Pause button.

PROGRAM INTRODUCTION

Spin Speed (RPM) (default + extra) (8.5kg)	Spin Speed (RPM) (default + extra) (9.5/10.5kg)	Program
800rpm (400-600-800-1000-1200)	800rpm (400-600-800-1000-1200-1400)	COTTON ECO
1000rpm (400-600-800-1000-1200)	1000rpm (400-600-800-1000-1200-1400)	COTTON
1000rpm (400-600-800-1000-1200)	1000rpm (400-600-800-1000-1200)	MIXED
600rpm (400-600-800)	600rpm (400-600-800)	WOOL
800rpm (400-600-800-1000)	800rpm (400-600-800-1000)	SYNTHETICS
800rpm (400-600-800-1000)	800rpm (400-600-800-1000)	QUICK
800rpm (400-600-800-1000)	800rpm (400-600-800-1000)	SHIRT
1000rpm (400-600-800-1000-1200)	1000rpm (400-600-800-1000-1200-1400)	RINSE+SPIN
1000rpm (400-600-800-1000-1200)	1000rpm (400-600-800-1000-1200-1400)	SPIN
800rpm	800rpm	DRUM CLEAN
1000rpm (400-600-800-1000-1200)	1000rpm (400-600-800-1000-1200)	HEAVY

PROGRAM INTRODUCTION

User instruction for the normal clothes

Method

1. Preparation
 - Put the clothes in and close the door.
 - Put the detergent or washing powder into the detergent box.
 - Switch on the water tap, put the drain-pipe, plug the power supply.
2. Turn on the power.
3. Choose the suitable program.
4. Choose the suitable button.
5. Press the “START/PAUSE” button.
6. When finishing washing, the buzzer will sound.

Instruction to wool program

Method

- Turn on the power and choose the wool program.

Attention

- Please confirm the washing mark on the clothes before washing.
- When finishing wash, please take the clothes out immediately for airing in order to avoid clothes deformation.
- The temperature can't be setting more than 40 degree to avoid clothes damage.
- Using the wool detergent can improve the washing performance.
- Wash light colour clothes and dark colour clothes separately.

EXTRA OPTIONS AND FUNCTIONS

Introduction to Delay wash



Method

- Turn on the power and choose the suitable program and buttons according to user's requirement.
Press the RINSE button 3 seconds to setting the finishing time.
Press the start/stop button to start-up the delay wash function.
(Delay time has every one hour interval and maximum is 24hours.)

Attention

If need to change the delay wash , please press power button and set again.
After reservation, user can cancel it if press power button.
When confirm the delay wash, please press the delay button. The setting time will display for 5 seconds.
Delay wash time is different in different conditions. It depends on water pressure, drain, clothes type, water temperature.

Cancel the buzzer



Set/Cancel method

Turn on the power and press “SPEED” button for 3 seconds. When release the button, “Cancel the buzzer” function is finished setting. If repeat this action, the setting will be cancelled.

Child Protection Function

If the door is opened again before program running, the machine will start the child protection function automatically when working.
Firstly, the door will be opened and motor will be running for a while.
And then, the door will be unlocked for a while till working again. If during the waiting time, the door is opened, the machine will be stopped.

STEAM FUCTION (Only for the model which available for the STEAM function)

If the steam wash function is chosen, in the whole program, after 1st cycle wash process, all the water drain out. Then entering the Steam Wash function

The heating tube heats a small amount of water to produce steam, which fumigates the clothing. All the steam process will last 30mins.

In the Steam Wash function process, the spin tub will continue rotate, to achieve better effective.

After that, will continue the Rinse process.

Child Lock Function



User can set child lock function in order to avoid child operating the machine when it is working.
So the door can't be opened and the buttons (except power button) can't be handled. When cancel this function, door can be opened again.

Set/Cancel method

Turn on the power and press “TEMP.” button for 3 seconds till the buzzer sound. The child lock function is finished to set. If repeat this action, the child lock function will be cancelled.

CLEAN AND MAINTENANCE

- Please maintain the machine after long time using. It can extend the service life.
- Please take off the power supply when maintenance.

MACHINE BODY

- Please use soft cloth to clean the body after washing every time. If there is much dirty, please put some detergent or soap water on the cloth to clean the body.
- Please don't use water to flush the machine directly.
- Dirty powder, diluent, petrol and alcohol are forbidden to use to wash the machine.

DOOR GASKET

Please use cloth to clean the gasket after washing every time. If there are brooch or other sundries, please make sure to take them out.

DETERGENT BOX CLEAN

Please clean the detergent box regularly. Take out the box and clean it with water.

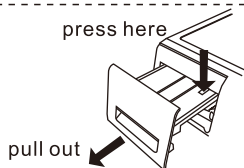

WATER INLET VALVE CLEAN (ONE TIME PER HALF OF YEAR SUGGESTION)

1. Take out the inlet pipe
2. Take out the filter screen
3. Use the toothbrush to clean the filter screen and then assemble it again
4. Connect the inlet pipe after cleaning.



DRUM CLEAN (ONE TIME MONTHLY SUGGESTION)

There may be dirty rest in the drum after long time using. The drum clean function can clean the inner and external drum. (Attention: please don't put in clothes and detergent when using drum clean function.)

CLEAN AND MAINTENANCE

Machine frozen

1. Using hot towel to envelop the water tap and connector.
 2. Disassemble the inlet pipe and put it into 50 degree hot water.
 3. Put 2-3liter 50 degree hot water into tub.
 4. Assemble the inlet pipe again, open the water tap and start the machine.
- At last, please examine whether the inlet pipe and drain pipe can work normally.

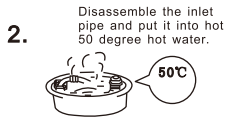
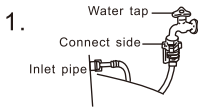

CLEAN FILTER OF PUMP (ONE TIME MONTHLY SUGGESTION)

1. Press the groove of pump.
The cover of filter can be opened.
(Attention: If there is hot water in the machine, please wait for cooling and then open the filter.)
2. Take out the filter anticlockwise.
3. Wash the filter with water.
4. Assemble the filter into the pump clockwise.

Attention: 1. The filter should be assembled tightly in order to avoid water leakage.
2. Please don't clean the filter when the machine is working.

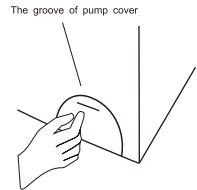

NON-FAILURE CONDITION

Condition	Reason
Door can't be opened	<ul style="list-style-type: none"> ● Water temperature is too high or power cut. ● Setting child lock function. ● The clothes is clamped between door and gasket.
Peculiar smell	<ul style="list-style-type: none"> ● Because using rubber components, it has rubber smell at the beginning.
Less water for washing and rinsing wash	<ul style="list-style-type: none"> ● Front load washer consumes less water
No water	<ul style="list-style-type: none"> ● If the tap is turning on or not ● If the water pipe is frozen or not ● If the filter is blockage or not
Halfway inflow the water	<ul style="list-style-type: none"> ● If the water level drop, the system will automatically filling water
Drainage when the machine is washing	<ul style="list-style-type: none"> ● too much bubbly detergent
Residual time change	<ul style="list-style-type: none"> ● washing machine will automatically filling water to keep balance, if the clothes are misdistributed . ● The rest time is calculated based on 15L/min inflow. So according to different water pressure, time will be extended or shorten. ● washing machine will extend spinning time, if the clothes appear tilt.
During spinning abnormal sound	<ul style="list-style-type: none"> ● Is power line connected to cabinet? ● Is the carriage bolts have been removed? ● Is there a hairpin, coins or other foreign objects fall into drum?
Failure to work after power failure	<ul style="list-style-type: none"> ● When power cut off, the machine will not revolve. If recover the power, machine still not revolve, please press "power turn on/off" then reset program.
Emergency open door	<ul style="list-style-type: none"> ● When the power failure for a long time and you want to take out the clothes, unplug the power cord, waiting for the inner drum stop, pull down the emergency rope on the bottom right corner of cabinet, listening a slight noise then you can open the door. (Confirm the water level below the bucket and water temperature below 60°C in advance.)

TROUBLESHOOTING GUIDE

Fault code	phenomenon	inspection point	solution
No display	out of operation	<ul style="list-style-type: none"> ● whether the outlet have electricity ● whether the outlet is plugged in power cut or not ● leakage protector switch off or not ● set up booking function or not 	
E11	No water	<ul style="list-style-type: none"> ● Tap turn on/off? ● Ensure the water pipe has been frozen or not ● Ensure the filter has been blockage or not ● water stopped or not 	Press the “START/PAUSE” button
E12	undrained	<ul style="list-style-type: none"> ● ensure the drain pipe in the right place ● drain height too high or not ● ensure the drain-pipe has been blockage or not ● ensure the drain-pipe length 	Press the “START/PAUSE” button
H	Door can't be opened	<ul style="list-style-type: none"> ● make sure don't use hot water ● the water temperature is high when washing ● Suspension of drying 	automatic unlocking Until the temperature drops to safety level
U3	No dehydration	<ul style="list-style-type: none"> ● ensure the washer in the right place and steady ● make sure don't have too much clothes and too big clothes Button,when there have fewer clothes. ● fewer dehydrated clothes ● don't rolled up the blanket into the machine. 	add 2 pieces of cloth and Press the “START/PAUSE” button
U4	Door not closed		close the door, until the “locked” light on, confirm it then press “START/PAUSE” button to reoperation
Other code	Alarm		Press “START/PAUSE” button to reoperation, If still can't solve the problem, please contact the service center.

SHARP

SHARP CORPORATION
OSAKA, JAPAN