

SHARP®

VACUUM CLEANER OPERATION MANUAL

Thank you very much for buying SHARP.
Before using your SHARP vacuum cleaner, please read this operation manual
carefully to obtain the best use from your vacuum cleaner.

EC-LS18
EC-LS20

คู่มือการใช้งาน เครื่องดูดฝุ่น

ขอขอบพระคุณที่ท่านเลือกซื้อผลิตภัณฑ์จากชาร์ป
ก่อนเริ่มการใช้งานเครื่องดูดฝุ่นของชาร์ป โปรดอ่านคู่มือการใช้งานอย่างละเอียด
เพื่อให้ได้รับประโยชน์อย่างสูงสุดจากการใช้งานเครื่องดูดฝุ่นนี้

MANUEL D'UTILISATION DE L'ASPIRATEUR

Merci d'avoir acheté un produit SHARP.
Avant d'utiliser votre aspirateur SHARP, veuillez lire ce manuel d'utilisation
attentivement pour utiliser au mieux votre aspirateur.

MANUAL DE INSTRUÇÕES DO ASPIRADOR SHARP

Muito obrigado por comprar um produto SHARP.
Antes de utilizar o aspirador SHARP, leia este manual de instruções
atentamente para o utilizar nas melhores condições.



IMPORTANT USER INFORMATION

To reduce the risk of fire, electric shock or injury:

- 1 Electric shock could occur if used outdoors or on wet surfaces.
- 2 Do not leave unattended when plugged in, unplug from an outlet when not in use and before user-maintenance.
- 3 The Appliance is not to be used by persons (including Children) with reduced physical, sensory or mental capabilities, or lack of experience and knowledge, unless they have been given supervision or instruction
- 4 Use only for intended use as described in this manual. Use only the manufacturer's recommended accessories and dust bag.
- 5 Never operate this vacuum cleaner if it has a damaged cord or plug, if it is not working properly, if it has been dropped, damaged, exposed to weather or dropped into water. Return the vacuum cleaner to a Sharp Authorized Servicer for examination and repair.
- 6 Do not pull or carry this vacuum cleaner by the power cord. Do not use the power cord as a handle, close a door on the cord, or pull the cord around sharp edges or corners. Keep the cord away from heated surfaces.
Do not run this vacuum cleaner over the cord.
- 7 Never disconnect the plug by pulling the cord. To disconnect from an outlet, grasp the plug, not the cord.
- 8 Never operate this vacuum cleaner with any air opening blocked.
Keep the air openings free of dust, lint, hair or any other similar material. When HEPA filter becomes dirty, rinse in lukewarm water. The filter should be completely dry before reusing.
- 9 Never drop or insert any object into any opening.
- 10 Keep hair, face, fingers or loose clothing away from any opening, such as all moving parts.
- 11 Do not pick up lit cigarettes, hot ashes, matches or similar materials, razor blades, needles, pins or other sharp objects. Do not suck water or any other liquid.
- 12 Never operate this vacuum cleaner without the dust cup.
- 13 Before removing the plug from an outlet, press the switch to "OFF".
- 14 Use extra caution when cleaning on stairs.
- 15 Never handle the plug, cord or vacuum cleaner with wet hands.
- 16 Do not use in presence of flammable or combustible liquids or fumes.
- 17 Do not place heavy objects on the vacuum cleaner.
- 18 Do not step on the hose or pull the hose forcibly.
- 19 Do not pick up large objects such as wasted paper or cloth which may clog the hose.
- 20 Do not expose this vacuum cleaner to high temperature while operating or during storage.
- 21 Store the vacuum cleaner in a dry place.
- 22 Use the carrying handle of the body to carry the vacuum cleaner.
- 23 Rewind the cord by holding the plug to prevent any injury.

Caution: If the cord of this appliance is damaged, it must only be replaced by the repair shop appointed by SHARP in order to avoid hazard.

Product and Accessories

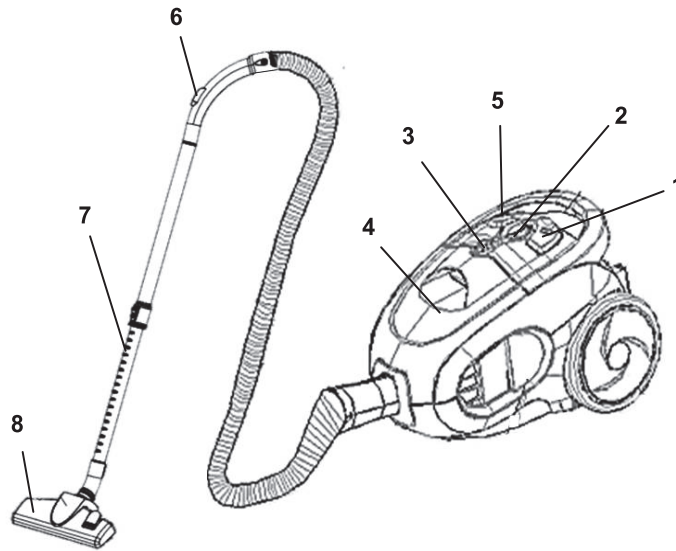

9

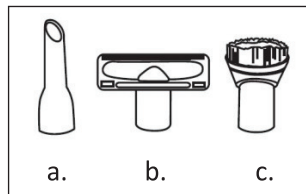

1. **ON / OFF SWITCH**
With the cord plugged into an electrical outlet, start or stop the vacuum cleaner by pressing the switch.
2. **POWER CONTROL**
A turning switch allows the selection of any cleaning power from "MIN (for draperies)" to "MAX (for floors)"
3. **DUST INDICATOR**
An indicator that will change to red colour when the dust cup is full.
4. **DUST CUP**
Transparent dust container. On spot control over the dust collected.
5. **CORD REWIND BUTTON**
To rewind the cord, press the cord rewind button while holding the plug. If the cord is not retracted completely, pull it out a little and press the cord rewind button again.
6. **AIR SLIDE VALVE**
Open the controller on the hose handle to control air or to release any items suck in the nozzle.
7. **METAL TELESCOPIC**
To extend or shorten the metal telescopic pipe, slide the button.
8. **FLOOR NOZZLE**
2-WAYS FLOOR NOZZLE
Ideal for the daily cleaning of carpets and hard floors.
9. **ACCESSORIES**
 - a. **Crevice tool**
Use for cleaning door tracks, narrow spots, etc.
 - b. **Small brush**
Use for cleaning a sofa.
 - c. **Dusting brush**
Use for cleaning a furniture, draperies, blinds, lamp shade, etc.

SAVE THESE INSTRUCTIONS

This vacuum cleaner is intended for household use only.

WARNING

Operate this vacuum cleaner only at the voltage specified on the name plate.

SPECIFICATIONS

MODEL	VOLTAGE(AC)	POWER CONSUMPTION(MAX)	DUST DISPOSAL SYSTEM
EC-LS18	220V-240V	1800W MAX	Bagless
EC-LS20		2000W MAX	

HOW TO DISPOSE DUST

- The vacuum cleaner is equipped with the dust indicator (change to red colour). When the dust indicator shows that the dust cup is full, you should dispose dust.
- If the dust cup is not full, but the indicator shows that it is full, the suction nozzle, hose, or extension pipe could be blocked. Then, unblock the obstacle.
- If the vacuum cleaner takes in excessive amount of fibre (thread, cottony material, etc.) the indicator may not change to red colour even if the dust cup is full.

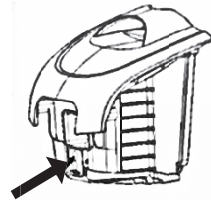

- To dispose dust, press the lock button.



- Empty the dust cup in the trash can
- Insert the dust cup back into the cleaner.

HOW TO REMOVE DUST FROM THE DUST CUP

Note Before removing the dust cup, make sure to take off the hose. Always operate the vacuum cleaner with the dust cup installed. To keep the suction power highly efficient and lengthen a life of motor, please dispose dust frequently.

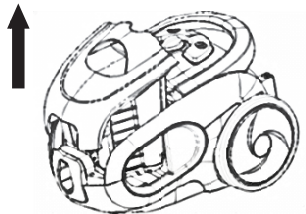

- Remove the dust cup as shown

MAINTENANCE

Unplug the vacuum cleaner from an electrical outlet before maintenance

CLEANING THE UNIT

When cleaning the unit, use a dampened cloth with lukewarm water. Never clean or spray with a liquid such as insecticide, benzene, thinner or oil.

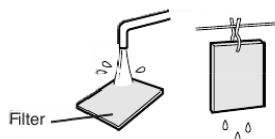

- Rinsed sponge in lukewarm water and dry the sponge thoroughly.
- Put the sponge and HEPA filter back.

CLEANING HEPA FOR AIR-INLET

Note:
The filter should be cleaned at times or when it becomes visibly soiled. Always operate the vacuum cleaner with filter installed. Otherwise, suction power may be decreased or the motor may be damaged.

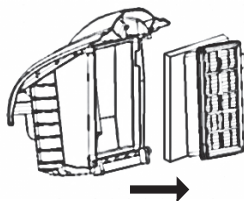

- Remove the HEPA from the dust cup
- Rinse the HEPA in lukewarm water and dry completely.
Do not use a washing machine to rinse the filter.
Do not use a hair dryer to dry it.

CLEANING THE OUTLET FILTER

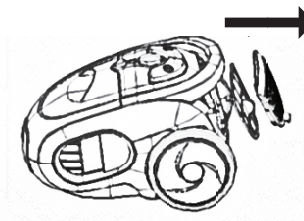

- Open the air-outlet cover and pull the filter out.
- Wash and dry the HEPA thoroughly.
- Put the filter back.

BEFORE ASKING FOR SERVICE

If you experience any difficulties with your vacuum cleaner, use this Troubleshooting Chart first before requesting service.

NOTE: Always remember to have the vacuum cleaner turned OFF and disconnect the plug from an electrical outlet before working on the vacuum cleaner.

TROUBLESHOOTING CHART

Problem	Check	Countermeasure
The unit does not function or decrease in suction power.	Check to see if the dust cup is filled with dust.	Dispose dust.
	Check to see if the suction hose, extension pipes or floor nozzle is clogged.	Remove any foreign object that may have become jammed in the floor nozzle, hose or pipe.
The motor does not rotate.	Make sure the vacuum cleaner is plugged in and that outlet is working.	Make sure to plug into an outlet. Plug into another outlet.
The cord is not rewind.	Is the cord entangled?	Pull the cord out a little and press the cord rewind button again.

WARNING

This vacuum cleaner contains a motor protection system to maximize the motor life. It is designed to shut off to avoid overheating in case of a blockage or clogged filter. If the protection device is activated, the vacuum cleaner stops without turning off the switch. If this happens, turn off and unplug the vacuum cleaner.

Please empty the dust bag and clean the motor pre-filter.

After approximately 1 hour, the motor will have cooled and the vacuum cleaner will be ready to use.

Operating this vacuum cleaner with clogged or dirty filter may cause the vacuum cleaner to overheat.

Please clean the motor pre-filter and empty the dust bag regularly.

Please request service if the problem still persists or if the problem is not defined in the Troubleshooting Chart.