



SHARP®

AQUOS

androidtv

LED BACKLIGHT TV

OPERATION MANUAL

- Please choose your favourite page from the content.
If you want to close the operation manual, press the **EXIT** button.
Also, if you want to return to the previously displayed page, press the **← (Back)** button.

 DOLBY AUDIO™

 HDMI™
HIGH-DEFINITION MULTIMEDIA INTERFACE

 WiFi®
CERTIFIED

 Wi-Fi PROTECTED
SETUP

 Bluetooth®

 eilex
PRISM

 VIR
FILTER

ENGLISH | FRANÇAIS | PORTUGUÊS | РУССКИЙ | 中文 | INDONESIA | ภาษาไทย | TIẾNG VIỆT | عربي | АҒЫЛШЫН | O'ZBEK TILIDA

1. Part Names

- 1-1. TV
- 1-7. Remote Control Unit

2. How to select the TV Mode

- 2-1. Using the Remote Control Unit
- 2-2. HOME screen
- 2-4. Settings
- 2-5. Chromecast built-in compatible devices
- 2-6. Tools

3. Tool Operation

- 3-1. Introduction
- 3-2. View Setting
- 3-3. Picture
- 3-22. Audio

4. Settings

- 4-1. TV
- 4-23. Personal
- 4-29. Network & Peripherals

5. Direct Button Operation

- 5-1. Changing Channels
- 5-2. Changing Volume
- 5-3. MUTE
- 5-4. FLASHBACK
- 5-5. AUDIO AD
- 5-6. Sleep Timer
- 5-7. VIEW MODE
- 5-10. NETFLIX
- 5-11. YouTube™

6. Enjoying Photo/Music/Video Playback

- 6-1. Preparation
- 6-3. Selecting the Folders to Play Back
- 6-6. Playing Back Files on a USB Memory Device/Home Network Server
- 6-15. Playing Back Files from a Portable Device

7. Using LINK Operation

- 7-1. Controlling HDMI Equipment Using LINK Operation

8. Using a PC

- 8-1. Setting Audio Input

9. Using the Internet

- 9-1. Connecting to the Internet
- 9-3. Using Keyboard and Mouse
- 9-4. Notes

10. Appendix

- 10-1. Troubleshooting
- 10-3. Troubleshooting - Error Message
- 10-4. Information on the Software License for This Product

11. Trademarks**12. Specifications**

- 12-1. TV
- 12-2. Wireless LAN

13. Dimensional Drawings

- 13-1. 4T-C50AL1X / 4T-C50AL2X
- 13-2. 4T-C60AL1X
- 13-3. 4T-C70AL1X

Precautions For Daily Use

Observe the following items

Maintenance of the cabinet

- When cleaning the cabinet, use a soft cloth (made of cotton, floss, etc.) to clean gently.
- Do not use a dry or damp rag mixed with chemicals, as this could cause the ingredients of the cabinet body to deteriorate or crack.
- Be careful not to use an abrasive cloth for cleaning or clean with excessive force, as this could scratch the surface of the cabinet.
- If the cabinet is greatly soiled, clean with a soft cloth (made of cotton, floss, etc.) soaked with a small amount of diluted neutral detergent and wrung out, and then clean with a soft dry cloth.
- Solvents such as benzene or thinner could cause the cabinet to deteriorate, or make its coating come off. Therefore do not use such solvents to clean the cabinet.
- Because plasticizer is included in the plastics, deterioration or the coating peeling off could occur when the cabinet comes into contact with some substances. Therefore keep it away from volatile substances such as insecticide. In addition, do not let it come into contact with objects made of rubber, resin, etc. for a long time.

Maintenance of the LCD panel

- Before cleaning the LCD panel, be sure to turn off the TV set and unplug the power cord from the outlet.
- When cleaning the LCD panel, use a dry and soft cloth (made of cotton, floss, etc.) to clean the surface of the LCD panel gently. For protecting the LCD panel, do not clean with a dirty cloth, detergent, or a dry or damp rag mixed with chemicals, as this could cause peeling of the panel surface.
- Be careful not to clean with an abrasive cloth or with excessive force, as this could cause the panel surface to be scratched.
- If the LCD panel is greatly soiled, clean it gently with a soft cloth (made of cotton, floss, etc.) soaked with a small amount of water (Do not clean with excessive force, so as to avoid the scratch of the panel surface).
- If dust sticks on the surface of the LCD panel, clean the panel with a commercially available cleaning brush (anti-static brush).

Important safety precautions

Caring for the cabinet

- Use a soft cloth (cotton, flannel, etc.) and gently wipe the surface of the cabinet.
- Using a chemical cloth (wet/dry sheet type cloth, etc.) may deform the components of the main unit cabinet or cause cracking.
- Wiping with a hard cloth or using strong force may scratch the surface of the cabinet.
- If the cabinet is very dirty, wipe with a soft cloth (cotton, flannel, etc.) soaked in neutral detergent diluted with water and thoroughly wrung out, and then wipe with a soft dry cloth.
- The cabinet is primarily made of plastic. Avoid using benzene, thinner, and other solvents, as these may deform the cabinet and cause the paint to peel off.
- Do not apply insecticides or other volatile liquids.
- Also, do not allow the cabinet to remain in contact with rubber or vinyl products for a long period of time. Plasticizers inside the plastic may cause the cabinet to deform and cause the paint to peel off.
- When relocating the product placed on a cart, it must be moved with utmost care. Sudden stops, excessive force and uneven floor surface can cause the product to fall from the cart.



Caring for the front panel

- Turn off the main power and unplug the AC cord from the wall outlet before handling.
- Gently wipe the surface of the front panel with a soft cloth (cotton, flannel, etc.).
- To protect the front panel, do not use a dirty cloth, liquid cleaners, or a chemical cloth (wet/dry sheet type cloth, etc.). This may damage the surface of the front panel.
- Wiping with a hard cloth or using strong force may scratch the surface of the front panel.
- Use a soft damp cloth to gently wipe the front panel when it is really dirty (It may scratch the surface of the front panel when wiped strongly).
- If the front panel is dusty, use an anti-static brush, which is commercially available, to clean it.
- Water and moisture — Do not use the product near water, such as bathtub, washbasin, kitchen sink, laundry tub, swimming pool and in a wet basement.



Introduction

- Do not place vases or any other water-filled containers on this product. The water may spill onto the product causing fire or electric shock.



- Stand — Do not place the product on an unstable cart, stand, tripod or table. Doing so can cause the product to fall, resulting in serious personal injuries as well as damage to the product. Use only a cart, stand, tripod, bracket or table recommended by the manufacturer or sold with the product. When mounting the product on a wall, be sure to follow the manufacturer's instructions. Use only the mounting hardware recommended by the manufacturer.



- Ventilation — The vents and other openings in the cabinet are designed for ventilation. Do not cover or block these vents and openings since insufficient ventilation can cause overheating and/or shorten the life of the product. Do not place the product on a bed, sofa, rug or other similar surface, since they can block ventilation openings. This product is not designed for built-in installation; do not place the product in an enclosed place such as a bookcase or rack, unless proper ventilation is provided or the manufacturer's instructions are followed.



- In case the product is dropped and the cabinet is damaged, be sure to turn off the power of the product, and unplug the power cord. If you continue to use the product, it may cause fire or electric shock. Contact your dealer.



- Do not open the rear cover of the cabinet to reconstruct the circuits. There exists high voltage within the cabinet and it may cause electric shock and injury. If maintenance is required, contact your dealer.



- The LCD panel used in this product is made of glass. Therefore, it can break when the product is struck forcefully or with a sharp object. If the LCD panel is broken, be careful not to be injured by broken glass.



- Heat sources — Keep the product away from heat sources such as radiators, heaters, stoves and other heat-generating products (including amplifiers).



Do not install the TV in a location in which it will be subject to water drops such as underneath an air conditioning unit or in the vicinity of a humidifier

- Water drops falling onto the TV and water entering inside it may result in fire, electric shock, or malfunctions. We recommend that you install the TV at least 1 m away from the outlet of an air conditioner.



- To prevent fire, never place any type of candle or naked flames on the top or near the TV set.



- To prevent fire or shock hazard, do not place the AC power cord under the TV set or other heavy items.



- Do not place heavy objects on this product or stand on it. Doing so could cause injury if the product overturns. Take special care near children and pets.



- Unplug the power cord before you move the TV set. If not unplugged beforehand, the power cord may become damaged and cause electric shock.

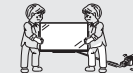

The LCD panel is a very high technology product with 8,294,400 pixels, giving you fine picture details. Due to the very large number of pixels, occasionally a few non-active pixels may appear on the screen as a fixed point of blue, green, red or yellow. This is within product specifications and does not constitute a fault.

Precautions when transporting the TV

- When transporting the TV, never carry it by holding or otherwise putting pressure onto the display. Be sure to always carry the TV by two or more people holding it with two hands — one hand on each side of the TV.



If a television is not positioned in a sufficiently stable location, it can be potentially hazardous due to falling. Many injuries, particularly to children, can be avoided by taking simple precautions such as:

- Using cabinets or stands recommended by the manufacturer of the television.
- Only using furniture that can safely support the television.
- Ensuring the television is not overhanging the edge of the supporting furniture.
- Not placing the television on tall furniture (for example, cupboards or bookcases) without anchoring both the furniture and the television to a suitable support.
- Not standing the televisions on cloth or other materials placed between the television and supporting furniture.
- Educating children about the dangers of climbing on furniture to reach the television or its controls.

- Do not display a still picture for a long time, as this could cause an afterimage to remain.

- Install the product on the place where the AC cord can be unplugged easily from the AC outlet, or from the AC INPUT terminal on the rear of the product.

NOTE

- The above are pictures for reference only; the actual item might be different.

TV

(Front)
4T-C50AL1X/4T-C50AL2X

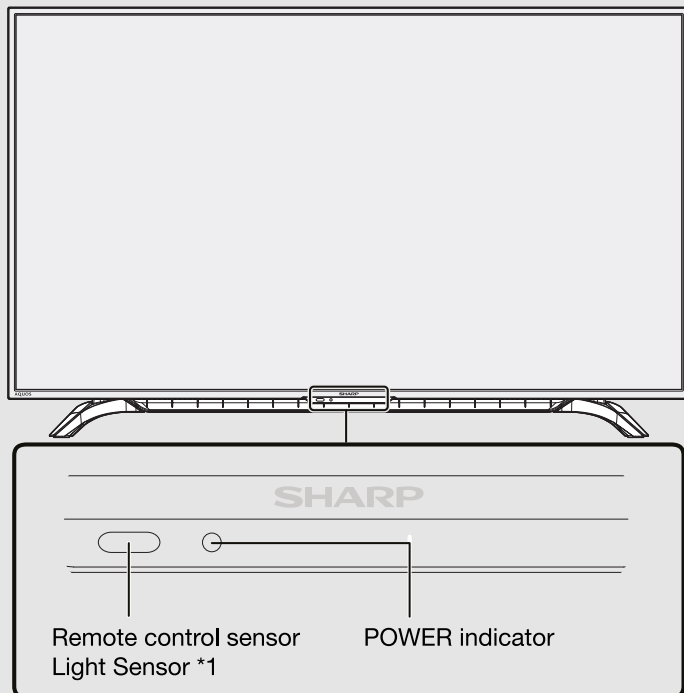

(Side)

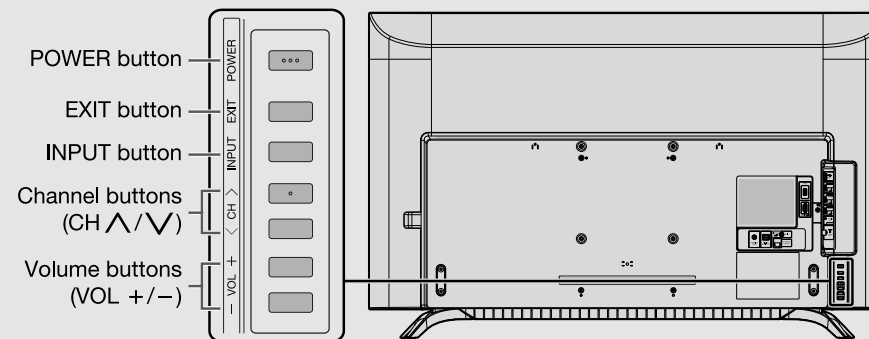

*1 [See page 3-4.](#)

- The illustrations and on-screen displays in this operation manual are for explanation purposes and may vary slightly from the actual operations.
- The drawings used throughout this manual are based on the 4T-C50AL1X/4T-C50AL2X model.

TV (Continue)

(Front)
4T-C60AL1X

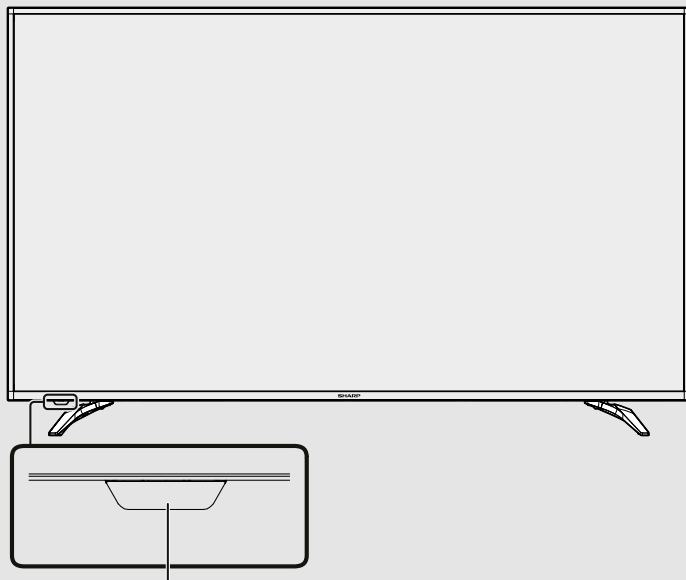

Remote control sensor/POWER indicator

(Side)

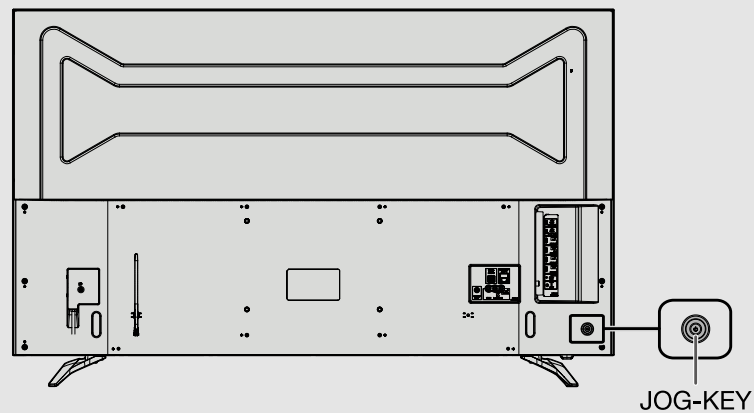

JOG-KEY	Functions Descriptions
PRESS	POWER button
UP	CH UP button
DOWN	INPUT button
LEFT	VOL + button
RIGHT	VOL - button

- The illustrations and on-screen displays in this operation manual are for explanation purposes and may vary slightly from the actual operations.
- The drawings used throughout this manual are based on the 4T-C50AL1X/4T-C50AL2X model.

TV (Continue)

(Front)
4T-C70AL1X

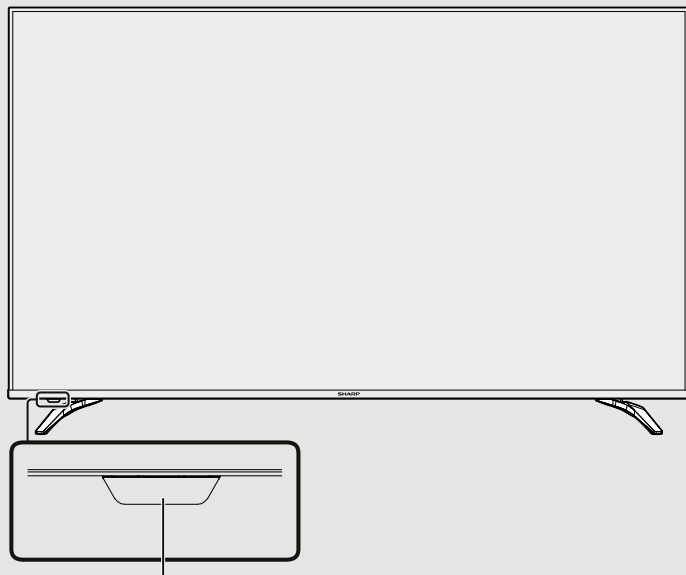

Remote control sensor/POWER indicator

(Side)

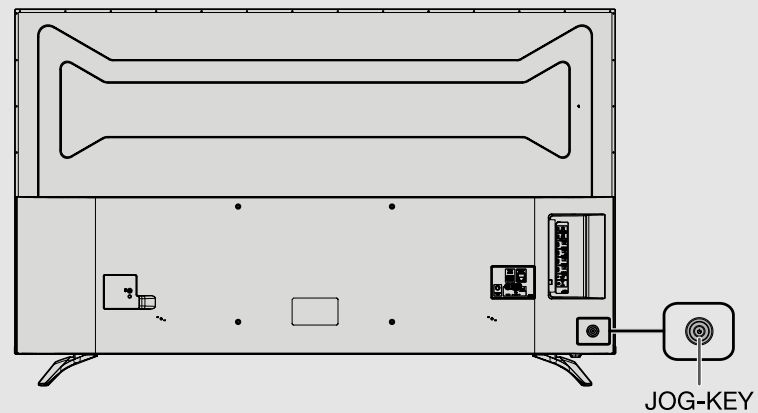

JOG-KEY

JOG-KEY	Functions Descriptions
PRESS	POWER button
UP	CH UP button
DOWN	INPUT button
LEFT	VOL + button
RIGHT	VOL - button

- The illustrations and on-screen displays in this operation manual are for explanation purposes and may vary slightly from the actual operations.
- The drawings used throughout this manual are based on the 4T-C50AL1X/4T-C50AL2X model.

TV (Continue)

(Rear)
4T-C50AL1X/4T-C50AL2X

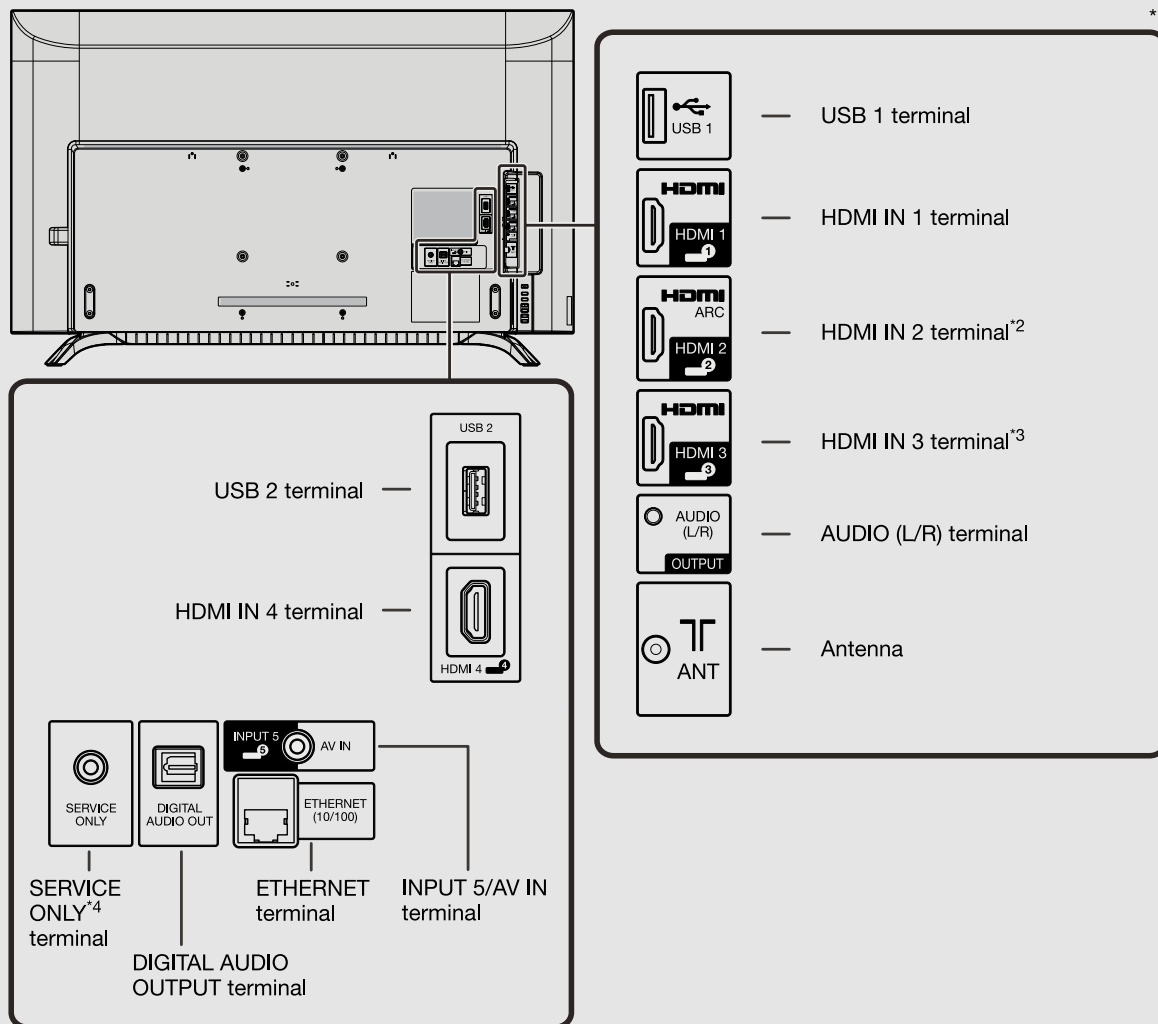

- HDMI IN 1 and 2 terminals are all capable of receiving 4K60P 4:4:4 signals. To receive 4K60P 4:4:4 signals, on the Devices menu, set the HDMI type to "Full". ([See page 4-9](#))

- ^{*1} See the Setup Guide. And [see page 7-1](#) for external equipment connection.
- ^{*2} Use HDMI IN 2 to connect ARC-compatible equipment.
- ^{*3} [See page 8-1](#) for details on the Audio Select function.
- ^{*4} Usually do not connect anything to this terminal as it reserved only for service personnel.

TV (Continue)

(Rear)
4T-C60AL1X

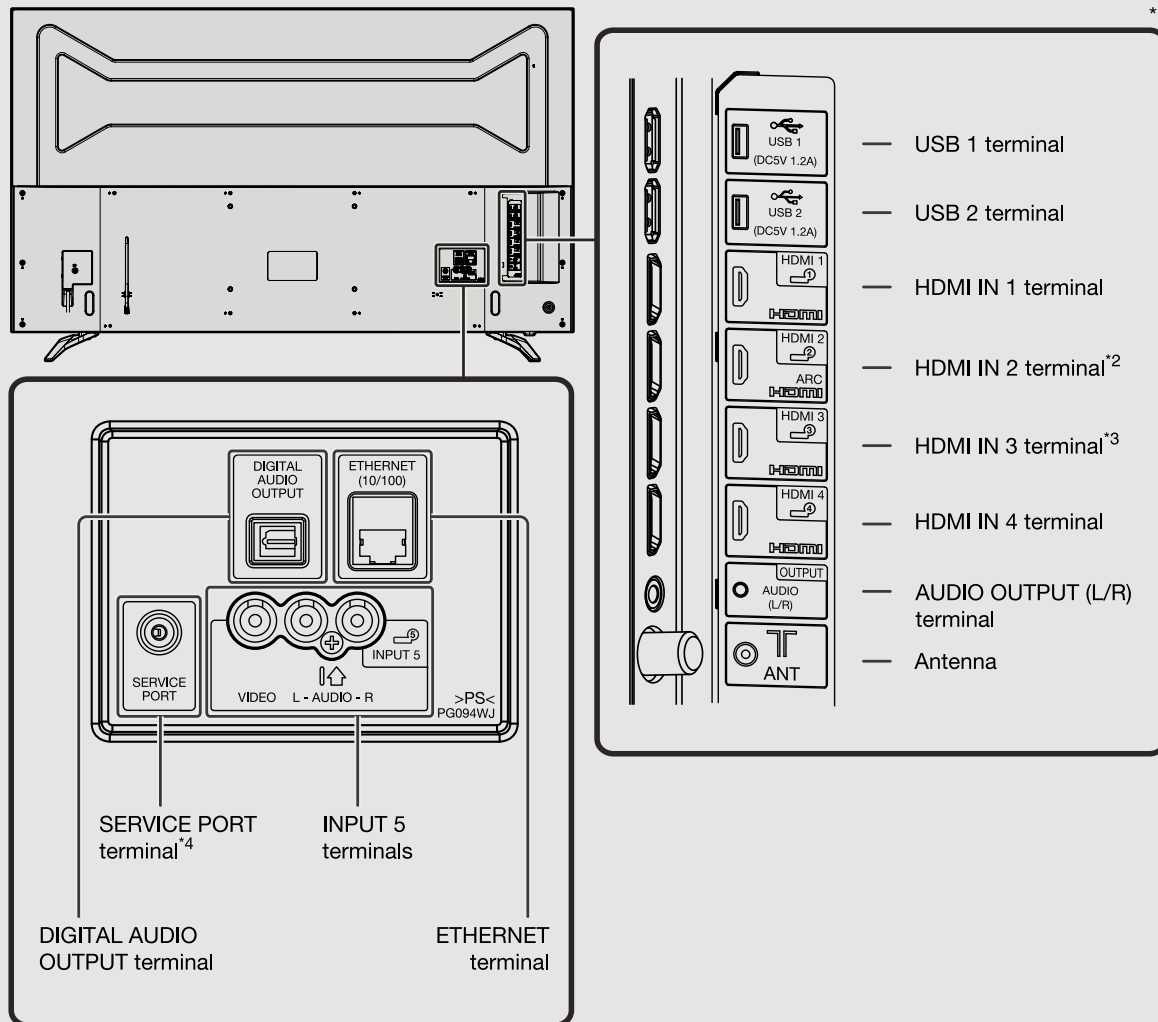

- HDMI IN 1 and 2 terminals are all capable of receiving 4K60P 4:4:4 signals. To receive 4K60P 4:4:4 signals, on the Devices menu, set the HDMI type to "Full". ([See page 4-9](#))

- *1 See the Setup Guide. And [see page 7-1](#) for external equipment connection.
- *2 Use HDMI IN 2 to connect ARC-compatible equipment.
- *3 [See page 8-1](#) for details on the Audio Select function.
- *4 Usually do not connect anything to this terminal as it reserved only for service personnel.

TV (Continue)

(Rear)
4T-C70AL1X

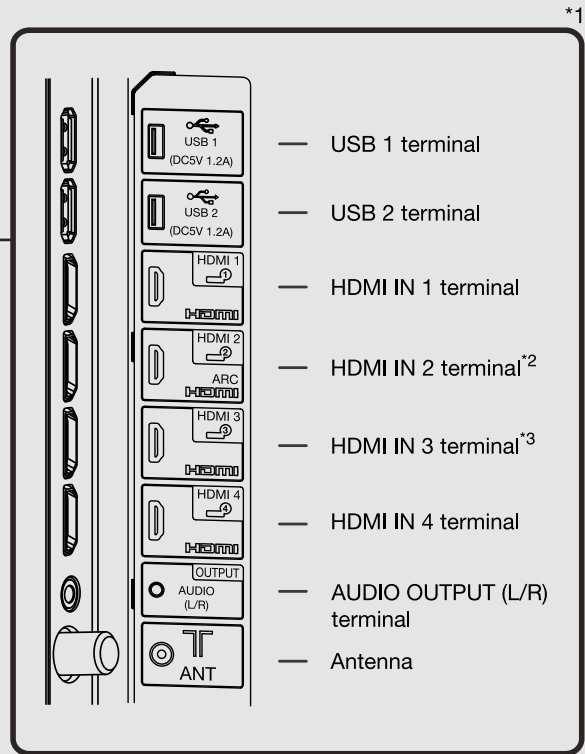
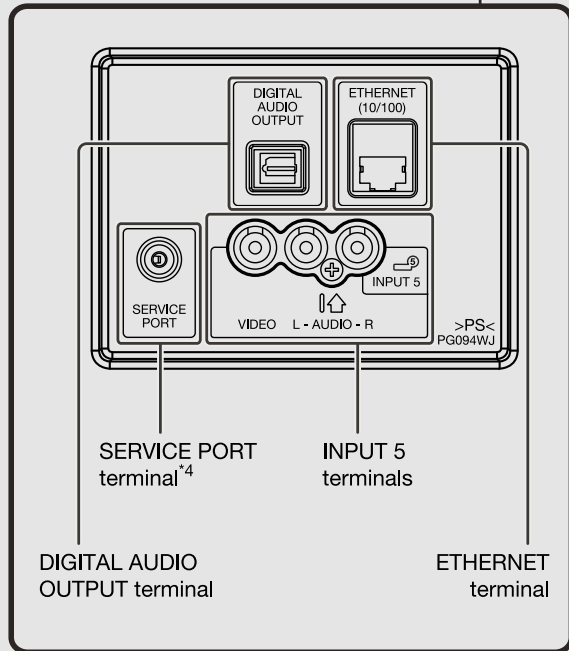
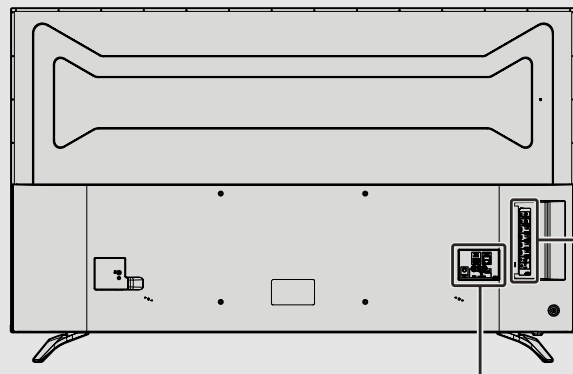

- HDMI IN 1 and 2 terminals are all capable of receiving 4K60P 4:4:4 signals. To receive 4K60P 4:4:4 signals, on the Devices menu, set the HDMI type to "Full". ([See page 4-9](#))

- *1 See the Setup Guide. And [see page 7-1](#) for external equipment connection.
- *2 Use HDMI IN 2 to connect ARC-compatible equipment.
- *3 [See page 8-1](#) for details on the Audio Select function.
- *4 Usually do not connect anything to this terminal as it reserved only for service personnel.

Remote Control Unit



1 POWER: Switch the TV power on or enter standby.

2 Buttons for useful operations

(Reveal hidden teletext)
Display hidden characters.

(Hold)
Stop updating teletext pages automatically or release the hold mode.

(Top/Bottom/Full)
Set the area of magnification.

(Subpage)
Display the teletext subpage directly.

(Teletext)
Select the teletext mode.

(Subtitle)
Switch subtitle languages on / off.

3 0-9: Set the channel. [\(See page 5-1.\)](#)

4 (FLASHBACK): Return to the previous channels, HDMI IN 1 through 4, or video input mode. [\(See page 5-4.\)](#)

5 OPC: To switch the optical picture control on and off. [\(See page 3-4.\)](#)

6 VOL+/-: Set the volume. [\(See page 5-2.\)](#)

7 MUTE: Mute the sound. [\(See page 5-3.\)](#)

8 SLEEP: Set the sleep timer. [\(See page 5-6.\)](#)

9 AUDIO AD: Selects the audio mode during multichannel audio broadcasts. [\(See page 5-5.\)](#)

10 External equipment operational buttons: Operate the external equipment.

Remote Control Unit (Continue)



11 R, G, Y, B: The coloured buttons are correspondingly used to select the coloured items on the screen.

12 AV MODE: Select an audio or video setting. ([See page 3-3.](#))

13 VIEW: Select the screen size. ([See pages 5-7 to 5-9.](#))

14  **(Back):** Return to the previous screen.

15  **(ENTER):** Select a desired item on the screen.

16 EXIT: Turn off the menu screen and application.

17 Voice: Start a Voice Search.

Speak the word that you want to search for into the microphone at the bottom of the remote control. When you are using the microphone, do not cover this part with your hand.

18 NETFLIX: Display the NETFLIX screen.

If you press the NETFLIX button when the TV is turned off, the TV turns on and the NETFLIX screen is displayed. ([See page 5-10.](#))

Remote Control Unit (Continue)



19 POWER (DEVICES):

Switch the devices power on or enter standby.

20 TV: Press to access analogue and digital TV mode.

21 INPUT: Select an input source.

22 CH ^ / V: Select the channel. [\(See page 5-1.\)](#)

23 EPG: DTV: Display the EPG screen.

24 DISPLAY: Display the channel information.

25 INFO

DTV: Display the programme information.

26 SURROUND: Select surround setting.

27  (HOME): Display the HOME screen. [\(See pages 2-1 and 2-2 to 2-3.\)](#)

28 TOOL: Display the Tool screen. [\(See page 2-6.\)](#)

29 e-manual: Display the operation manual.

30 YouTube: Display the YouTube screen.

31 Microphone: Used in Voice searches and apps. When you are using the Microphone, do not cover this part with your hand.

Using the Remote Control Unit

The main TV modes can be displayed by pressing the **TOOL** button on the remote control unit.

HOME screen

Press  (**HOME**) to display the HOME screen.



Example

Tools

Press **TOOL** to display the Tools screen.

[See pages 2-6](#) and [3-1 to 3-33](#) for details of Tools.



HOME screen

To display the HOME screen, press the  (**HOME**) button on the remote control unit.

Example

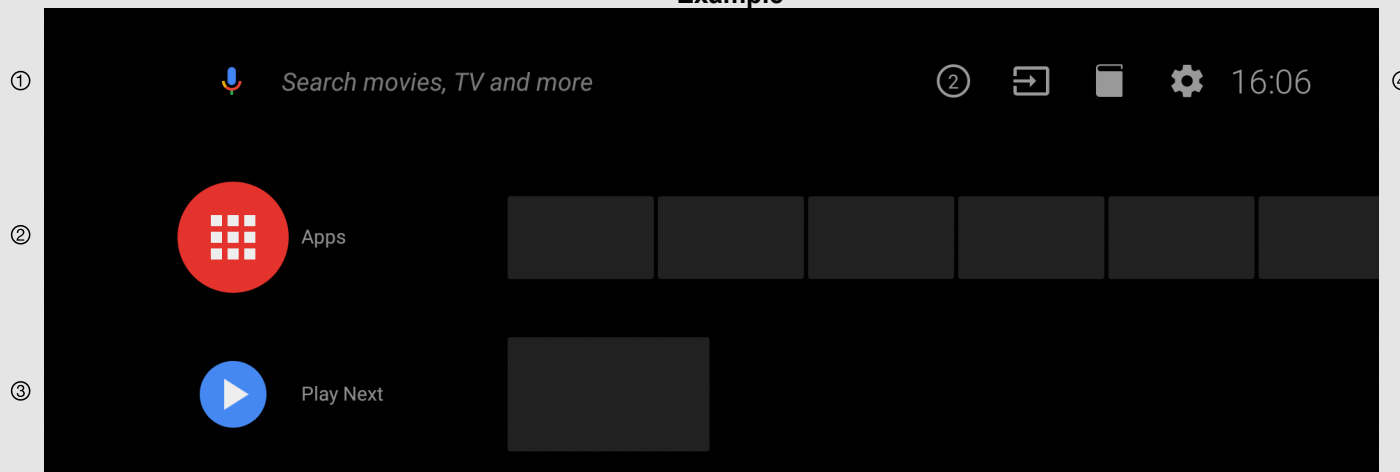

① Start a Search.

② Among the applications installed on the TV, the icons for the favourite applications are shown inside here. (Favourite applications can be added / deleted / changed its order by users.)

 **Apps** : Click to jump to Apps screen where all the installed applications are listed.

③ The contents of the programmes that user is watching or watched are displays here.

④

 **Notification**: Display the notifications.

 **Inputs**: Icon to select an input source.

 **E-Manual**: Icon for the built-in operation manual.

 **Settings**: Various settings can be configured here.
For details on the settings, see the next explanation.

NOTE

- When you are using the microphone, [see page 1-5](#).

HOME screen (Continue)

Example

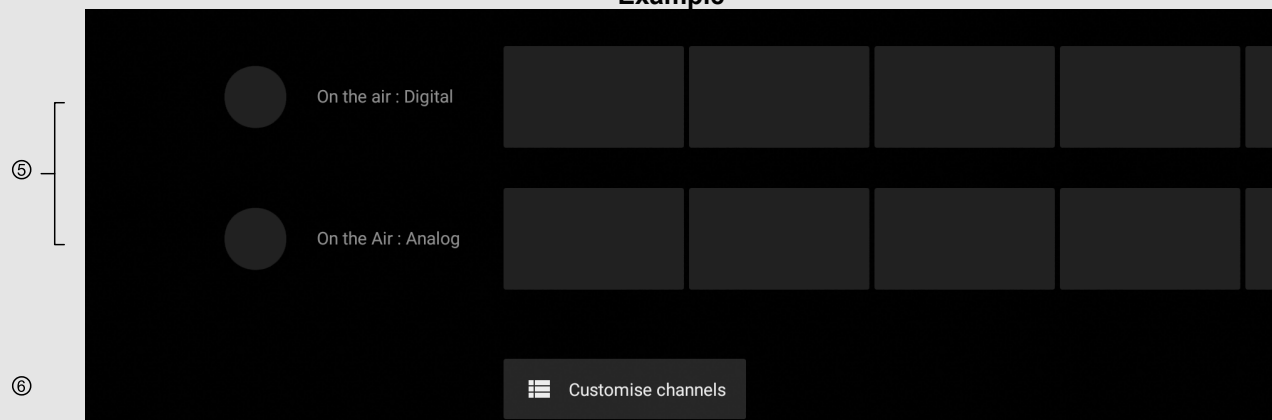

⑤ Channels served by install applications are displayed here. Channels can be changed the display order of channels by users.

⑥ Add or delete HOME screen channel.

Settings

Various settings can be configured from Settings on the HOME screen. The follow settings can be configured.

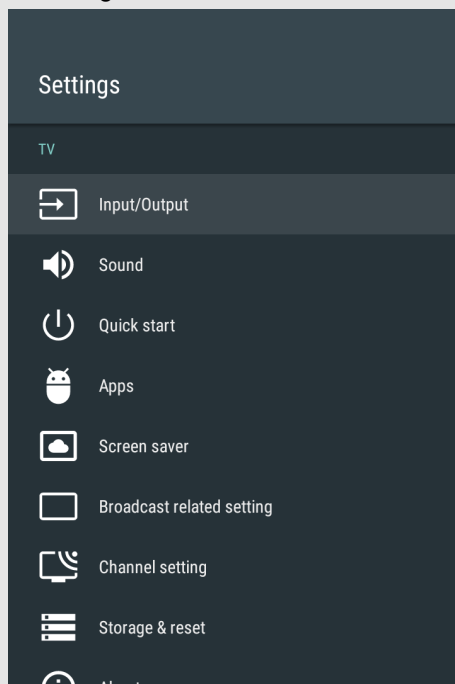

TV	Input/Output: See pages 4-8 to 4-14.
	Sound: System sound and Surround sound.
	Quick start: You can reduce the TV's start-up time after turning on the power with the remote control unit.
	Apps: View a list of applications.
	Screen saver: Set the Screen saver.
	Broadcast related setting: See pages 4-15 to 4-21
	Channel setting: See pages 4-2 to 4-7
	Storage & reset: View the memory usage status or perform a reset. When you perform a reset, the TV will be returned to the factory preset values, and the Google™ Accounts will also be deleted.
	About: Check for system updates and view various information. See page 4-22.

Network & Peripherals	Network	Network setting: Configure the WiFi and Ethernet settings. Wake on LAN: Enable the TV to be started by a signal over a LAN.
		Google Cast: Configure various Chromecast built-in settings.
		RC setting: Switch the Remote Control settings.
		Bluetooth: Add accessory.
System/Function	Date & time	Set the date and time.
	Language	You can select a language. Select from among 12 languages. (English (UK), English (US), French, Portuguese, Simplified Chinese, Indonesian, Thai, Vietnamese, Arabic, Russian and Persian and Malay)
	Keyboard	Switch the keyboard setting.
	Home screen	Home screen customise settings.
	Google	Switch the Google function settings.
	Accessibility	Configure Caption, Talkback, and SwitchAccess settings. Some of the Caption settings may not be applied.
Personal	TV location	Select "Home" or "Store" for the location where you plan to install the TV.
	Location	Configure the location settings.
	Security & restrictions	See pages 4-23 to 4-25.
	Usage & Diagnostics	Help improve your Android TV™ by automatically sending diagnostic and usage data to Google. This information won't be used to identify you and helps teams working on things like apps performance and new Google features. Find out more at http://google.com/AndroidUsageHelp .
Accounts	Power Control	See pages 4-26 to 4-28.
	Add account	Add an account.

NOTE

- The menu may be different depending on when you purchased the TV.

Chromecast built-in compatible devices

When you connect a device such as a Chromecast built-in compatible smartphone or tablet to this TV, you can enjoy video and audio from the device on the TV's large screen and speakers.

- 1 Configure the settings from "HOME" > "Settings" > "Network & Peripherals" > "Google Cast (Chromecast built-in)".
- 2 Enable the Chromecast built-in function on the Chromecast built-in compatible device and connect to the TV.
(The TV screen changes according to the behavior of the device)

NOTE

- When the TV is turned off or the connection is ended on the device, you must connect the device again.
- For details about the operation of the Chromecast built-in compatible device, check the manual for that device.

Tools

The View Setting, Picture and Audio menus can be configured on the Tools screen.
[See pages 3-2, 3-3 to 3-21, and 3-22 to 3-33](#) for details on the settings for each menu.

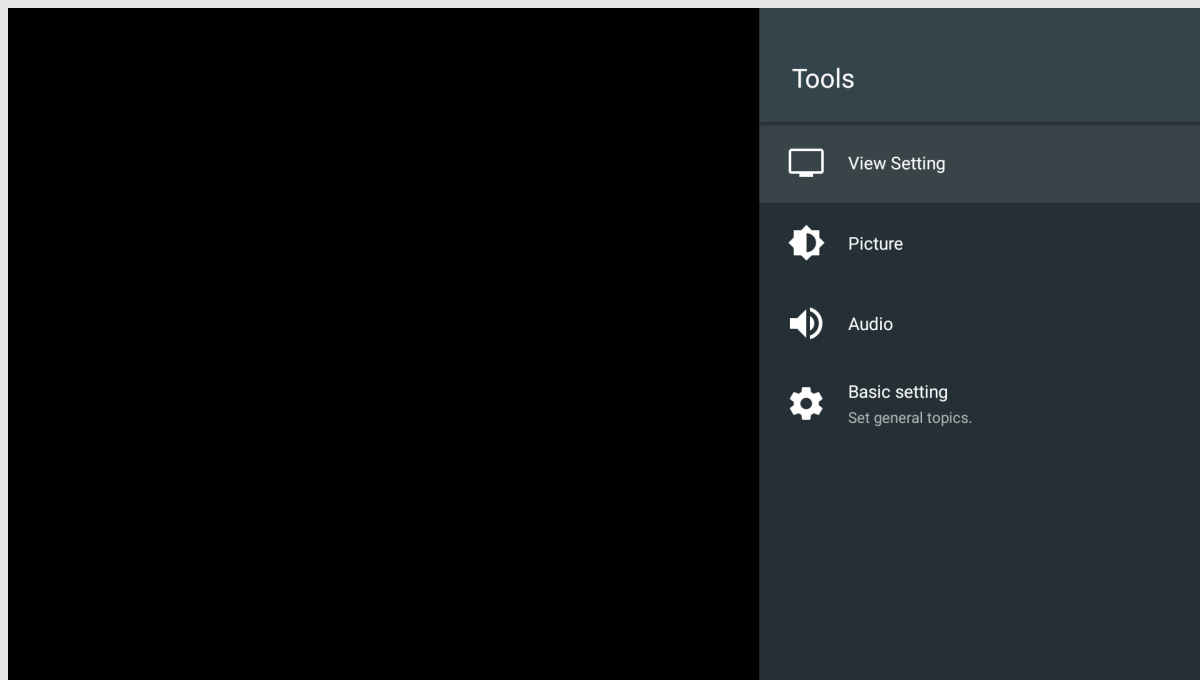



Introduction

About Menu Items

- Some menu items may not be displayed depending on the selected input source.

NOTE

- The screens in the operation manual are for explanation purposes (some are enlarged, others cropped) and may vary slightly from the actual screens.
- The order of explanations for each menu item in the following pages is not necessarily in accordance with the alignment of the items on the screen.

Example

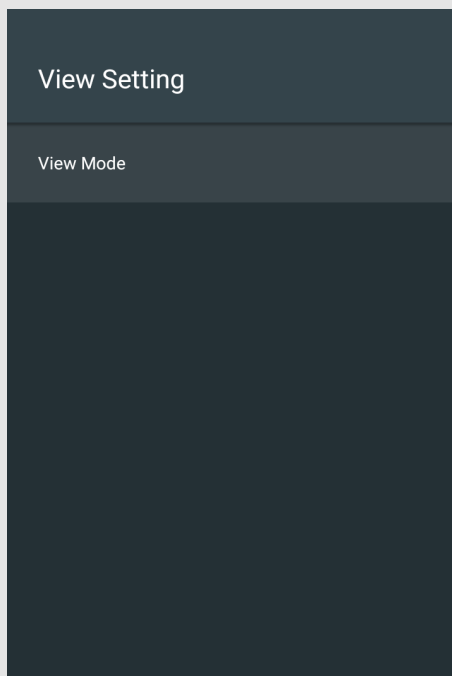

View Setting

View Mode

You can select the screen size.

Normal: Keeps the original aspect ratio in a full screen display.

Full: For 16:9 squeeze pictures.

Cinema 16:9: For 16:9 letterbox pictures. Bars may appear on the top and bottom with some programmes.

Cinema 14:9: For 14:9 letterbox pictures. Bars may appear on the top and bottom with some programmes.

Zoom 14:9: For 14:9 letterbox pictures. A thin side bar appears on each side, and you may also see bars on the top and bottom with some programmes.

Underscan: Displays an image with the same number of pixels on the screen when receiving HD signals only.

Dot by Dot: Detects the resolution of the signal and displays an image with the same number of pixels on the screen.

NOTE

- Some items do not appear depending on the type of received signal.

Example

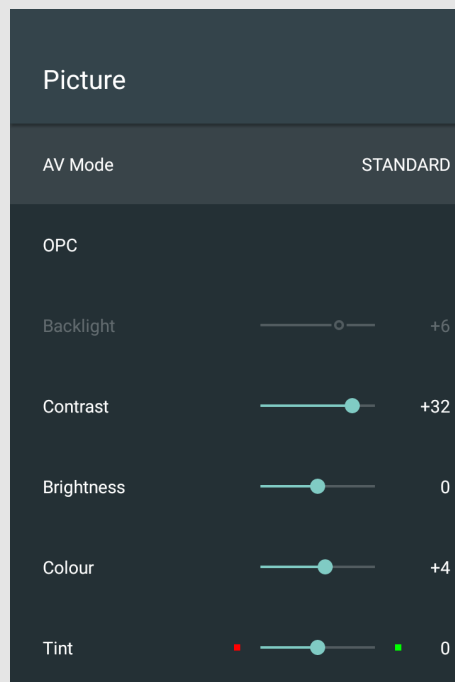

Picture

AV Mode (Changing Pic.Quality)

AV Mode gives you several viewing options to choose from to best match the surrounding environment of the TV, which can vary due to factors like room brightness, type of programme watched or the type of device connected.

These settings will be automatically saved on each input for convenience.

STANDARD: For a highly defined image in a normal lighting.

MOVIE: For a movie.

GAME: Lowers image brightness for easier viewing.

PC: For PC.

PHOTO: For a photo.

DYNAMIC: For a clear-cut image emphasizing high contrast, useful for sports viewing.

DYNAMIC (FIXED): Changes the image and sound settings to the factory preset values. No adjustments are allowed.

NOTE

- When you play games, "GAME" is recommended for AV Mode.
- You can select AV Mode by pressing **AV MODE** on the remote control unit.

Example

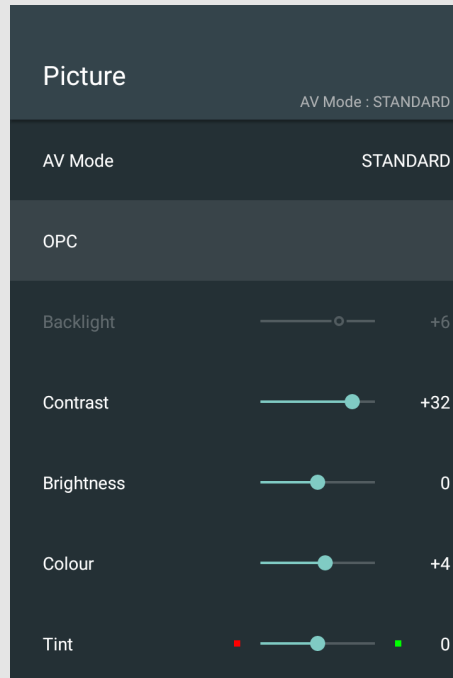

Picture (Continue)

OPC (Light Sensor)(Only for 4T-C50AL1X and 4T-C50AL2X)

Automatically adjusts the brightness of the screen.
Select from the following available settings.

OPC/Display/Max./Min.

NOTE

- When set to "On", the Light Sensor senses the surrounding light and automatically adjusts the backlight brightness. Make sure nothing obstructs the Light Sensor, which could affect its ability to sense surrounding light.

Example

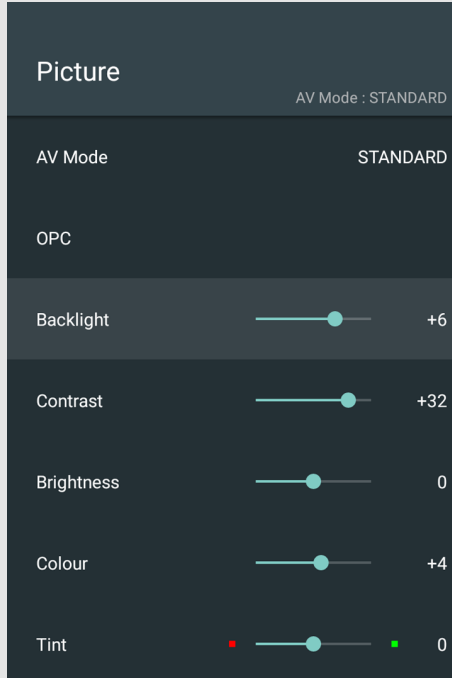

Picture (Continue)

Backlight

Adjusts the picture to your preference with the following picture settings.

Selected item	◀ button	▶ button
Backlight	The screen dims	The screen brightens

NOTE

- "Backlight" is not available when you set "OPC" (Light Sensor) to "On".
(Only for 4T-C50AL1X and 4T-C50AL2X)

Example

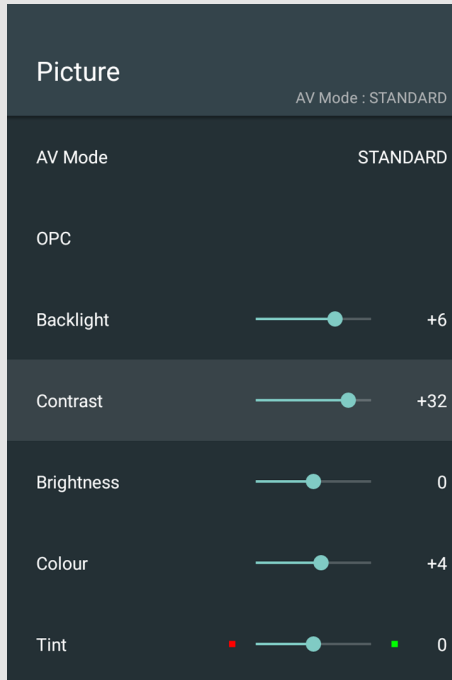

Picture (Continue)

Contrast

Adjusts the picture to your preference with the following picture settings.

Selected item	◀ button	▶ button
Contrast	For less contrast	For more contrast

Example

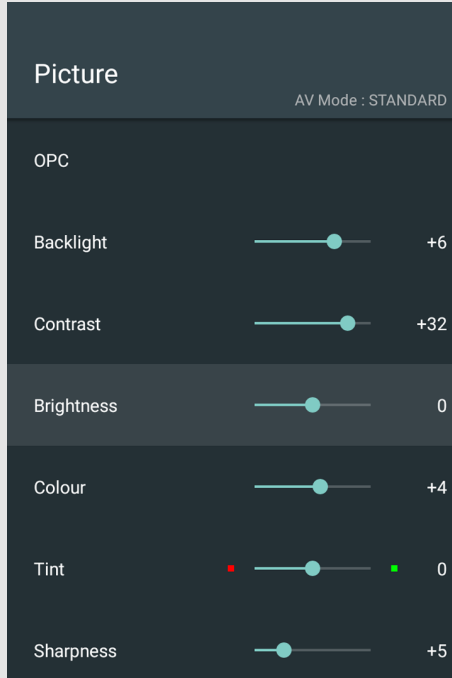

Picture (Continue)

Brightness

Adjusts the picture to your preference with the following picture settings.

Selected item	◀ button	▶ button
Brightness	For less brightness	For more brightness

Example

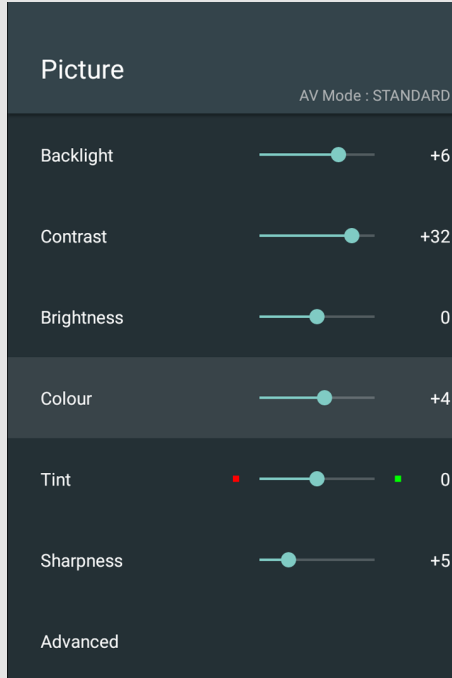

Picture (Continue)

Colour

Adjusts the picture to your preference with the following picture settings.

Selected item	◀ button	▶ button
Colour	For less colour intensity	For more colour intensity

Example

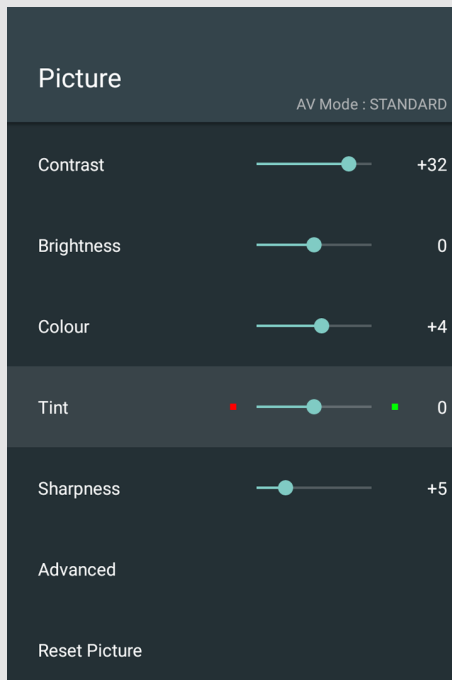

Picture (Continue)

Tint

Adjusts the picture to your preference with the following picture settings.

Selected item	◀ button	▶ button
Tint	Skin tones become reddish	Skin tones become greenish

Example

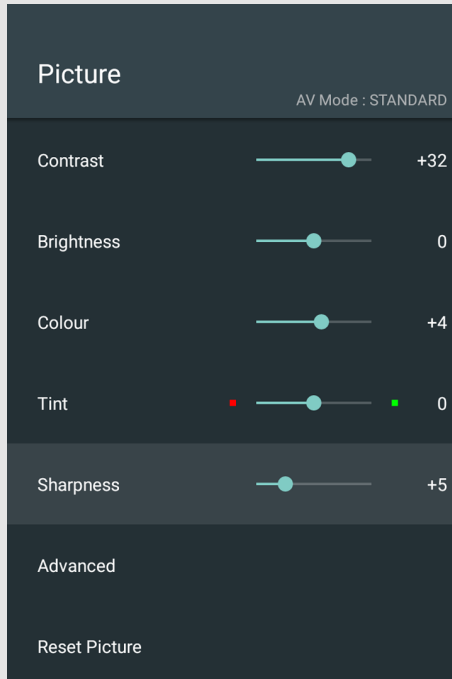

Picture (Continue)

Sharpness

Adjusts the picture to your preference with the following picture settings.

Selected item	◀ button	▶ button
Sharpness	For less sharpness	For more sharpness

Example

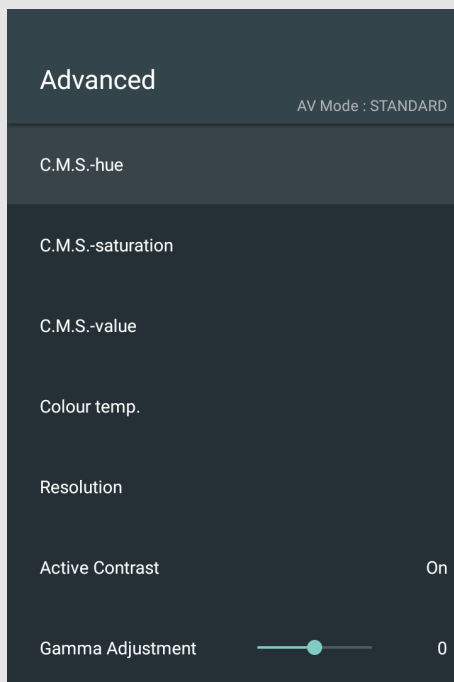

Picture (Continue)

Advanced

C.M.S. (Colour Management System)

Colour tone is managed using the six-colour adjustment setting.

C.M.S.-hue: This is a standard to adjust the colour either more reddish or more bluish in tone.

A lower value makes the image darker.

Example

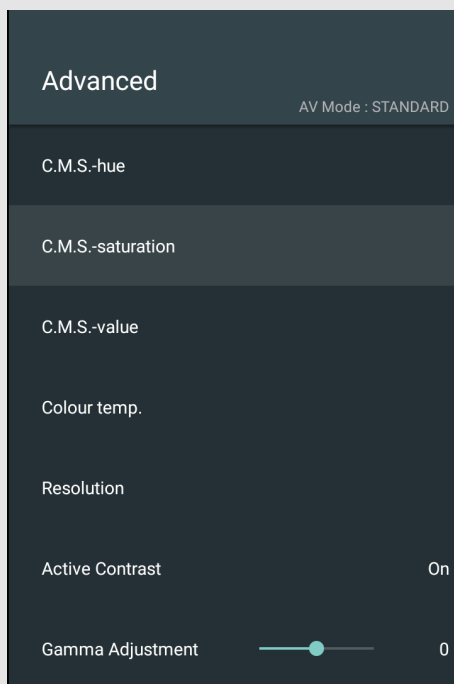

Picture (Continue)

Advanced

C.M.S. (Colour Management System)

Colour tone is managed using the six-colour adjustment setting.

C.M.S.-saturation: Increases or decreases the saturation of a selected colour.

A lower value makes the image darker.

Example

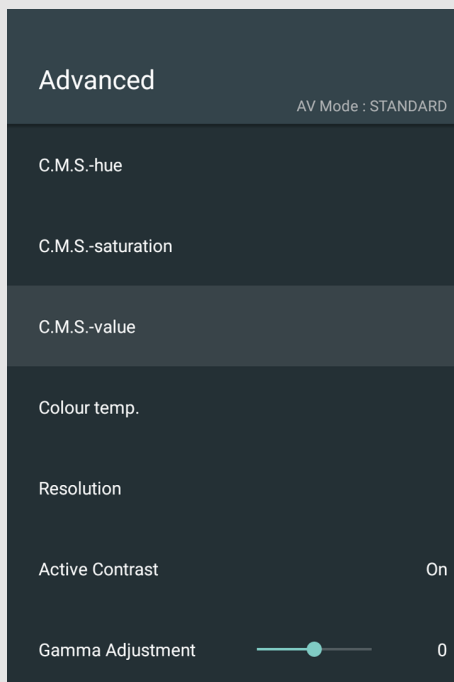

Picture (Continue)

Advanced

C.M.S. (Colour Management System)

Colour tone is managed using the six-colour adjustment setting.

C.M.S.-value: A higher value makes the image brighter.

A lower value makes the image darker.

Example

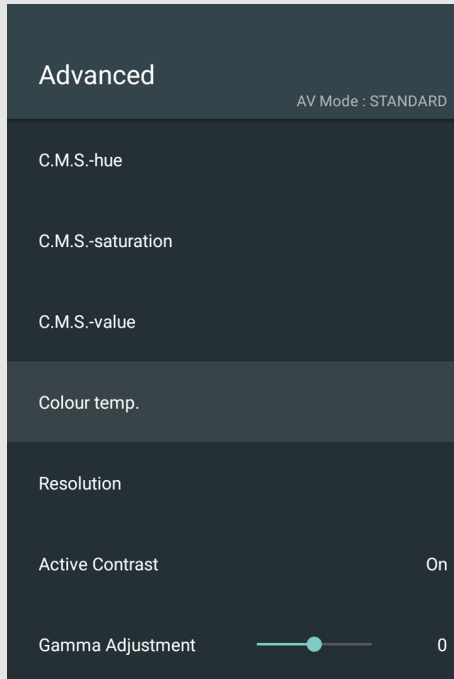

Picture (Continue)

Advanced

Colour temp. (Colour Temperature)

For a better white balance, use colour temperature correction.

- High:** White with bluish tone
- Mid-High:**
- Middle:**
- Mid-Low:**
- Low:** White with reddish tone



Example

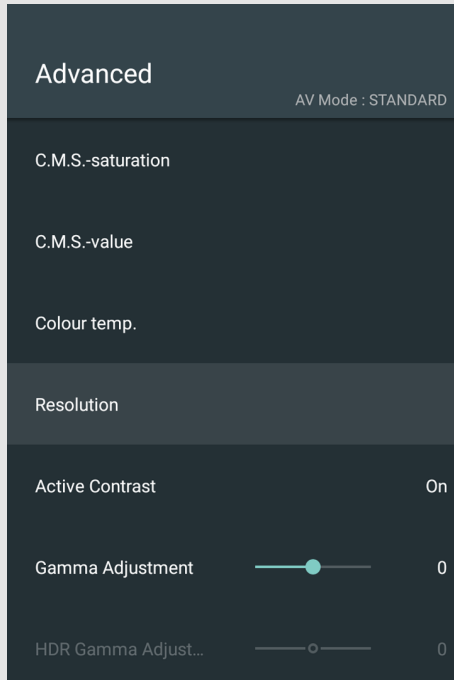

Picture (Continue)

Advanced

Resolution

Please select 4K resolution mode based on your watching preference. Select from the following available settings.

Detail/Wide Edge

Example

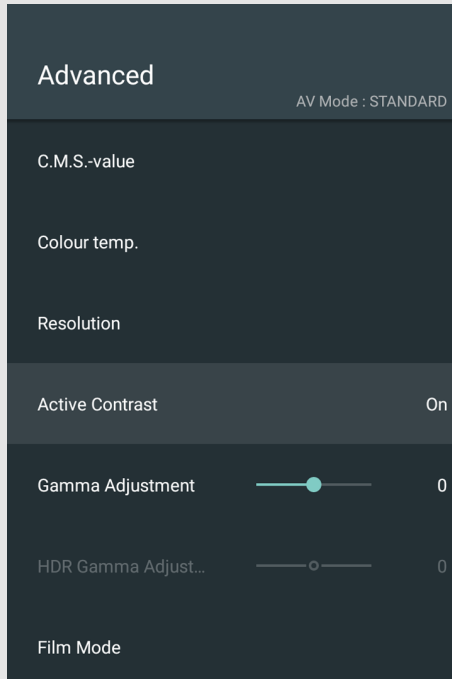

Picture (Continue)

Advanced

Active Contrast

Automatically adjusts the image contrast according to the scene.

On: Produces higher contrast image in any scene.

Off: No adjustment.

Example

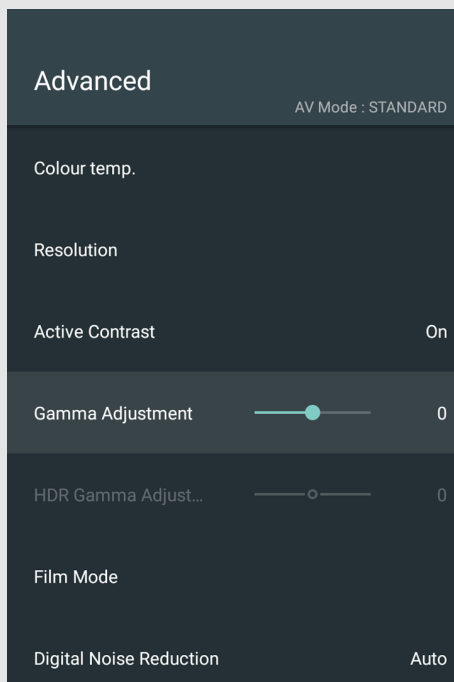

Picture (Continue)

Advanced

Gamma Adjustment

Adjusts the differences of picture tones between bright parts and dark parts. The adjustment range of the gamma can be set to a maximum of +3 and a minimum of -3 by pressing ◀ or ▶.

Example

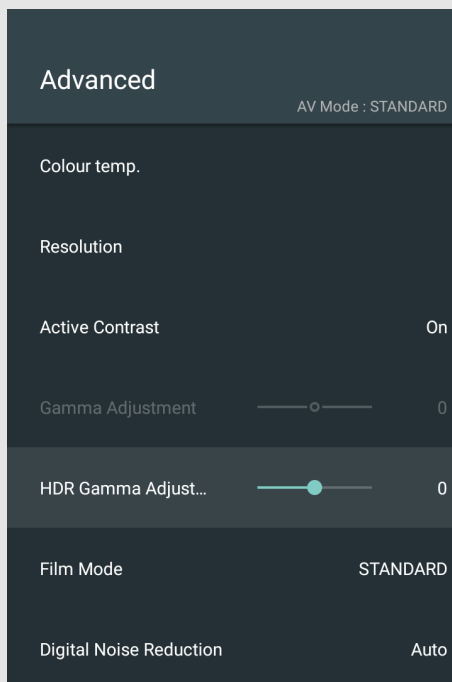

Picture (Continue)

Advanced

HDR Gamma Adjustment

Emphasize the differences of picture tones between bright parts and dark parts. The adjustment range of the gamma can be set to a maximum of +2 and a minimum of -2 by pressing ◀ or ▶.

NOTE

- "HDR Gamma Adjustment" is available only when receiving HDR signal.

Example

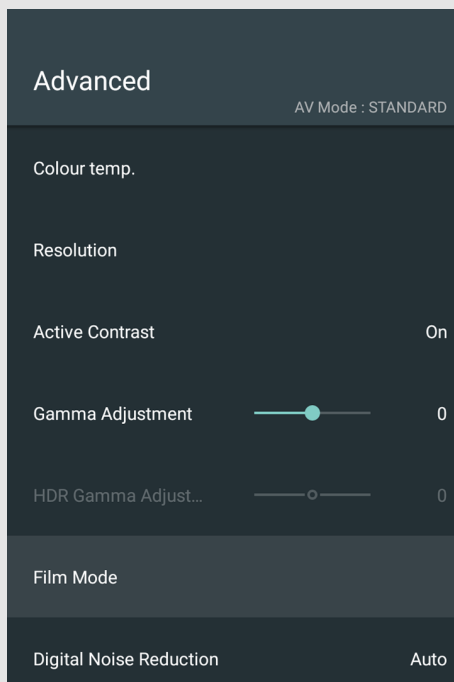

Picture (Continue)

Advanced

Film Mode (3:2 pull-down)

This function provides high-quality playback of images originally encoded at 24 frames/second, such as films. Select from the following available settings.

Advanced/Standard/Off**NOTE**

- "Film Mode" does not function depending on input signal type.

Example

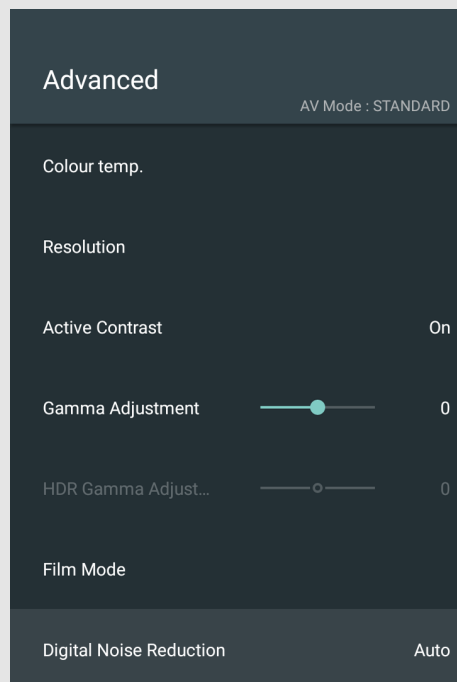

Picture (Continue)

Advanced

Digital Noise Reduction

Produces a clearer video image.

Auto: Automatically adjusts the level of noise reduction.

High/Middle/Low: You can select a desired level for viewing a clearer video image.

Off: No adjustment.

NOTE

- "Digital Noise Reduction" is not available when PC format is being input.

Example

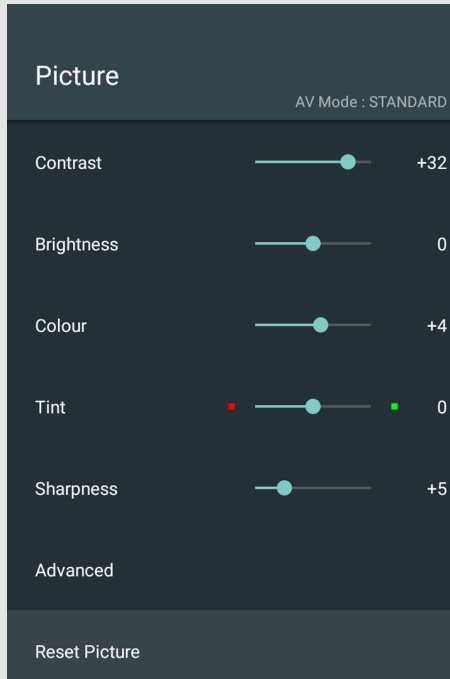

Picture (Continue)

Reset Picture

Returns Picture Settings to their factory preset values. To reset, select "Yes" and then press ● (ENTER).

Example

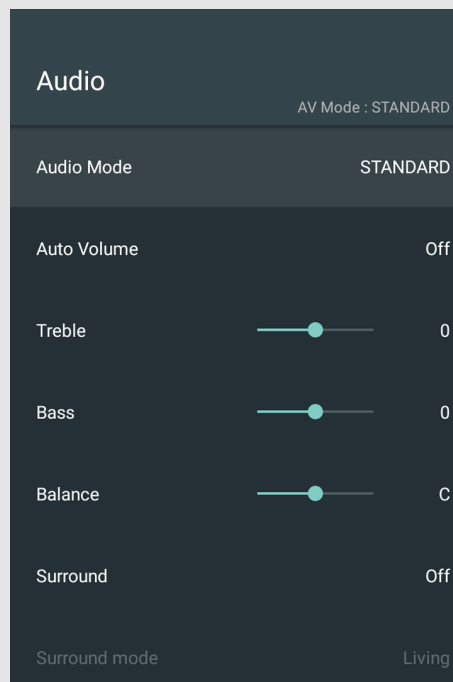

Audio

Audio Mode

This function allows you to convert the audio quality.

Select from the following available settings.

STANDARD/DYNAMIC/CLEAR**NOTE**

- "Audio Mode" is not available when you set "Audio Out" to "Variable".

[\(See page 4-10.\)](#)

Example

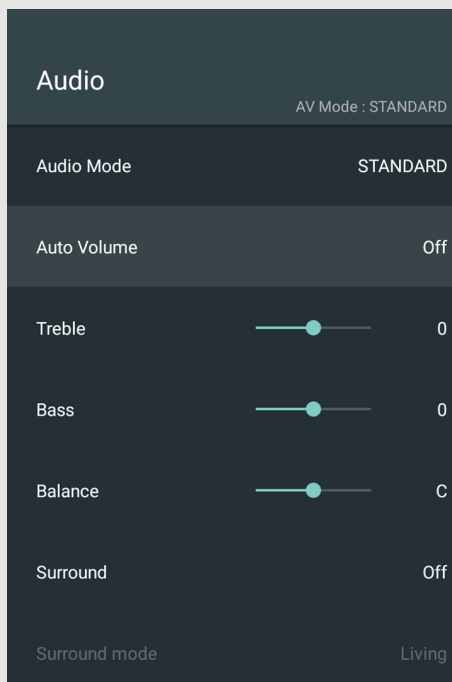

Audio (Continue)

Auto Volume

Different sound sources sometimes do not have the same loudness level, such as a programme and its commercial breaks. The Auto Volume reduces this problem by equalizing it.

On: Reduces the loudness gaps among different sound source. The result is automatically adjusted according to the sound sources.

Off: No adjustment.

NOTE

- "Audio Mode" is not available when you set "Audio Out" to "Variable".
(See [page 4-10.](#))

Example

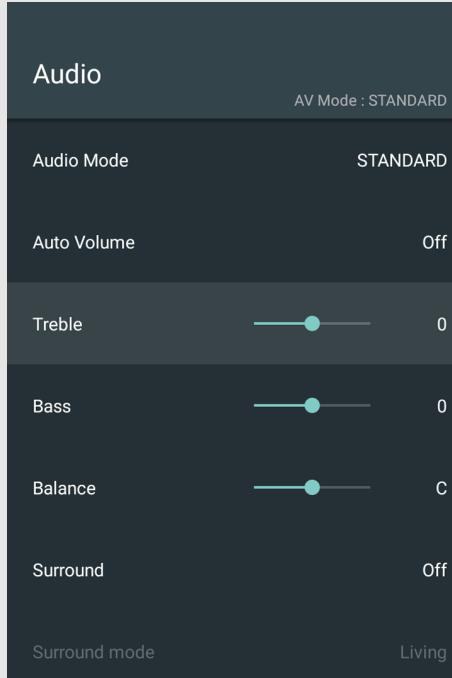

Audio (Continue)

Treble

You can adjust the sound quality to your preference with the following settings.

Selected item	◀ button	▶ button
Treble	For weaker treble	For stronger treble

NOTE

- "Audio Mode" is not available when you set "Audio Out" to "Variable".
[\(See page 4-10.\)](#)

Example

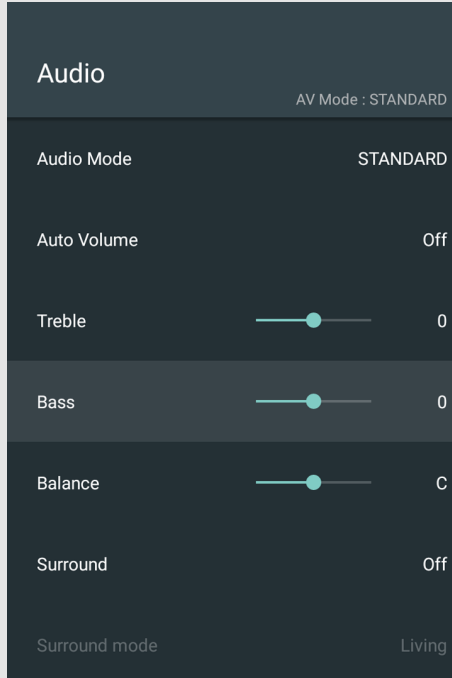

Audio (Continue)

Bass

You can adjust the sound quality to your preference with the following settings.

Selected item	◀ button	▶ button
Bass	For weaker bass	For stronger bass

NOTE

- "Audio Mode" is not available when you set "Audio Out" to "Variable".
[\(See page 4-10.\)](#)

Example

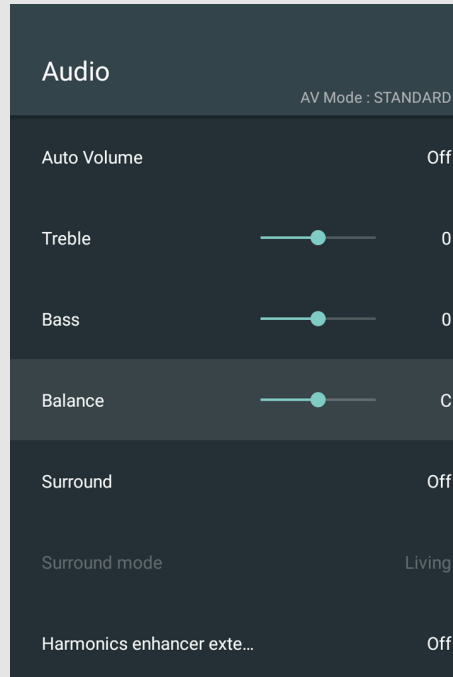

Audio (Continue)

Balance

You can adjust the sound quality to your preference with the following settings.

Selected item	◀ button	▶ button
Balance	Decrease audio from the right speaker	Decrease audio from the left speaker

NOTE

- "Audio Mode" is not available when you set "Audio Out" to "Variable".

[\(See page 4-10.\)](#)

Example

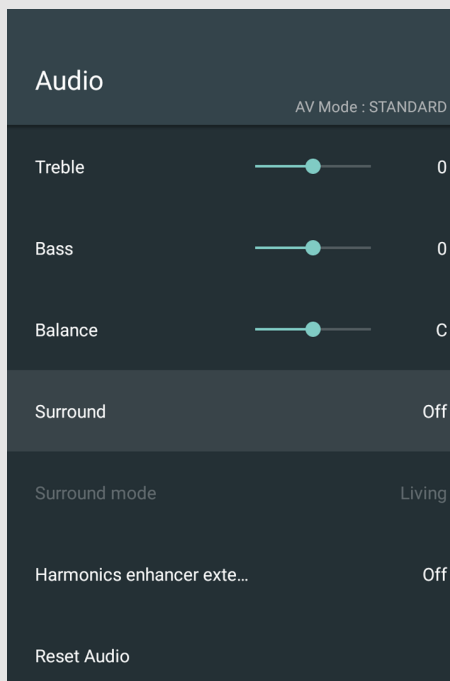

Audio (Continue)

Surround

The surround function produces Surround effect from the speakers.

NOTE

- "Audio Mode" is not available when you set "Audio Out" to "Variable".
[\(See page 4-10.\)](#)
- For some discs, setup may be required on your BD/DVD player. In this case, please refer to the operation manual of your BD/DVD player.

Example

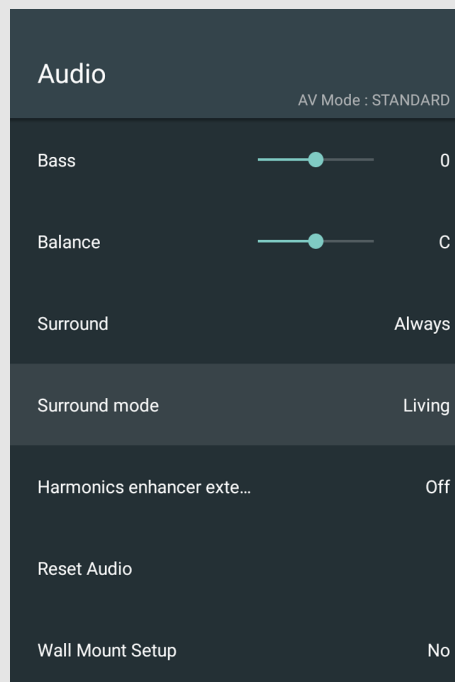

Audio (Continue)

Surround mode

This function allows you to select surround mode for surround on.
Select from the following available settings.

Living/Theater/Hall

NOTE

- "Audio Mode" is not available when you set "Audio Out" to "Variable".
[\(See page 4-10.\)](#)
- "Surround mode" is not available when you set "Surround" to "Off".

Example

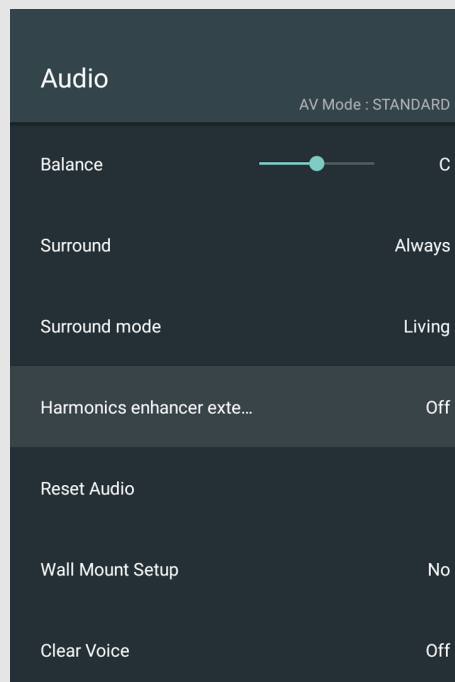

Audio (Continue)

Harmonics enhancer extended

This function improves the sound quality by extending the selected range.
Select from the following available settings.

All Range/Low Range/Off**NOTE**

- "Audio Mode" is not available when you set "Audio Out" to "Variable".

[\(See page 4-10.\)](#)

Example

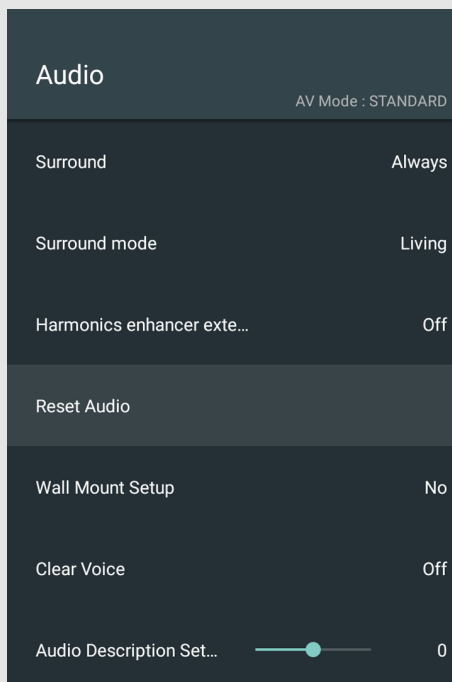

Audio (Continue)

Reset Audio

Returns Audio Settings to their factory preset values. To reset, select "Yes" and then press ● (ENTER).

NOTE

- "Audio Mode" is not available when you set "Audio Out" to "Variable".
[\(See page 4-10.\)](#)



Example

Audio	
Surround	Always
Surround mode	Living
Harmonics enhancer exte...	Off
Reset Audio	
Wall Mount Setup	No
Clear Voice	Off
Audio Description Set...	0

Audio (Continue)

Wall Mount Setup

This selects the optimal audio for the programme you are currently watching even when the TV is mounted to a wall.

Example

Audio	
Surround	Always
Surround mode	Living
Harmonics enhancer exte...	Off
Reset Audio	
Wall Mount Setup	No
Clear Voice	Off
Audio Description Set...	 0

Audio (Continue)

Clear Voice

This function emphasises speech against background noise for greater clarity. Select from the following available settings.

Normal/Low/High/Off

NOTE

- "Audio Mode" is not available when you set "Audio Out" to "Variable".
[\(See page 4-10.\)](#)

Example

Audio	
Surround	Always
Surround mode	Living
Harmonics enhancer exte...	Off
Reset Audio	
Wall Mount Setup	No
Clear Voice	Off
Audio Description Set...	0

Audio (Continue)

Audio Description Setting (DTV only)

This function allows you to enable output of audio description if the TV receives a signal including audio description.

NOTE

- The audio description sound is superimposed on the main audio when you select a broadcast compatible with audio description.
- This function is available only for DTV broadcasts.
- The audio description sound is superimposed on the main audio only when the sound is output on the speaker sound output, headphone sound output and sound for audio out output. The sound is not output on the digital audio output and the HDMI sound output.
- This function is not available for the AQUOS Audio speaker system.
- This function does not work during USB-recording playback.

TV

Channel Setting

Auto installation

When the TV is powered on for the first time after purchase, the initial auto installation wizard appears. Follow the menus and make the necessary settings one after another.

Confirm the following before turning on the power

- Is the antenna cable connected?
- Is the AC cord plugged in?

1 Press **POWER** on the TV.

- The initial auto installation wizard appears.

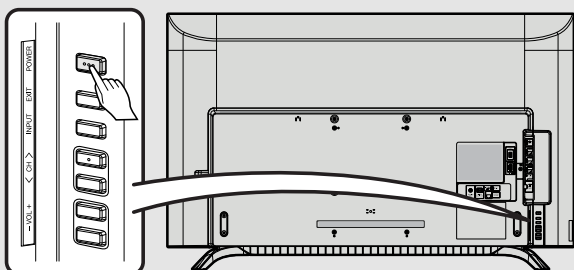

2 Setting the OSD language.

Press ▲ / ▼ to select the desired language, and then press ● (ENTER).

3 Press "Yes" or "No" to allow Android™ device (phone, tablet or other device) to setup TV.

4 Press ▲ / ▼ to select your Wi-Fi network.

5 Press ▲ / ▼ to sign in Google account.

6 Press ▲ / ▼ to view Google Terms of Service and Google Privacy Policy.

7 Press "Yes" or "No" to allow Google use your device location.

8 Press "Yes" or "No" to set permission for Google to use your TV diagnosis and usage data.

9 Press ▲ / ▼ to select desired TV name or to customize it.

10 Press ▲ / ▼ to install desired applications.

11 Setting the country.

Press ▲ / ▼ to select your country or area, and then press

● (ENTER).

- This setting screen only appears during the initial auto installation.
- Auto installation will be executed.

NOTE

- Digital (DVB-T/T2) broadcasting cannot be viewed in the area where digital broadcasting is not yet launched.
- DTV concerned menu may not displayed in some country.

12 Press ▲ / ▼ to view Sharp Terms of Use and Sharp Privacy Policy.

13 Selecting the location of the TV.

Press ▲ / ▼ to select where you will use this TV, and then press

● (ENTER).

Home:

- Settings are optimised for normal home viewing and energy efficiency.
- "STANDARD" will be the default value for the "AV Mode" setting.

Store:

- Settings are designed for maximum impact in retail store displays.
- "DYNAMIC (FIXED)" will be the default value for the "AV Mode" setting. If the "AV Mode" is changed, the TV will automatically switch back to "DYNAMIC (FIXED)" when there is no operation using the TV or remote control unit for 30 minutes.

NOTE

- Store: A demonstration image will be displayed after initial auto installation is completed. If you have chosen "Store" by mistake, go to "HOME" > "Settings" > "System/Function" > "TV location" > select "Home" again.

14 You have to follow the procedure shown below to pair the remote control unit with the TV.

15 Initial setup has finished.

16 After completing the initial setup, application introductions and tutorials will be displayed.



Example

- Channel Setting
- Channel Search
- Channel Registration
- Channel Skip
- Programme Setup

TV (Continue)

Channel Setting

Channel Search

Auto-Searching digital (DVB-T/T2) and analogue broadcasting channels.



Example

- Channel Setting
- Channel Search
- Channel Registration
- Channel Skip
- Programme Setup

TV (Continue)

Channel Setting

Channel Registration

You can add new channels from your installed 3rd party TV apps. Once you've added new channels, you can watch 3rd party TV app channels on [TV] input, which can be chosen from Home screen and Input menu.



Example

- Channel Setting
- Channel Search
- Channel Registration
- Postcode
- Time zone
- Channel Skip
- Programme Setup

TV (Continue)

Channel Setting

Postcode (Indonesia only)

This function enable you to select your local postcode.

Time Zone (Indonesia only)

This function enable you to select your local time zone.

NOTE

- "Postcode" and "Time Zone" will be appear only when country "Indonesia" is selected.



Example

- Channel Setting
- Channel Search
- Channel Registration
- Channel Skip
- Programme Setup

TV (Continue)

Channel Setting

Channel Skip

You can select the channels to skip.

Example

Channel Setting

Channel Search

Channel Registration

Channel Skip

Programme Setup

TV (Continue)**Channel Setting****Programme Setup**

You can tune channels manually and you can confirm DTV's signal level.

Digital Setting (DTV only)

You can reconfigure the DTV channel settings automatically or manually.

Manual Search

Add new services within a specified frequency band.

- Enter the frequency using ▲ / ▼ buttons.

NOTE

- The “Digital Setting” menu is available only for watching TV in DTV mode.

Analogue Setting

You can reconfigure the TV channel settings automatically or manually.

Frequency

Tune the frequency of the stored channel to your desired position.

Sound Sys.

Select the optimum sound system (Broadcasting system) to received (B/G, D/K, I, M).

NOTE

- The “Analogue Setting” menu is available only for watching TV in ATV mode.



Example

Programme Setup

Digital Setting

Antenna setup-DIGITAL

TV (Continue)

Channel Setting

Programme Setup

Antenna setup-DIGITAL

If you install a DTV antenna for the first time or relocate it, you should adjust the alignment of the antenna to receive a good reception while checking the antenna setup screen.

Signal State

Signal Strength

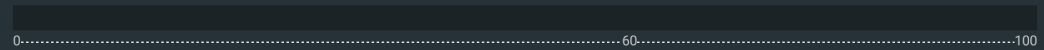

Current: -1 Max: 0

Signal Quality

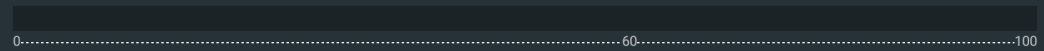

Current: 0 Max: 0



Example

Input/Output
Consumer Electronic Control (CEC)
HDMI Type Selection Limited
Audio Out Fixed
Audio Select HDMI
Digital Audio Output PCM
Speaker Select (ARC) Internal Speaker
Input label

TV (Continue)

Input/Output

Consumer Electronic Control (CEC)

Change the label for an input terminal, and switch between HDMI CEC Control Settings.



Example

- Input/Output
- Consumer Electronic Control (CEC)
- HDMI Type Selection
Limited
- Audio Out
Fixed
- Audio Select HDMI
- Digital Audio Output
PCM
- Speaker Select (ARC)
Internal Speaker
- Input label

TV (Continue)

Input/Output

HDMI Type Selection

Sets the HDMI type for HDMI IN 1 and 2 terminals.
Set to "Full" when an HDMI 4K60P 4:4:4 device is connected, and set to "Limited" when an HDMI 4:2:0 device is connected.

Example

Input/Output
Consumer Electronic Control (CEC)
HDMI Type Selection Limited
Audio Out Fixed
Audio Select HDMI
Digital Audio Output PCM
Speaker Select (ARC) Internal Speaker
Input label

TV (Continue)

Input/Output

Audio Out

Allows you to select what controls the audio output.

Fixed: Sound via speaker is adjusted with **VOL+/-** on the remote control unit or on the TV.
Sound via the AUDIO OUT terminal is not adjustable and outputs at a consistent level.

Variable: Sound via the AUDIO OUT terminal is adjusted with **VOL+/-** on the remote control unit or on the TV.
When connected to the terminal, Sound via speaker is muted.

Example

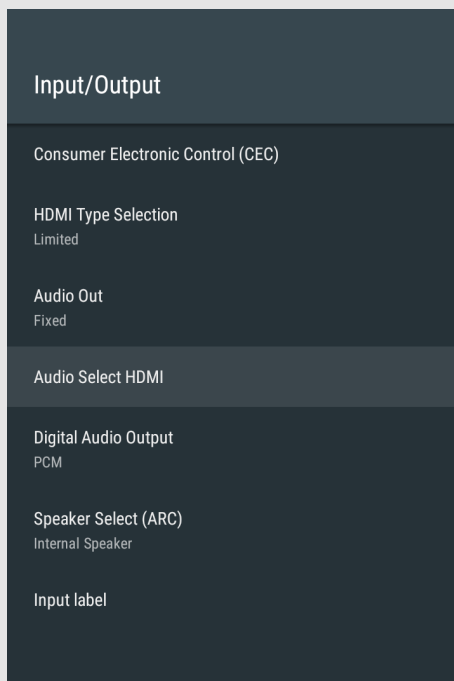

TV (Continue)

Input/Output

Audio Select HDMI

This function sets the terminal to output the computer audio.

The adjustment items vary depending on the input source. Select the input source corresponding to the terminal connected to the PC and then adjust the desired item.

To perform the operation, refer to "HOME" > "Settings" > "TV" > "Input/Output" > "Audio Select HDMI".

HDMI 3

HDMI: Select this when the TV and PC are connected using an HDMI-certified cable and audio is input via the same cable.

HDMI+AV Input: Select this when the TV and PC are connected using a HDMI-certified cable and the audio is input via a Ø 3.5 mm stereo minijack.

NOTE

- When "Audio Select HDMI" is set to "HDMI+AV Input", sound will not be produced if you use only an HDMI-certified cable to connect HDMI-compatible equipment. To produce sound, you should make an analogue audio connection.
- If you want to connect HDMI-compatible equipment using only an HDMI-certified cable, set "Audio Select HDMI" to "HDMI".
- "Audio Select HDMI" can only be set for the HDMI IN 3.

Example

Input/Output
Consumer Electronic Control (CEC)
HDMI Type Selection Limited
Audio Out Fixed
Audio Select HDMI
Digital Audio Output PCM
Speaker Select (ARC) Internal Speaker
Input label

TV (Continue)

Input/Output

Digital Audio Output

You can output digital audio to an AV amplifier or similar device whose DIGITAL AUDIO INPUT terminal is connected to the DIGITAL AUDIO OUT terminal on the TV. Please select an audio output format compatible with the audio format of the programme you are watching and the equipment connected. Select from the following available settings.

PCM/Dolby Digital/Bitstream (SPDF)/Bitstream (ARC)**NOTE**

- Analogue channel audio, Video input audio, PC input audio and HDMI-Analogue input audio are output in PCM mode even when "Bitstream" is selected.
- PCM digital input signals are output in PCM mode even when "Bitstream" is selected.

Example

Input/Output
Consumer Electronic Control (CEC)
HDMI Type Selection Limited
Audio Out Fixed
Audio Select HDMI
Digital Audio Output PCM
Speaker Select (ARC) Internal Speaker
Input label

TV (Continue)

Input/Output

Speaker Select (ARC)

You can select to listen to the TV sound only from the LINK-compatible audio system.

Internal Speaker: The sound is output from the TV speaker.

External Devices: The sound from the TV speaker is muted and only the sound from the LINK-compatible audio system is audible.

- You can use **VOL+/-** and **MUTE**.



Example

Input/Output

Consumer Electronic Control (CEC)

HDMI Type Selection
Limited

Audio Out
Fixed

Audio Select HDMI

Digital Audio Output
PCM

Speaker Select (ARC)
Internal Speaker

Input label

TV (Continue)

Input/Output

Input label

This function allows you to change HDMI names individually.

Example: HDMI 1

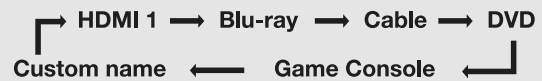



Example

Broadcast related setting

Programme Title Display
Display programme title when changing channels.

Auto Wide (DTV)
Setting Auto Wide (DTV)

Text Language
West Europe

Initial Teletext Page
Malay

Digital Audio Language

Subtitle

Download Setting
Software download automatically?

TV (Continue)

Broadcast related setting

Programme Title Display (DTV only)

This function allows you to display programme information such as the title and airtime by tuning a channel.

NOTE

- This function is available only when the DTV mode is selected.



Example

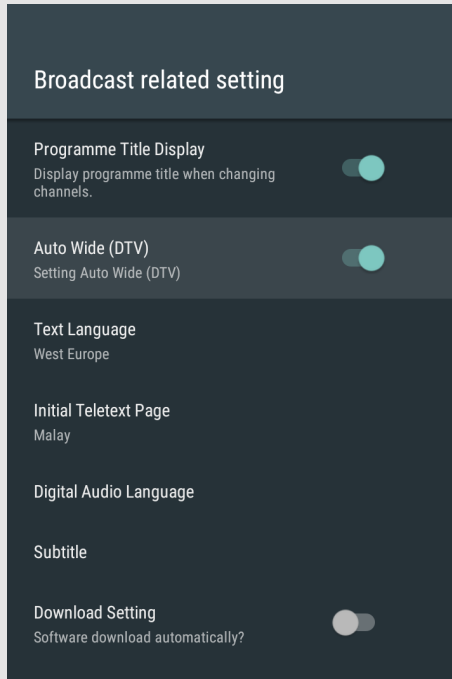

TV (Continue)

Broadcast related setting

Auto Wide (DTV only)

The “Auto Wide” allows the TV to switch automatically among the different picture size.

NOTE

- Use “View Mode” if an image does not switch to the appropriate picture size. When the broadcast signal contains no aspect ratio information, the function will not work even if enabled.

Example

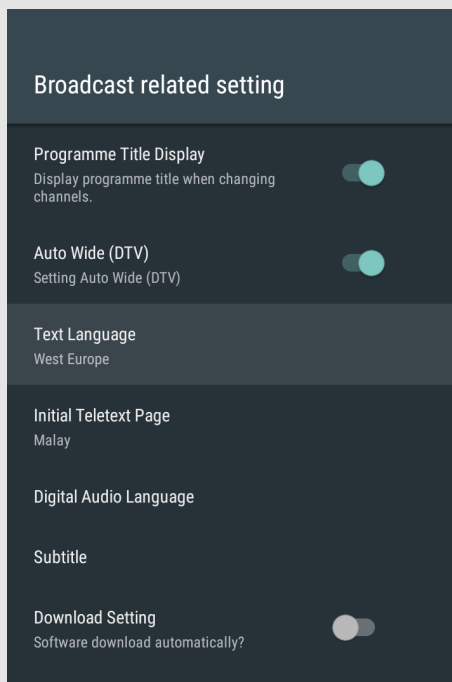

TV (Continue)

Broadcast related setting

Text Language

If Teletext information does not display correctly, perform the procedure below.

Select from among six kinds of language tables: West Europe, East Europe, Greek/Turkish, Cyrillic, Arabic and Farsi.

Each table is compatible with the Teletext languages listed below.

- West Europe — English, French, Scandinavian, Turkish, German, Spanish, Italian
- East Europe — Polish, French, Scandinavian, Czech, German, Slovenian/Croatian, Italian, Rumanian
- Greek/Turkish — English, French, Scandinavian, Turkish, German, Spanish, Italian, Greek
- Cyrillic — English, Russian, Estonian, Czech, German, Slovenian/Croatian, Ukrainian, Lettish
- Arabic — English, French, Scandinavian, Turkish, German, Hebrew, Italian, Arabic
- Farsi — English, French, Scandinavian, Turkish, German, Hebrew, Italian, Farsi

NOTE

- Teletext can be displayed only when it is sent by a network. Not used to convert between languages.

Example

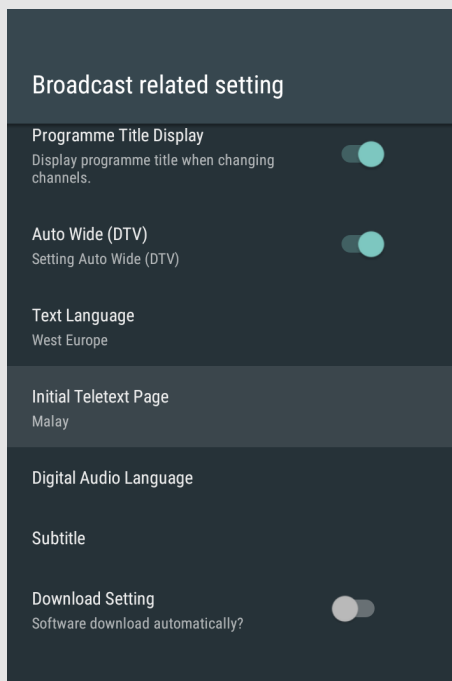

TV (Continue)

Broadcast related setting

Initial Teletext Page (DTV only)

If you set the language of the initial page (this page is displayed for the first time after pressing ) for teletext in DTV mode, it will start from the selected language page.

NOTE

- This function is available for teletext in DTV mode. This is not available for teletext in ATV or external input mode.
- If the initial teletext page of the selected language in this function is not included in a received broadcast, the default initial page will be displayed.



Example

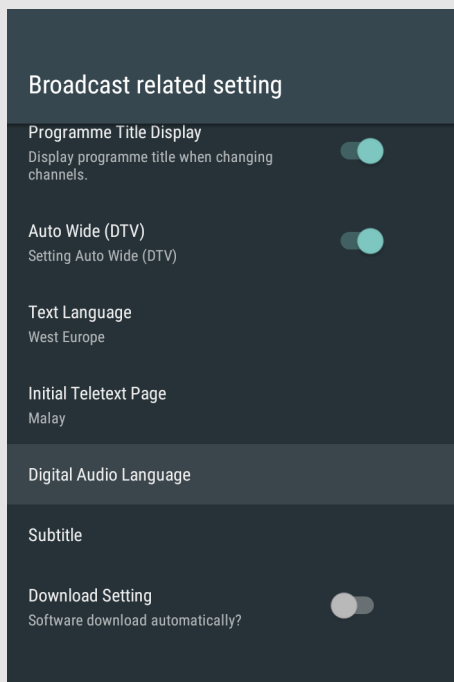

TV (Continue)

Broadcast related setting

Digital Audio Language (DTV only)

Switching the multi audio languages

Set up to two preferred multi audio languages to display if the audio languages are available. Each time you press **AUDIO AD** on the remote control unit, the audio language switches.

NOTE

- This function depends on audio language information from broadcasters.
- If audio for the selected language is not included in a received broadcast, audio will not be output for that language.

Example

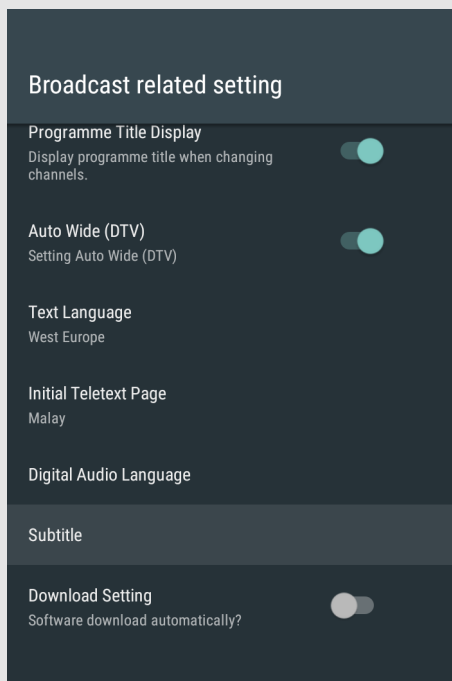

TV (Continue)

Broadcast related setting

Subtitle

Set up to two preferred subtitle languages (including subtitles for the hearing impaired) to display if subtitles are available.

Selectable items

- 1st language
- 2nd language
- For Hearing Impaired

Switching subtitle languages

Each time you press  on the remote control unit, the subtitle switches.

Set “For Hearing Impaired” to “Yes”

Subtitles for the hearing impaired have priority over each of the subtitle language settings (e.g., “1st language”, “2nd language”, etc.).

NOTE

- Subtitles will not be displayed when the programme does not contain subtitle information.



Example

Broadcast related setting

Programme Title Display
Display programme title when changing channels.

Auto Wide (DTV)
Setting Auto Wide (DTV)

Text Language
West Europe

Initial Teletext Page
Malay

Digital Audio Language

Subtitle

Download Setting
Software download automatically?

TV (Continue)

Broadcast related setting

Download Setting

Searching for updates

The TV automatically determines whether a new software version is available when the TV is in standby mode.

Item	
Enable	Automatically searches for new software updates available when the TV is in standby mode.
Disable	Does not search for update information.



TV (Continue)

Software Updates via Over-The-Air (OTA)

To search for new software updates, there are 2 ways to configure:

1) Settings Icon from Home Screen

"Settings" > "About" > "System update" > "Perform the update".

2) **TOOL** button on the remote control unit

"Tools" > "Basic setting" > "About" > "System update" > "Perform the update".

- Select "Network update" if the TV is connected to Internet.
- Select "USB update" if you have the software installed in your USB devices. (for service only)

NOTE

- Make sure your TV is connected to the internet when performing software updates via OTA.
- After finished downloading, please allow some time to apply the installed updates.
- During installation, please do not perform any operations, including power off or unplug your TV.
- Software updates performance is depending on internet connection.
- For allowing software updates notification, select On under "Latest software notification". (Default Setting is On)
- To disable software updates notification, please select Off.



Example

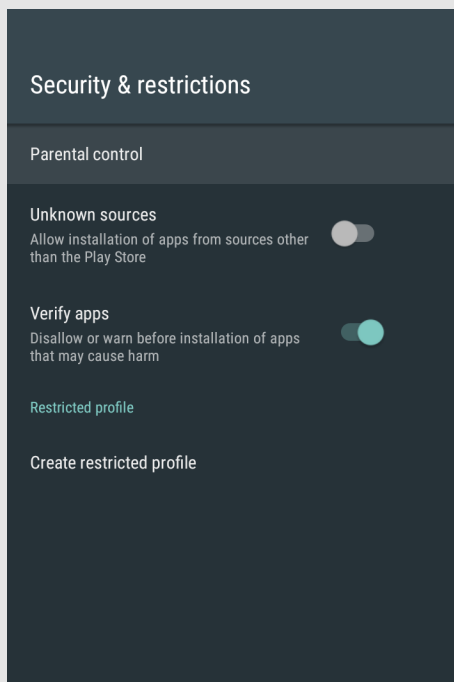

Personal

Security & restrictions

Parental control (DTV only)

Password

Allows you to use a Password to protect certain settings from being accidentally changed.

Input Password:

Input the Password currently set.

Setting Password:

You can set and change the Password by using 0-9.

NOTE

- As a precautionary measure, make a note of your Password and keep it in a familiar place.
- The TV Channel Setup and Parental Control will not be selectable from the menu if you do not first configure your Password.



Example

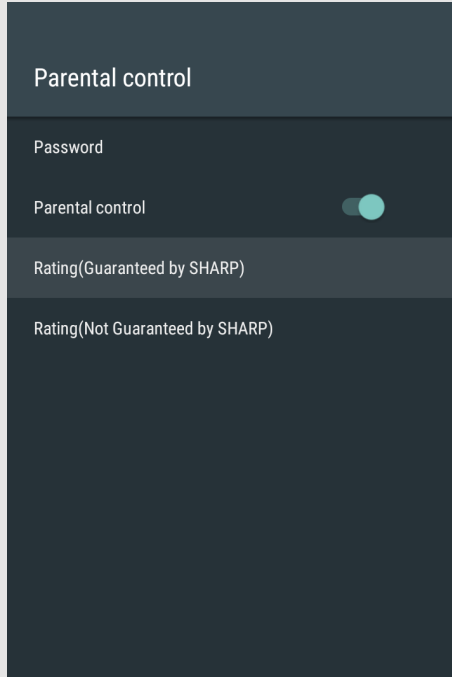

Personal (Continue)

Security & restrictions

Parental control (DTV only)

Used to enable or disable the parental control function. This function will not be selectable from the menu if you do not first configure your password.

Rating (Guaranteed by SHARP)

Singapore

No limitation: No blocking.

General (G): Suitable for all ages.

Parental Guidance (PG): Suitable for all, but parents should guide their young.

Parental Guidance 13 (PG13): Suitable for persons ages 13 and above but parental guidance is advised for children below 13.

No Children Under 16 (NC16): Suitable for persons aged 16 and above.

Mature (M18): Suitable for persons aged 18 and above.

Restricted 21 (R21): Restricted to persons aged 21 and above.

Thailand

No limitation: No blocking.

Preschool: Suitable for preschool aged 3-5 years old.

Children: Suitable for children between 6-12 years old.

General (G): Suitable for all ages.

Parental Guidance 13 (PG13): Suitable for persons ages 13 and above but parental guidance is advised for children below 13.

Parental Guidance 18 (PG18): Suitable for persons ages 18 and above but parental guidance is advised for children below 18.

Adults: Unsuitable for children and youngsters.

Rating (Not Guaranteed by SHARP)

This is used in countries other than Singapore and Thailand.



Example

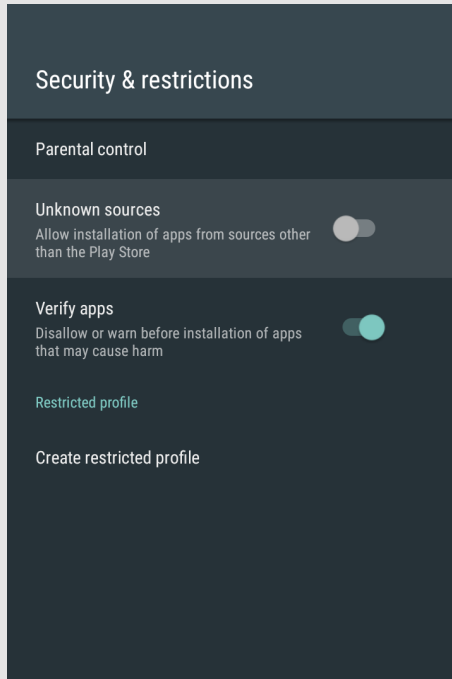

Personal (Continue)

Security & restrictions

Unknown sources

Allow installation of apps from sources other than the Play Store.

Verify apps

Disallow or warn before installation of apps that may cause harm.

Create restricted profile

Configure the restriction settings.



Example

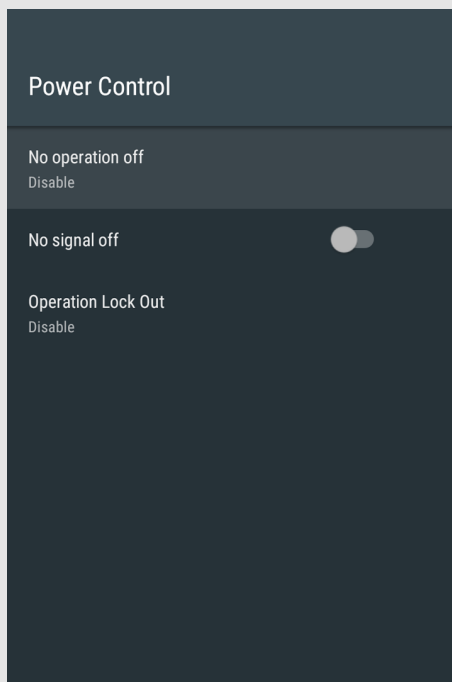

Personal (Continue)

Power Control

No operation off

When you enable this function, the TV automatically shuts down if no operation is performed for more than 3 hours. (30 min/1 hour/3 hours/Disable)

NOTE

- When it is 5 minutes before the power shuts down, the remaining time will start to keep appearing every minute.

Example

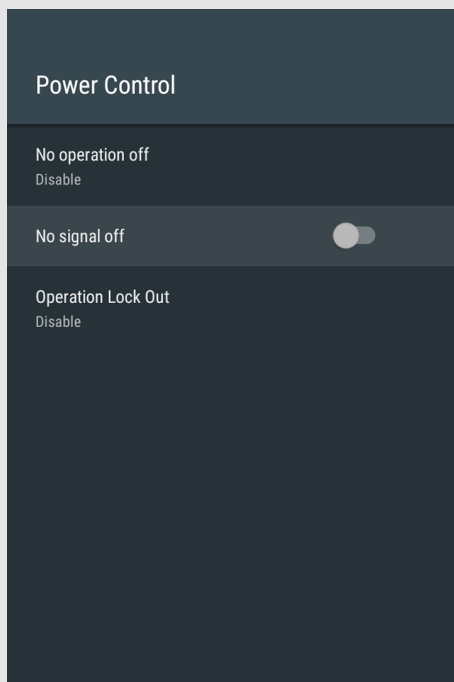

Personal (Continue)

Power Control

No signal off

When this function is enabled, the TV automatically shuts down if no signal is received for more than 15 minutes.

NOTE

- When it is 5 minutes before the power shuts down, the remaining time will start to keep appearing every minute.
- When a TV programme finishes, this function may not operate.



Example

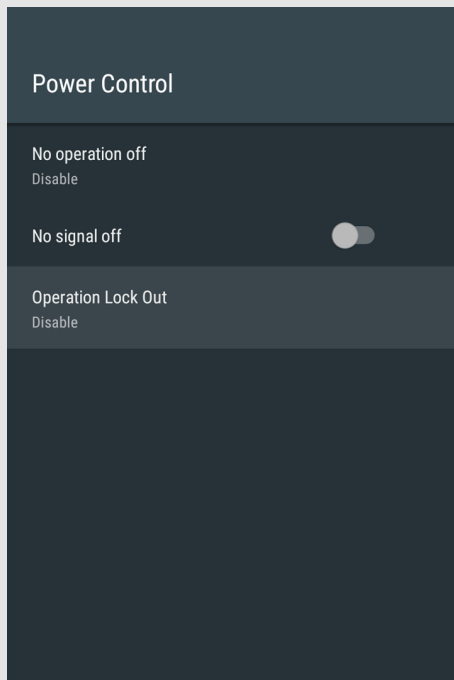

Personal (Continue)

Power Control

Operation Lock Out

This function locks the operation buttons on the TV.

Disable: No adjustment.

Button Control Lock: All buttons on the TV, except **POWER**, are locked.



Example

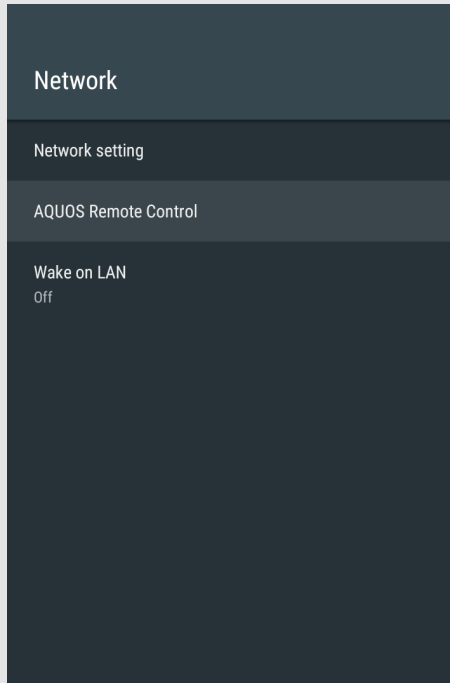

Network & Peripherals

Network

AQUOS Remote Control

Set this function when operating the TV from equipment connected by LAN or wireless LAN.

Remote Control App

When "Remote Control App" is selected, "Change" will be highlighted. Press ● (ENTER).

Detailed Settings

Make the detailed settings (Login ID, password).

Follow the on-screen instructions to configure the settings.

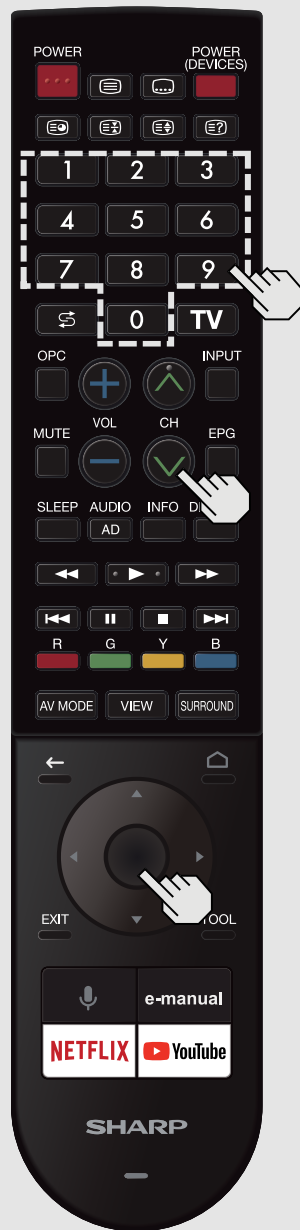

Changing Channels

You can change channels in several ways.

Method 1

Using **CH** \wedge / \vee on the remote control unit or on the TV.

Method 2

Using remote control buttons **0-9**.

Examples:

To select a 1 or 2-digit channel number (e. g., Channel 5):

Press **5** → ● (ENTER)

To select a 3-digit channel number (e. g., Channel 115):

Press **1** → **1** → **5** → ● (ENTER)

NOTE

- When selecting a 1-digit channel number, it is not necessary to press **0** before the number.
- When you enter **0-9** only, channel selection will be made if there is no operation within a few seconds.
- If you push "0" by itself, nothing will happen.
- Complete the above steps within a few seconds.

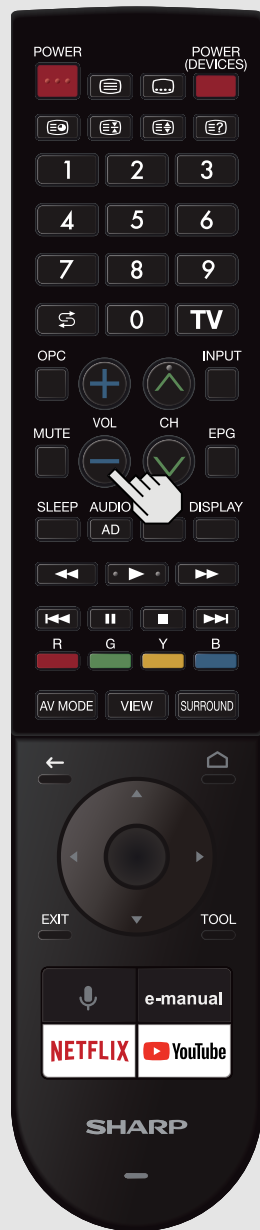

Changing Volume

You can change the volume by pressing **VOL +/-** on the TV or on the remote control unit.

- To increase the volume, press **VOL +**.
- To decrease the volume, press **VOL -**.



Audio status

Output device	Output Select	
	Fixed	Variable
TV Speaker	Variable Sound	Mute
AUDIO OUT	Fixed Sound (Volume MAX)	Variable Sound
DIGITAL AUDIO OUT, HDMI IN 2 (ARC)	Fixed Sound (Volume MAX)	Fixed Sound (Volume MAX)



MUTE

Mutes the current sound output.

Press **MUTE**.

- "❌" will be displayed on the screen for 30 minutes.

NOTE

- Mute can be cancelled by pressing **VOL+/-** or **MUTE**.





FLASHBACK

Press  (**FLASHBACK**) to switch to the previously tuned channel or previous input mode.

- Press  (**FLASHBACK**) again to switch back to the currently tuned channel.

NOTE

-  (**FLASHBACK**) will not work if no channel has been changed after the TV is turned on.
- With  (**FLASHBACK**), only input from TV, HDMI 1 through 4, or Video will be stored in Memory.



AUDIO AD

Switching the digital audio format (DTV only)

If multi sound modes are received, each time you press **AUDIO AD** the mode switches.

NOTE

- The sound mode screen disappears in six seconds.
- Selectable items vary depending on the received broadcasts.
- The audio description sound is selected depending on the main audio.

Switching the analogue audio format

You can switch between multiple audio modes when watching a multiple audio or stereo broadcast programme.



In the NICAM TV broadcasts

When receiving a stereo signal

Each time you press **AUDIO AD**, the mode switches between Nicam Stereo and Mono.

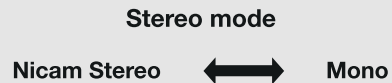

When receiving a bilingual signal

Each time you press **AUDIO AD**, the mode switches among Nicam Dual1, Nicam Dual2 and Mono.

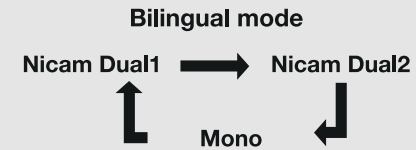

When receiving a monaural signal

Each time you press **AUDIO AD**, the mode switches between Nicam Mono and Mono.



In the TV mode of A2 TV broadcasts

When receiving a stereo signal

Each time you press **AUDIO AD**, the mode switches between Stereo and Mono.



When receiving a bilingual signal

Each time you press **AUDIO AD**, the mode switches among Dual1 and Dual2.

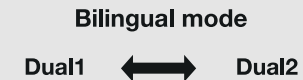

When receiving a monaural signal

When you press **AUDIO AD**, "Mono" displays.





Sleep Timer

Allows you to set a time when the TV automatically switches to standby.

Press **SLEEP**.

- The remaining time displays when the sleep timer has been set.
- Each time you press **SLEEP**, the remaining time switches as shown below.

Off → 30 min. → 60 min. → 90 min.
 ↻ 180 min. ← 150 min. ← 120 min. ←

- When set, the time automatically starts counting down.
- If you want to adjust the sleep timer, you can press **SLEEP** twice then change the time setting.
- When it is 5 minutes before the time expires, the remaining time will start to keep appearing every minute.

NOTE

- Select "Off" by pressing **SLEEP** to cancel the sleep timer.
- The TV will enter standby when the remaining time reaches 0.



VIEW MODE

You can select the screen size.

1 Press **VIEW**.

- View Mode selection displayed.

2 Press **▲ / ▼** to select the View Mode and then press **● (ENTER)**.

For HD programmes

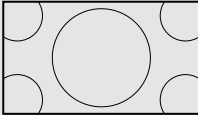
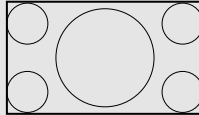
Full	Underscan
 <p>Displays with an overscan image. Crops all sides of screen.</p>	 <p>Displays an image with the same number of pixels on the screen when receiving HD signals only.</p>



NOTE



- When using Underscan, it is possible to see noise or bars around different outer portions of the screen. Please change view mode to correct this.
- This feature is available with TV, HDMI IN 1-4, and Video input. Availability in other input modes varies according to the individual App specifications.
- Some items do not appear depending on the type of received signal.

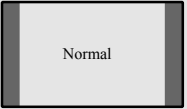

VIEW MODE (Continue)

For 4:3 programmes
Example: Screen size images

Normal	Full	Cinema 16:9
 <p data-bbox="936 427 990 446">Normal</p> <p data-bbox="795 534 1137 577">Keeps the original aspect ratio in a full screen display.</p>	 <p data-bbox="1348 427 1384 446">Full</p> <p data-bbox="1243 534 1482 553">For 16:9 squeeze pictures.</p>	 <p data-bbox="1713 443 1818 462">Cinema 16:9</p> <p data-bbox="1585 561 1944 630">For 16:9 letterbox pictures. Bars may appear on the top and bottom with some programmes.</p>

Cinema 14:9	Zoom 14:9
 <p data-bbox="922 817 1019 836">Cinema 14:9</p> <p data-bbox="788 938 1153 1007">For 14:9 letterbox pictures. Bars may appear on the top and bottom with some programmes.</p>	 <p data-bbox="1326 817 1406 836">Zoom 14:9</p> <p data-bbox="1176 938 1550 1023">For 14:9 letterbox pictures. A thin side bar appears on each side, and you may also see bars on the top and bottom with some programmes.</p>



VIEW MODE (Continue)

For PC
 Example: Screen size images

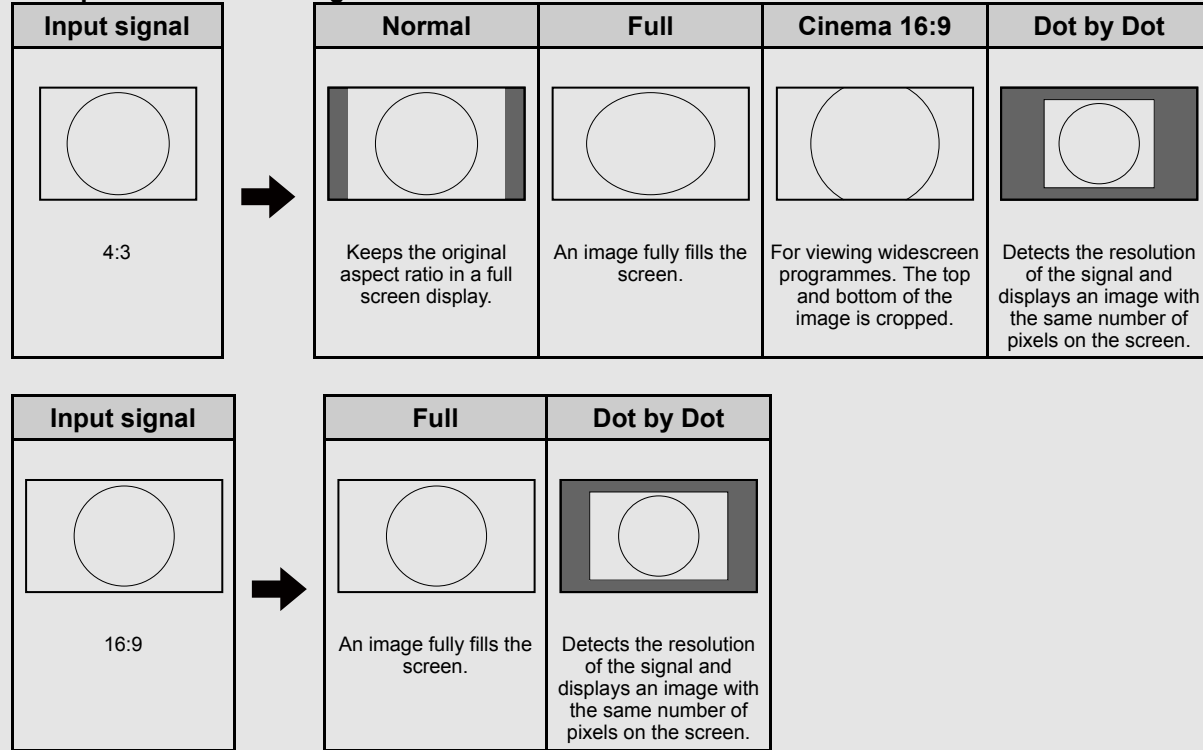

NOTE

- Connect the PC before making adjustments. See the Setup Guide.
- Selectable screen size may vary with input signal type.



NETFLIX

Displays the NETFLIX screen.

Press **NETFLIX**.

NOTE

- If you press the **NETFLIX** button when the TV is turned off, the TV turns on and the NETFLIX screen is displayed.
- To enjoy Netflix, you need to make:
 - a broadband Internet connection
([See page 9-1.](#))
 - settings of Internet Setup
([See page 9-1.](#))



YouTube

Displays the YouTube screen.

Press **YouTube**.

NOTE

- If you press the **YouTube** button when the TV is turned off, the TV turns on and the YouTube screen is displayed.
- To enjoy YouTube, you need to make:
 - a broadband Internet connection
([See page 9-1.](#))
 - settings of Internet Setup
([See page 9-1.](#))

Preparation

You can connect the TV to a USB memory device, USB hard drive, Home Network server to enjoy viewing pictures, listening to music, and watching videos.

NOTE

- Depending on the USB memory device/USB hard drive/Home Network server, the TV may not be able to recognise the recorded data.
- It may take time to read the recorded data if the USB memory device/USB hard drive/Home Network server contains many files or folders.
- Use only alphanumeric characters for naming files.
- File names over 80 characters (may vary depending on character set) may not be displayed.

Connecting a USB Memory Device/USB Hard Drive

Insert the USB memory device with recorded photos, music or videos into the USB 1 or USB 2 terminal on the TV.

- If USB memory devices are inserted into multiple terminals, the USB 1 terminal has priority.

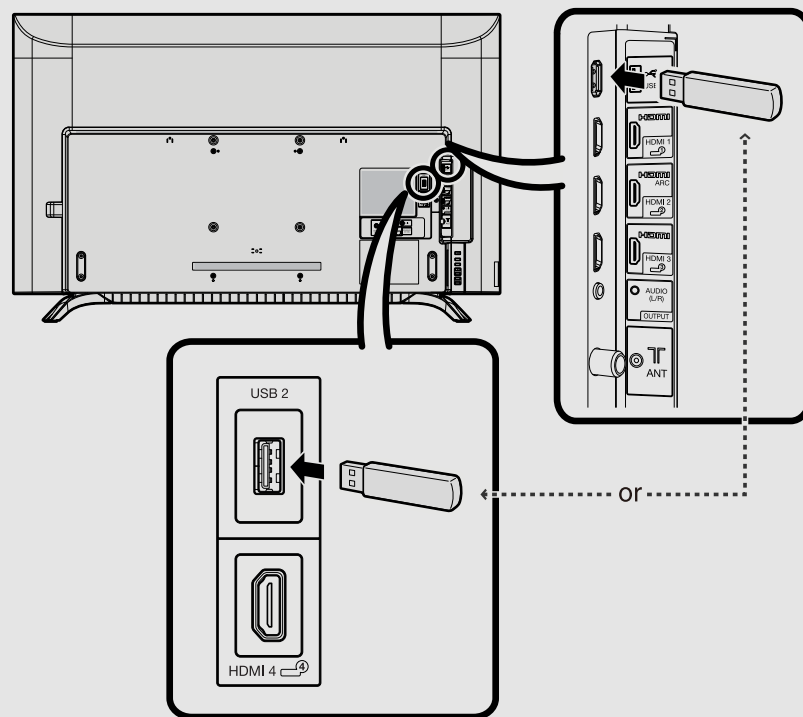

Preparation (Continue)

- When connecting a USB hard drive, be sure to use a hard drive with an AC adapter.
- Do not remove a USB memory device from the TV while transferring files, using the slide show function, or switching screens, or before you exit "Content Player".
- Do not insert and remove a USB memory device/USB hard drive to and from the TV repeatedly.
- When using a card reader, be sure to insert a USB memory device first.

CAUTION

- **Do not use a USB extension cable when connecting a USB memory device to the USB terminal on the TV.**
- **Using a USB extension cable with the USB memory device may prevent the TV from performing correctly.**

Connecting a Home Network Server

Connect the TV to the Home Network server using an ETHERNET cable.

- You can also connect a Home Network server by using a wireless LAN.

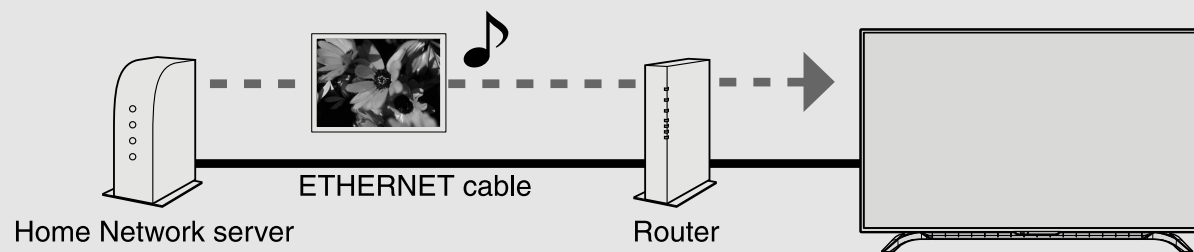

NOTE

- Do not disconnect a Home Network server from the TV while transferring files, when a screen is switching to another or before you exit "Content Player".
- Do not connect and disconnect a Home Network server from the TV repeatedly.

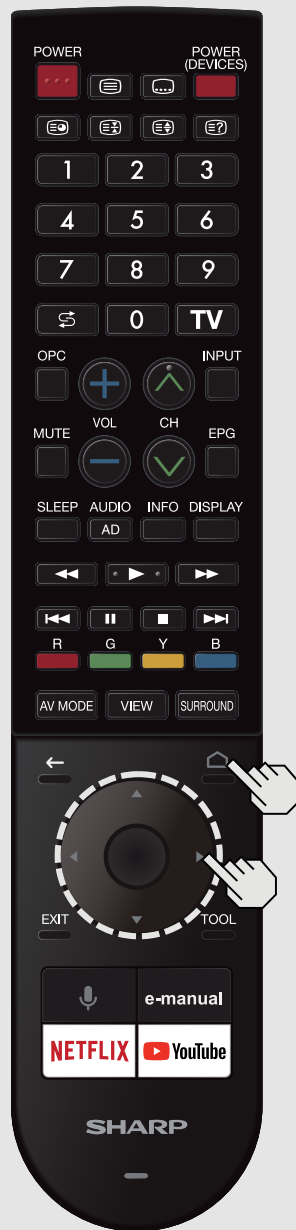

Selecting the Folders to Play Back

- To play back data on a USB memory device insert the USB memory device on the TV.
- 1 Select "Open Contents Player" from the Devices screen, or launch the Content Player app from HOME screen.
- 2 Press ◀/▶ to select "Music", "Video" or "Photo", and then press ● (ENTER).

Example

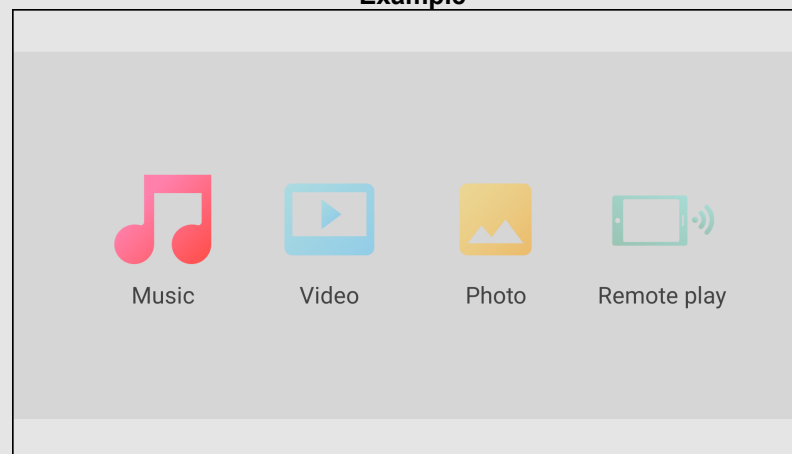

- 3 Press ▲/▼ (or ◀/▶) to select the drive/server where you want to find your file, and then press ● (ENTER).
- 4 Press ◀/▶ to select the desired folder, and then press ● (ENTER).

NOTE

- USB only support device up to DC5V 1.2A.

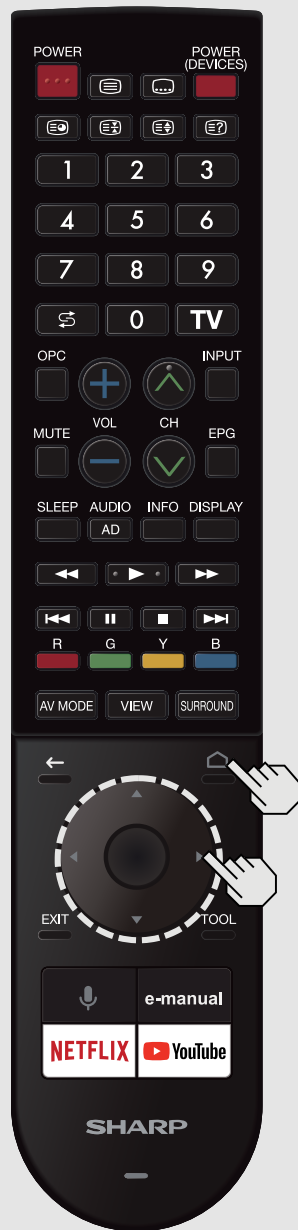

Selecting the Folders to Play Back (Continue)

NOTE

- If the TV is turned off and then on again, the number assigned to the USB may change.

USB Device Compatibility

USB device	USB Memory, USB card reader (Mass Storage class), USB hard drive
File system	FAT/FAT32

Photo file format

Format	JPEG, PNG, BMP
--------	----------------

Music file format

Format	Sampling rate [KHz]	Bitrate [Kbps]
MP3	8/11.025/12/16/22.050/24/32/44.1/48	8~320
AAC	32/44.1/48	8~320
WMA	8/11.025/16/22.05/32/44.1/48/64/88.2/96	8~384
WAV	8/11.025/12/16/22.050/24/32/44.1/48	8~1024

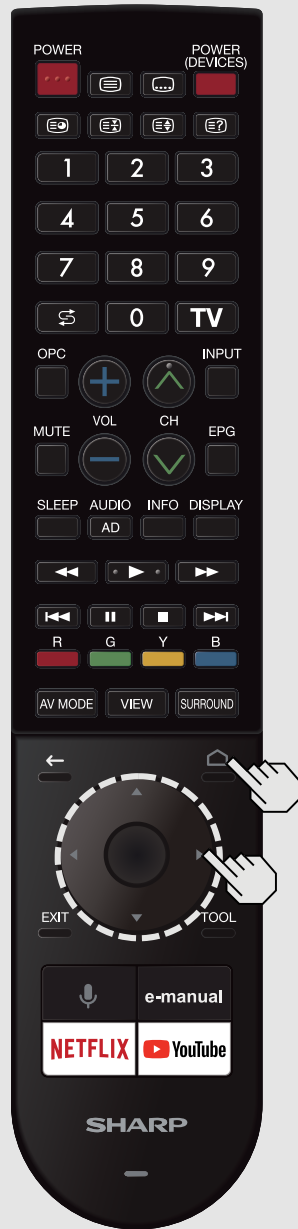

Selecting the Folders to Play Back (Continue)

Video file format

Container	Video	Audio
AVI	MPEG-1 MPEG-2 MPEG-4 H.264	PCM MP2: MPEG-1 Layer2 MP3: MPEG-1 Layer3 AAC AC3 WMA
MKV	MPEG-1 MPEG-2 MPEG-4 H.264 VP8 H.265(HEVC)	PCM MP2: MPEG-1 Layer2 MP3: MPEG-1 Layer3 AAC AC3 WMA VORBIS
ASF	MPEG-4 VC1(WMV3)	MP3: MPEG-1 Layer3 WMA
PS	MPEG-1 MPEG-2	MP2: MPEG-1 Layer2 MP3: MPEG-1 Layer3 AC3
TS	MPEG-2 VC1(WMV3) H.264 H.265(HEVC)	MP2: MPEG-1 Layer2 AAC AC3
MP4	MPEG-4 H.264 H.265(HEVC) VP8 VC1(WMV3)	MP2: MPEG-1 Layer2 MP3: MPEG-1 Layer3 AAC

NOTE

- Progressive format jpeg files are not supported.
- USB 1.1 devices may not be played properly.
- Operation using USB hubs is not guaranteed.
- Some video file formats may not be played depending on the file.
- Some images may not be displayed in the appropriate aspect ratio depending on the file format.
- File extensions are not used to determine the file format.

Home Network Server Compatibility

Photo file format	JPEG
Music file format	WAV, MP3
Video file format	MPEG2-PS, MPEG2-TS, WMV, ASF, MP4, MOV, AVI

NOTE

- Progressive format jpeg files are not supported.
- Some video file formats may not be played depending on the file or the server.



Playing Back Files on a USB Memory Device/Home Network Server

Photo Mode

Viewing Thumbnails

Example

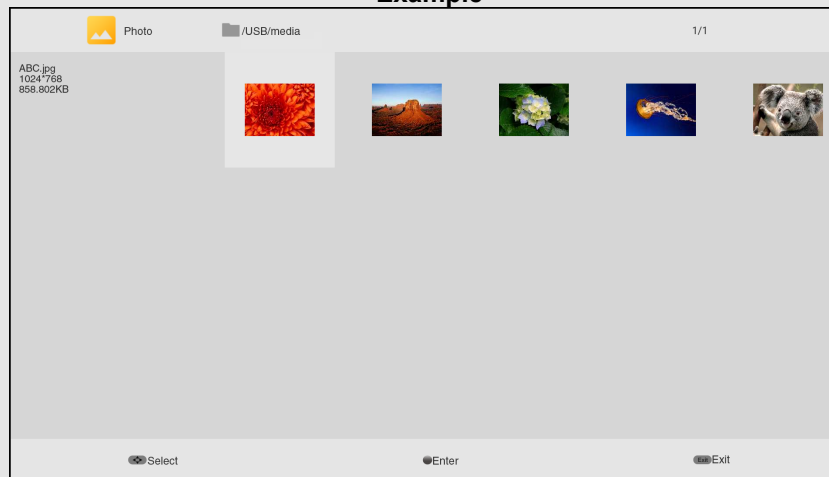

Buttons for thumbnail/list operations

Buttons	Description
▲ / ▼	Select a desired item.
◀	In Thumbnail mode: Select a desired item. In List mode: Return to the previous process.
▶	In Thumbnail mode: Select a desired item. In List mode, when selecting a folder icon: Enter this directory. In List mode, when selecting a photo file: Enlarge the photo.
● (ENTER)	When selecting a folder icon: Enter this directory. When selecting a photo file: Enlarge the photo.
◀ (Back)	In Thumbnail mode: Return to the previous process. In List mode: Exit application.
B (blue)	Change Thumbnail/List mode.
Y (yellow)	Display the Menu screen.



Playing Back Files on a USB Memory Device/Home Network Server (Continue)

Menu for thumbnail operations

Press ▲ / ▼ to select an item and make settings to your preferences.

Example

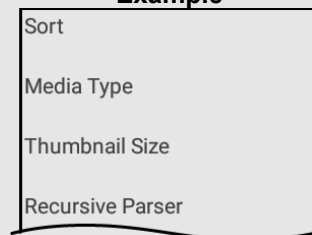

Sort

You can change the way in which files are ordered.

Press ▲ / ▼ to select "Type", "Date" or "Name", and then press ● (ENTER).

Media Type

Switch the media type when the Recursive Parser display is displayed.

Thumbnail Size

Change the thumbnail size.

Small/Medium/Large

Recursive Parser

Display all files according to the Media Type settings.

NOTE

- You can see the file name, file size and pixel size of the selected photo in the upper-left corner of the screen.
- When you are viewing the Content Player app, you cannot configure Picture/Audio settings.



Playing Back Files on a USB Memory Device/Home Network Server (Continue)

Slide Show

The photos displayed on the thumbnail selection screen are displayed as a slide show.

Buttons for slide show operation

Buttons	Description
▶	Play the Slide Show.
⏸	Pause the Slide Show.
▲ / ▼ / ◀ / ▶, ● (ENTER)	Select the desired item.
◀ (Back)	Return to the thumbnail selection screen.
Y (yellow)	Display the USB Menu screen.

Menu for slide show

Example

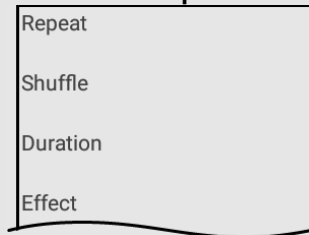

Repeat

Set whether to show the slide show repeatedly.
None/Repeat One/Repeat All

Shuffle

Shuffle the image files within the folder and display as a slide show.

Duration

Specify the length of time before the next image appears.
Press ▲ / ▼ to select the desired length of the time, and then press ● (ENTER).

Short/Medium/Long

Effect

Specify the effect for transitioning to the next image.

**None/Dissolve/Wipe right/Wipe left/Wipe up/Wipe down
Box in/Box out/Random**

Rotate*

Rotate the photo by 90 degrees to the right.
* Only displayed when playback is paused.

Zoom*

Zoom in on the image.
Normal/Zoom1/Zoom2
* Only displayed when playback is paused.

Sort

You can change the way in which files are ordered.
Press ▲ / ▼ to select "Type", "Date" or "Name", and then press ● (ENTER).

NOTE

- The slide show continues until you press ◀ (Back).
- For setting the slide show speed, select "Duration" on the Menu screen.

Playing Back Files on a USB Memory Device/Home Network Server (Continue)

Music Mode

Viewing Thumbnails

Example

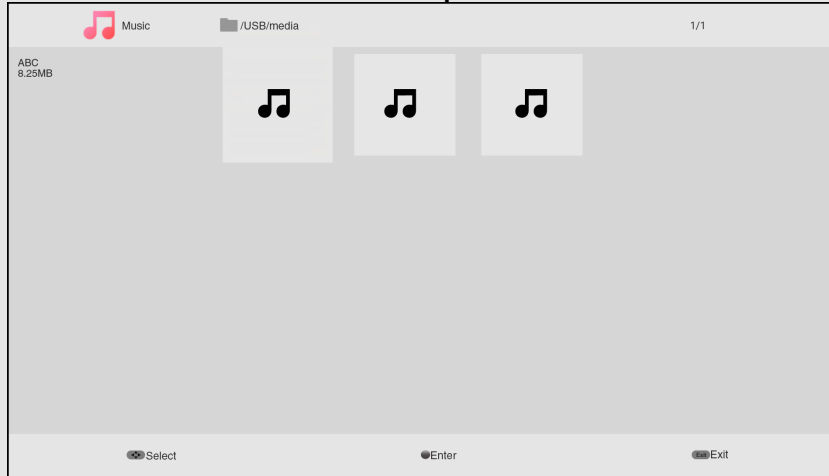

Buttons for thumbnail/list operations

Buttons	Description
▲ / ▼	Select a desired item.
◀	In Thumbnail mode: Select a desired item. In List mode. Return to the previous process.
▶	In Thumbnail mode: Select a desired item. In List mode, when selecting a folder icon: Enter this directory. In List mode, when selecting a music file: Play music.
● (ENTER)	When selecting a folder icon: Enter this directory. When selecting a music file: Play music.
◀ (Back)	In Thumbnail mode: Return to the previous process. In List mode. Exit application.
B (blue)	Change Thumbnail/List mode.
Y (yellow)	Display the MENU screen.

NOTE

- When you are viewing the Content Player app, you cannot configure Picture/Audio settings.

Playing Back Files on a USB Memory Device/Home Network Server (Continue)

Menu for thumbnail operations

Example

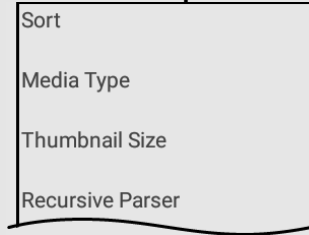

Sort

You can change the way in which files are ordered.
Press ▲ / ▼ to select "Date", "Genre", "Artist" or "Album", and then press ● (ENTER).

Media Type

Switch the media type when the Recursive Parser display is displayed.

Thumbnail Size

Change the thumbnail size.

Small/Medium/Large

Recursive Parser

Display all files according to the Media Type settings.



Playing Back Files on a USB Memory Device/Home Network Server (Continue)

Playing Mode

Buttons for playing mode

Buttons	Description
◀◀	The fast reverse speed changes every time you press ◀◀.
▶▶	The fast forward speed changes every time you press ▶▶.
⏸	Pause the music.
◀◀	Go to the previous file.
▶▶	Go to the next file.
▲/▼/◀/▶, ● (ENTER)	Select a desired item.
◀ (Back)	Return to the previous process.
Y (yellow)	Display the Menu screen.

NOTE

- The displayed play time may differ slightly from the actual play time depending on the files.

Menu for playing mode

Example

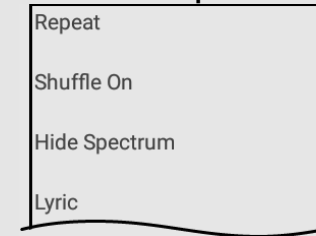

Repeat

Configure the repeat playback settings.

None/Repeat One/Repeat All

Shuffle

Shuffle the music within the folder.

Hide Spectrum/Show Spectrum

Show or hide the spectrum.

Lyric

You can change the lyric display type.

This is only available when a lyrics file (".lrc") is present.

Only UTF-8 character code lyric files (without BOM) are supported.



Playing Back Files on a USB Memory Device/Home Network Server (Continue)

Video Mode

Viewing Thumbnails

Example

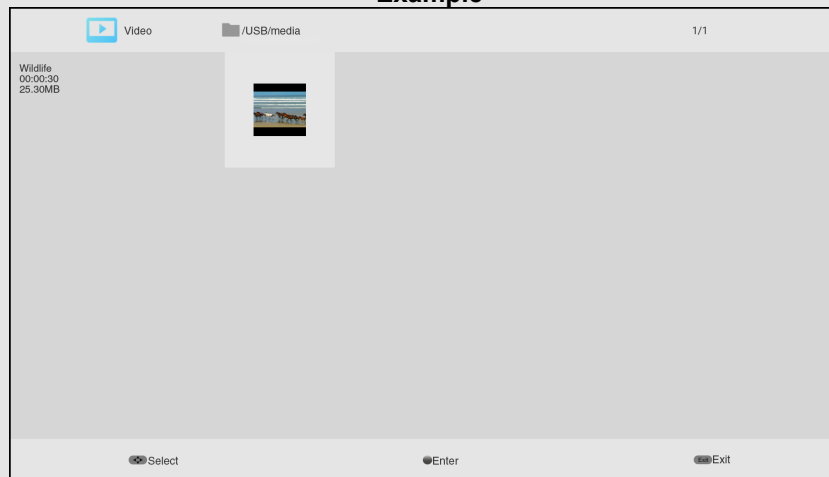

Buttons for thumbnail/list operations

Buttons	Description
▲ / ▼	Select a desired item.
◀	In Thumbnail mode: Select a desired item. In List mode: Return to the previous process.
▶	In Thumbnail mode: Select a desired item. In List mode, when selecting a folder icon: Enter this directory. In List mode, when selecting a video file: Play the video file.
● (ENTER)	When selecting a folder icon: Enter this directory. When selecting a video file: Play the video file.
◀ (Back)	In Thumbnail mode: Return to the previous process. In List mode: Exit application.
B (blue)	Change Thumbnail/List mode.
Y (yellow)	Display the Menu screen.

Playing Back Files on a USB Memory Device/Home Network Server (Continue)

Menu for thumbnail operations

Example

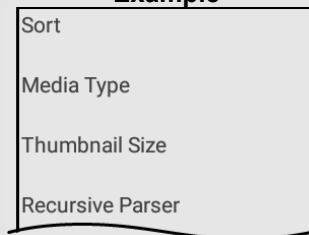

Sort

You can change the way in which files are ordered.
Press ▲ / ▼ to select "Type", "Date" or "Name", and then press ● (ENTER).

Media Type

Switch the media type when the Recursive Parser display is displayed.

Thumbnail Size

Change the thumbnail size.
Small/Medium/Large

Recursive Parser

Display all files according to the Media Type settings.

NOTE

- When you are viewing the Content Player app, you cannot configure Picture/Audio settings.



Playing Back Files on a USB Memory Device/Home Network Server (Continue)

Playing Mode

Buttons for playing mode

Buttons	Description
◀◀	The fast reverse speed changes every time you press ◀◀.
▶	Play the video
▶▶	The fast forward speed changes every time you press ▶▶.
⏸	Pause the video.
◀◀◀	Go to the previous file.
■	Stop the video.
▶▶▶	Go to the next file.
▲ / ▼ / ◀ / ▶, (ENTER)	Select a desired item.
◀ (Back)	Return to the previous process.
Y (yellow)	Display the Menu screen.

Menu for playing mode

Example

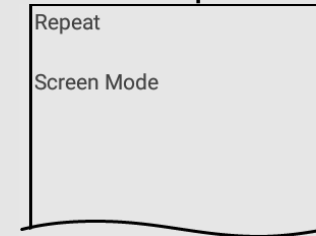

Repeat

Configure the repeat playback settings.

None/Repeat One/Repeat All

Screen Mode

Set the screen size.

Auto/Original

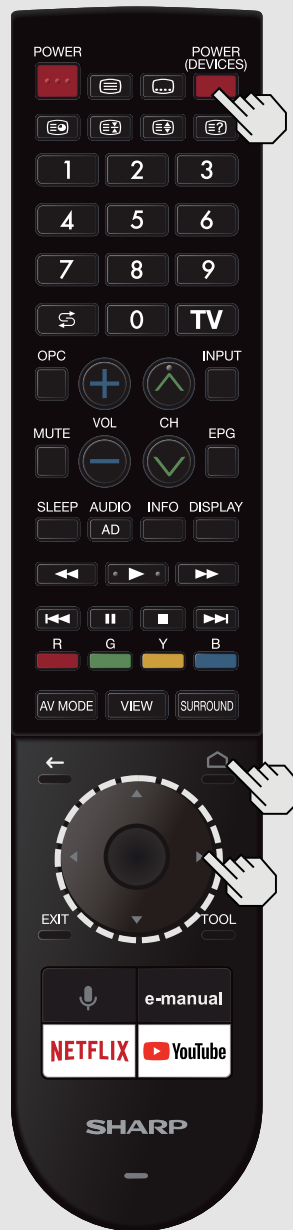

Playing Back Files from a Portable Device

With the remote playback function, you can use your portable device to play back pictures, video, and music on the Home Network server.

Preparation

Use Wi-Fi to connect the smartphone or tablet to the TV.

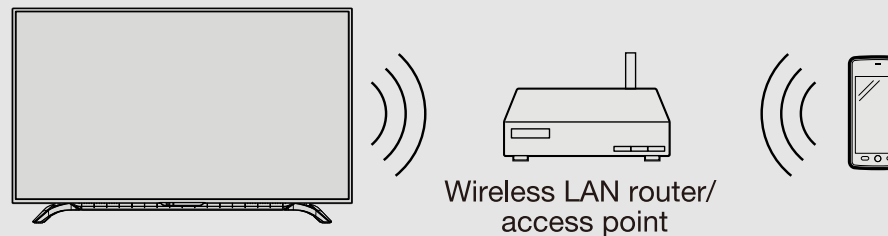

NOTE

- A wireless access point is required to use a portable device.



Playing Back Files from a Portable Device (Continue)

- 1 Select "Open Contents Player" from the Devices screen, or launch the Content Player app from HOME screen.
- 2 Press ◀/▶ to select "Remote play" icon, and then ● (ENTER).

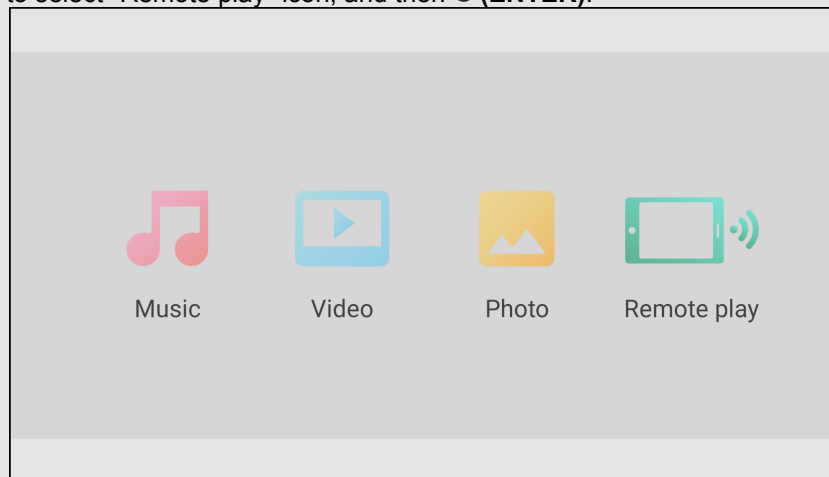

- 3 While the TV is in standby mode, send photos/music/video from the smartphone, tablet, or similar device to the TV.
- To use the remote playback function, your portable device must be a DLNA Certified Digital Media Controller.

NOTE

- This function will only start when the standby screen of Remote play is displayed after you launch the Content Player app from the HOME screen.
- This function may not work while an Internet application is being used.
- For information on the compatible formats, see "Home Network Server Compatibility" on [page 6-5](#).
- Some Digital Media Controllers and Remote play applications are not supported. In this situation, regardless of whether the file can be played back, the message "Playback not possible" may be displayed, and playback may be stopped.

Controlling HDMI Equipment Using LINK Operation

What's LINK Operation?

- Using the HDMI CEC (Consumer Electronics Control) protocol, with LINK Operation you can interactively operate compatible system equipment (Blu-ray disc equipment, AV amplifier, DVD).
- By connecting LINK-compatible devices with HDMI-certified cables to the TV, you can control a recorder or AV amplifier using the remote control of the TV.
- LINK Operation allows you to operate the HDMI-connected equipment with one remote control.

NOTE

- HDMI IN 1 and 2 terminals are all capable of receiving 4K60P 4:4:4 signals.
To receive 4K60P 4:4:4 signals, on the Devices menu, set the HDMI type to "Full". ([See page 4-9](#))
- For connecting the TV to LINK-compatible equipment, use commercially available cables.
- Point the remote control toward the TV, not to connected HDMI equipment.
- Video noise may occur depending on the type of HDMI cable used. Make sure to use an HDMI-certified cable.
- Up to 3 pieces of HDMI recording equipment and one AV amplifier can be connected using this system.

NOTE

- If the equipment does not operate, turn on the equipment and select the appropriate input source using **POWER (DEVICES)**.
- The LINK feature may not operate properly when an HDMI splitter or AV selector unit is used. These devices may cause interruptions to the image and/or sound.

Connected LINK-compatible devices can be operated without changing the settings of the remote control unit.

One Touch Play

While the TV is in standby mode, it automatically turns on and plays back the image from the HDMI source.

Single remote control

The LINK Operation automatically recognizes the connected HDMI device and you can control the TV and the devices as if using a universal remote control.

Control the LINK-compatible audio system

Set the volume of LINK-compatible audio system.

NOTE

- The above description is an example of the LINK Operation function.
- Refer to this operation manual and the operation manual of the LINK-compatible device to be used with this TV.

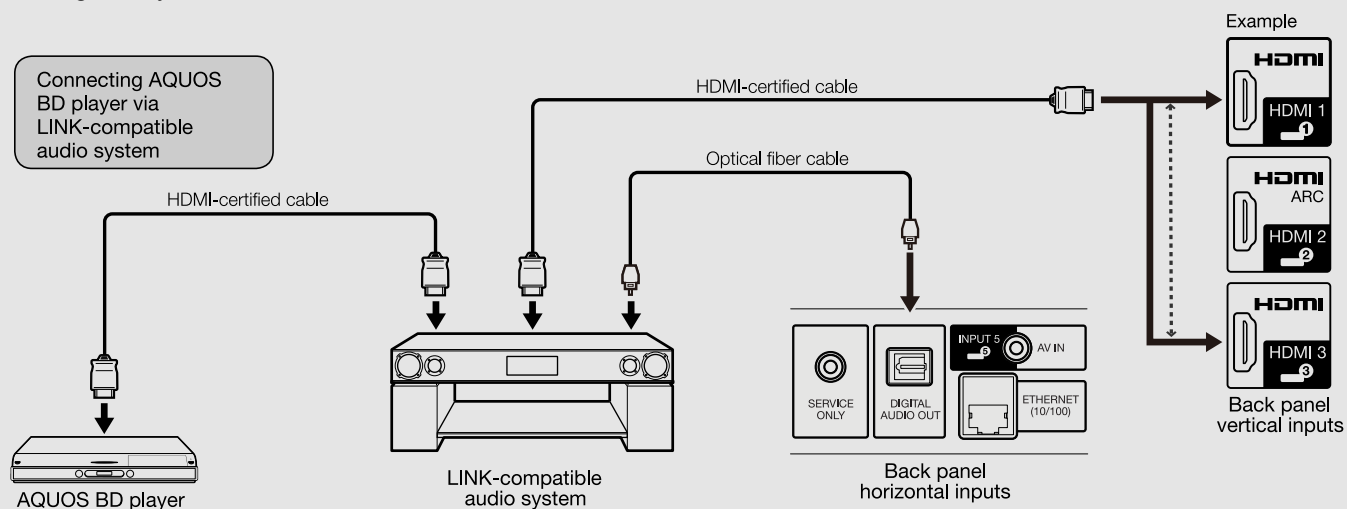

EN 7-1

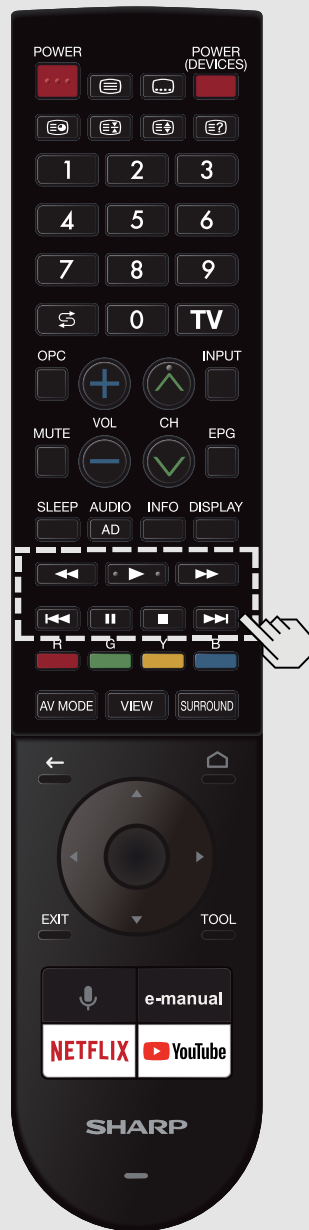

Controlling HDMI Equipment Using LINK Operation (Continue)

One Touch Playback

LINK Operation allows you to operate the HDMI-connected equipment with one remote control.

Press ► to start playing back a title.

- The last played programme is played back. You can use the following buttons during broadcast viewing.

Buttons	Description
◀◀	Hold down this button to go in reverse.
▶	Starts playback.
▶▶	Hold down this button to fast forward.
■	Stops playback.
⏸	Sets pauses and still pictures.
⏮	Pressing quickly once takes you to the start of the chapter currently playing. Each time you press it, you move back to the start of the previous chapter.
⏭	Pressing quickly once takes you to the start of the next chapter. Each time you press it, you move ahead to the start of the next chapter.

Setting Audio Input

Audio Select HDMI

This function sets the terminal to output the computer audio. The adjustment items vary depending on the input source. Select the input source corresponding to the terminal connected to the PC and then adjust the desired item.

To perform the operation, refer to "HOME" > "Settings" > "TV" > "Input/Output" > "Audio Select HDMI".

HDMI 3

HDMI: Select this when the TV and PC are connected using an HDMI-certified cable and audio is input via the same cable.

HDMI+AV Input: Select this when the TV and PC are connected using a HDMI-certified cable and the audio is input via a Ø 3.5 mm stereo minijack.

NOTE

- When "Audio Select HDMI" is set to "HDMI+AV Input", sound will not be produced if you use only an HDMI-certified cable to connect HDMI-compatible equipment. To produce sound, you should make an analogue audio connection.
- If you want to connect HDMI-compatible equipment using only an HDMI-certified cable, set "Audio Select HDMI" to "HDMI".
- "Audio Select HDMI" can only be set for the HDMI IN 3.

Connecting to the Internet

By connecting your TV to a broadband system, you can access the Internet from the TV.

- You can enjoy a variety of streaming content and Internet applications.
- It is necessary to configure the network settings in order to enjoy streaming content and internet applications. These settings can be configured from "HOME" > "Settings" > "Network & Peripherals" > "Network".

NOTE

- To connect your TV to the Internet, you must have a broadband Internet connection.
- If you do not have a broadband Internet connection, consult the store where you purchased your TV or ask your Internet service provider or telephone company.
- When an Internet connection is made, an Ethernet and wireless connection cannot be used at the same time. Use only one of the connection types.

Using an ETHERNET cable

Use an ETHERNET cable (commercially available) to connect the ETHERNET terminal on the TV to your broadband router (commercially available).

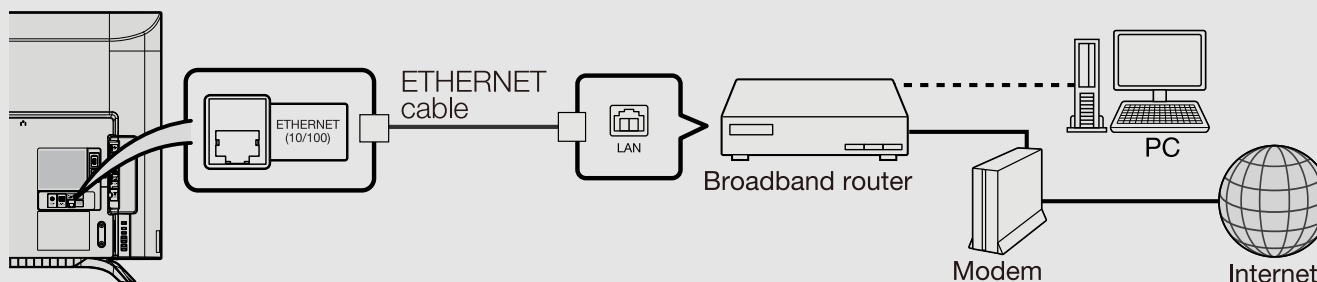

Using the wireless LAN

This TV is equipped with a wireless LAN function.

For a wireless LAN connection, you must use wireless setup to connect the access point and TV.



Connecting to the Internet (Continue)

NOTE

- This TV has a built-in wireless LAN function. Using a separate wireless USB LAN adapter may result in radio communications that do not comply with regulations on radio communications. Therefore, do not use a separate wireless LAN adapter.
- A wireless LAN connection and performance cannot be guaranteed for all residential environments. In the following cases, the wireless LAN signal may be poor or drop, or the connection speed may become slower.
 - When used in buildings made with concrete, reinforced steel, or metal
 - When placed near objects that obstruct the signal
 - When used with other wireless devices that emit the same frequency
 - When used in the vicinity of microwave ovens and other devices that emit a magnetic field, electrostatic charge, or electromagnetic interference
- When there is significant interference in the 2.4-GHz frequency (such as from other wireless LAN devices, Bluetooth® devices, 2.4-GHz cordless telephones, and microwave ovens), it is recommended that you use a wireless LAN router/access point that supports IEEE802.11ac (5 GHz) and set the access point to transmit at 5 GHz. For setup details, see the operation manual of your access point.
- Operations cannot be guaranteed when used with access points that do not have Wi-Fi® certification.
- A wireless LAN router/access point is required to connect the TV to the Internet using a wireless LAN. See the operation manual of your access point for setup.
- If your access point is set to a stealth mode (that prevents detection by other devices), you may not be able to establish a connection. In this case, disable the stealth mode on the access point.
- A stable connection speed is required to play back streaming content. Use an Ethernet connection if the wireless LAN speed is unstable.
- Before transferring to a third party or disposal, be sure to initialize the wireless LAN settings.
- Please follow the legislation in your country when using the wireless LAN outdoors.
- If you have failed to connect to the Internet in the above operation, then an error message will appear. In this case, press **EXIT** to exit from the connected TV feature to make changes to the network settings.
- If you still cannot connect to the Internet, please consult your Internet service provider or telephone company.
- You cannot configure the settings from "HOME" > "Settings" > "Network & Peripherals" > "Network" while using an application. If you must configure your "Network" settings, press the **EXIT** key to exit the function.



Using Keyboard and Mouse

You can use a keyboard or mouse for operating the TV when using applications.

- When you use the USB devices, connect the device to the USB terminal on the TV.
- When you use the bluetooth device, make necessary settings with "Bluetooth".

NOTE

- The keyboard or mouse may not operate properly depending on the application being used.
- The bluetooth device may not operate properly depending on the device being used.

Notes

DISCLAIMERS

- This SHARP device facilitates the access to content and services provided by third parties. The content and services accessible via this device belong to and may be proprietary to third parties. Therefore, any use of such third party content and services must be in accordance with any authorization or terms of use provided by such content or service provider. SHARP shall not be liable to you or any third party for your failure to abide by such authorization or terms of use. Unless otherwise specifically authorized by the applicable content or service provider, all third party content and services provided are for personal and non-commercial use; you may not modify, copy, distribute, transmit, display, perform, reproduce, upload, publish, license, create derivative works from, transfer or sell in any manner or medium any content or services available via this device.
- SHARP is not responsible, nor liable, for customer service-related issues related to the third party content or services. Any questions, comments or service-related inquiries relating to the third party content or service should be made directly to the applicable content or service provider. You may not be able to access content or services from the device for a variety of reasons which may be unrelated to the device itself, including, but not limited to, power failure, other Internet connection, or failure to configure your device properly. SHARP, its directors, officers, employees, agents, contractors and affiliates shall not be liable to you or any third party with respect to such failures or maintenance outages, regardless of cause or whether or not it could have been avoided.
- ALL THIRD PARTY CONTENT OR SERVICES ACCESSIBLE VIA THIS DEVICE IS PROVIDED TO YOU ON AN "AS-IS" AND "AS AVAILABLE" BASIS AND SHARP AND ITS AFFILIATES MAKE NO WARRANTY OR REPRESENTATION OF ANY KIND TO YOU, EITHER EXPRESS OR IMPLIED, INCLUDING, WITHOUT LIMITATION, ANY WARRANTIES OF MERCHANTABILITY, NON-INFRINGEMENT, FITNESS FOR A PARTICULAR PURPOSE OR ANY WARRANTIES OF SUITABILITY, AVAILABILITY, ACCURACY, COMPLETENESS, SECURITY, TITLE, USEFULNESS, LACK OF NEGLIGENCE OR ERROR-FREE OR UNINTERRUPTED OPERATION OR USE OF THE CONTENT OR SERVICES PROVIDED TO YOU OR THAT THE CONTENT OR SERVICES WILL MEET YOUR REQUIREMENTS OR EXPECTATIONS.
- SHARP IS NOT AN AGENT OF AND ASSUMES NO RESPONSIBILITY FOR THE ACTS OR OMISSIONS OF THIRD PARTY CONTENT OR SERVICE PROVIDERS, NOR ANY ASPECT OF THE CONTENT OR SERVICE RELATED TO SUCH THIRD PARTY PROVIDERS.
- IN NO EVENT WILL SHARP AND/OR ITS AFFILIATES BE LIABLE TO YOU OR ANY THIRD PARTY FOR ANY DIRECT, INDIRECT, SPECIAL, INCIDENTAL, PUNITIVE, CONSEQUENTIAL OR OTHER DAMAGES, WHETHER THE THEORY OF LIABILITY IS BASED ON CONTRACT, TORT, NEGLIGENCE, BREACH OF WARRANTY, STRICT LIABILITY OR OTHERWISE AND WHETHER OR NOT SHARP AND/OR ITS AFFILIATES HAVE BEEN ADVISED OF THE POSSIBILITY OF SUCH DAMAGES.

Troubleshooting

Problem	Possible Solution
<ul style="list-style-type: none"> No power 	<ul style="list-style-type: none"> Check if you pressed POWER on the remote control unit. Is the AC cord disconnected? Has the power been turned on?
<ul style="list-style-type: none"> Unit cannot be operated. 	<ul style="list-style-type: none"> External influences such as lightning, static electricity, may cause improper operation. In this case, operate the unit after first turning off the power of the TV or unplugging the AC cord and replugging it in after 1 or 2 minutes.
<ul style="list-style-type: none"> Remote control unit does not operate. 	<ul style="list-style-type: none"> Is the equipment to be operated by the remote control unit set correctly? Press TV to set the remote control unit to the setting for operating the TV. Are batteries inserted with polarity (+, -) aligned? Are batteries worn out? (Replace with new batteries.) Are you using it under strong or fluorescent lighting? Is a fluorescent light illuminated near the remote control sensor?
<ul style="list-style-type: none"> Picture is cut off/with sidebar screen. 	<ul style="list-style-type: none"> Are screen mode adjustments such as picture size made correctly? Pages 5-7 to 5-9
<ul style="list-style-type: none"> Strange colour, light colour, or colour misalignment 	<ul style="list-style-type: none"> Adjust the picture tone. Pages 3-3 to 3-21 Is the room too bright? The picture may look dark in a room that is too bright.
<ul style="list-style-type: none"> Power is suddenly turned off. 	<ul style="list-style-type: none"> Is the sleep timer set? Page 5-6 Check the power control settings. Pages 4-26 to 4-28 The unit's internal temperature has increased. Remove any objects blocking vent or clean.

Problem	Possible Solution
<ul style="list-style-type: none"> No picture 	<ul style="list-style-type: none"> Is connection to other components correct? If the PC image is not displayed, check the following: <ul style="list-style-type: none"> When connecting a laptop PC to the TV, check that display output mode of the PC is set to external monitor. For 4K60P signals applied to an HDMI input, the external device may not be outputting signals correctly. Set "HDMI Type Selection" to "Limited". Page 4-9
<ul style="list-style-type: none"> Picture quality of HD programmes is poor. 	<ul style="list-style-type: none"> To enjoy HD images from external equipment, you are required to set up HDMI connection or component connection. If the programme content is not of HD quality, HD images cannot be displayed. Check that the programme you are viewing provides HD images. The HD cable/satellite set-top box may need to be configured to output HD images via cable/satellite. The cable/satellite broadcast may not support a signal resolution of 1080p.
<ul style="list-style-type: none"> The TV sometimes makes a cracking sound. 	<ul style="list-style-type: none"> This is not a malfunction. This happens when the cabinet slightly expands and contracts according to change in temperature. This does not affect the TV's performance.

Troubleshooting (Continue)

Problem	Possible Solution
<ul style="list-style-type: none"> No sound 	<ul style="list-style-type: none"> Is connection to other components correct? Is the volume too low? Page 5-2 Is "Variable" selected in "Audio Out"? Page 4-10 Have you pressed MUTE on the remote control unit? Page 5-3 Check the audio output of the connected external equipment. Is the volume too low or muted? When external equipment is connected via an HDMI cable, you may need to configure the audio to be output through the HDMI cable. When audio is not output from external equipment connected to the HDMI IN 3 terminal, check the "Audio Select HDMI" setting. Page 8-1 Even when external equipment is connected using an HDMI-certified cable, an audio cable connection may be required depending on the type of equipment and the media being played back. In this case, in addition to connecting an HDMI-certified cable to the HDMI IN 3 terminal, connect a Ø 3.5 mm stereo minijack cable to the AUDIO IN terminal and set "Audio Select HDMI" to "HDMI+AV Input". Page 8-1 When connecting a PC via an HDMI-certified cable, check the following: <ul style="list-style-type: none"> - Is the audio output of the PC configured correctly? Check the audio output settings and output audio format in Sound Properties on the PC. The audio formats compatible with this TV are PCM, Dolby Digital. With other formats, audio cannot be output. - Depending on the board, only video signals may be output. In this case, in addition to connecting an HDMI-certified cable to the HDMI IN 3 terminal, connect a Ø 3.5 mm stereo minijack cable to the AUDIO IN terminal and set "Audio Select HDMI" to "HDMI+AV Input". Page 8-1

Problem	Possible Solution
<ul style="list-style-type: none"> Chromecast built-in image/ audio cannot be output to the TV. 	<ul style="list-style-type: none"> Check pairing.
<ul style="list-style-type: none"> Software updates via Over-The-Air (OTA) is not successful. 	<ul style="list-style-type: none"> Make sure your internet connection is working. If the TV is connected to Internet, but no connection available, please disconnect the internet from your TV and then reconnect again.

Troubleshooting - Error Message

The example of an error message displayed on a screen	Possible Solution
<ul style="list-style-type: none">No broadcast now.	<ul style="list-style-type: none">Check the antenna cable. Check that the antenna is correctly setup.Check the broadcast time in the programme guide.
<ul style="list-style-type: none">An incompatible audio signal has been received. Check the output device settings.	<ul style="list-style-type: none">This message is displayed when an audio format other than PCM, Dolby Digital is input.<ul style="list-style-type: none">- Set the audio output format of connected external HDMI equipment to PCM, Dolby Digital.- Refer to the operation manual of the external equipment for setting details.

Information on the Software License for This Product

Software License

You can read the software licenses in the on-screen display menu. Refer to "HOME" > "Settings"> "TV" > "About" > "Legal information" > "Open source licenses".

Software composition

The software included in this product is comprised of various software components whose individual copyrights are held by SHARP or by third parties.

Cautions regarding use in high and low temperature environments

- When the unit is used in a low temperature space (e.g. room, office), the picture may leave trails or appear slightly delayed. This is not a malfunction, and the unit will recover when the temperature returns to normal.
- Do not leave the unit in a hot or cold location. Also, do not leave the unit in a location exposed to direct sunlight or near a heater, as this may cause the cabinet to deform and the front panel to malfunction.

Storage temperature: -20°C to +60°C

- Google, Android, Android TV, YouTube and other related marks and logos are trademarks of Google LLC.

- Manufactured under license from Dolby Laboratories. Dolby, Dolby Audio, and the double-D symbol are trademarks of Dolby Laboratories.

- The terms HDMI and HDMI High-Definition Multimedia Interface, and the HDMI Logo are trademarks or registered trademarks of HDMI Licensing Administrator, Inc. in the United States and other countries.

- The Wi-Fi CERTIFIED™ Logo is a certification mark of Wi-Fi Alliance®.
- The Wi-Fi Protected Setup™ Logo is a certification mark of Wi-Fi Alliance®.

- The Bluetooth® word mark and logos are registered trademarks owned by the Bluetooth SIG, Inc. and any use of such marks by SHARP Corporation is under license. Other trademarks and trade names are those of their respective owners.

- Manufactured under license from Eilex International, LLC. Eilex PRISM is a trademark of Eilex International, LLC. VIR Filter is a trademark of Eilex International, LLC.

Eilex Technology Description

- Eilex PRISM™ equalizes acoustic power volume density frequency response and corrects time and phase alignment errors of a speaker system. Speakers with Eilex PRISM perform as near-perfect electro-acoustic transducers providing true-to-original sound with the highest musicality and intelligibility.
- VIR Filter™ is high-performance filter developed for audio purposes.

- ANY USE OF THIS PRODUCT IN ANY MANNER OTHER THAN PERSONAL USE THAT COMPLIES WITH THE MPEG-2 STANDARD FOR ENCODING VIDEO INFORMATION FOR PACKAGED MEDIA IS EXPRESSLY PROHIBITED WITHOUT A LICENSE UNDER APPLICABLE PATENTS IN THE MPEG-2 PATENT PORTFOLIO, WHICH LICENSE IS AVAILABLE FROM MPEG LA, LLC, 6312 S. Fiddlers Green Circle, Suite 400 E, Greenwood Village, Colorado 80111 U.S.A.

- THIS PRODUCT IS LICENSED UNDER THE VC-1 PATENT PORTFOLIO LICENSE FOR THE PERSONAL AND NON-COMMERCIAL USE OF A CONSUMER TO (i) ENCODE VIDEO IN COMPLIANCE WITH THE VC-1 STANDARD ("VC-1 VIDEO") AND/OR (ii) DECODE VC-1 VIDEO THAT WAS ENCODED BY A CONSUMER ENGAGED IN A PERSONAL AND NON-COMMERCIAL ACTIVITY AND/OR WAS OBTAINED FROM A VIDEO PROVIDER LICENSED TO PROVIDE VC-1 VIDEO. NO LICENSE IS GRANTED OR SHALL BE IMPLIED FOR ANY OTHER USE. ADDITIONAL INFORMATION MAY BE OBTAINED FROM MPEG LA, L.L.C. SEE [HTTP://WWW.MPEGLA.COM](http://www.mpegla.com)

- THIS PRODUCT IS LICENSED UNDER THE AVC PATENT PORTFOLIO LICENSE FOR THE PERSONAL USE OF A CONSUMER OR OTHER USES IN WHICH IT DOES NOT RECEIVE REMUNERATION TO (i) ENCODE VIDEO IN COMPLIANCE WITH THE AVC STANDARD ("AVC VIDEO") AND/OR (ii) DECODE AVC VIDEO THAT WAS ENCODED BY A CONSUMER ENGAGED IN A PERSONAL ACTIVITY AND/OR WAS OBTAINED FROM A VIDEO PROVIDER LICENSED TO PROVIDE AVC VIDEO. NO LICENSE IS GRANTED OR SHALL BE IMPLIED FOR ANY OTHER USE. ADDITIONAL INFORMATION MAY BE OBTAINED FROM MPEG LA, L.L.C. SEE [HTTP://WWW.MPEGLA.COM](http://www.mpegla.com)

- THIS PRODUCT IS LICENSED UNDER THE MPEG-4 VISUAL PATENT PORTFOLIO LICENSE FOR THE PERSONAL AND NON-COMMERCIAL USE OF A CONSUMER FOR (i) ENCODING VIDEO IN COMPLIANCE WITH THE MPEG-4 VISUAL STANDARD ("MPEG-4 VIDEO") AND/OR (ii) DECODING MPEG-4 VIDEO THAT WAS ENCODED BY A CONSUMER ENGAGED IN A PERSONAL AND NON-COMMERCIAL ACTIVITY AND/OR WAS OBTAINED FROM A VIDEO PROVIDER LICENSED BY MPEG LA TO PROVIDE MPEG-4 VIDEO. NO LICENSE IS GRANTED OR SHALL BE IMPLIED FOR ANY OTHER USE. ADDITIONAL INFORMATION INCLUDING THAT RELATING TO PROMOTIONAL, INTERNAL AND COMMERCIAL USES AND LICENSING MAY BE OBTAINED FROM MPEG LA, L.L.C. SEE [HTTP://WWW.MPEGLA.COM](http://www.mpegla.com)

TV

Item		Model: 4T-C50AL1X / 4T-C50AL2X	Model: 4T-C60AL1X	Model: 4T-C70AL1X
LCD panel		126 cm	153 cm	177 cm
Resolution		8,294,400 pixels (3840 x 2160)		
Video colour system		PAL/SECAM/NTSC 3.58/NTSC 4.43/PAL 60		
TV Function	TV-standard	Analogue	PAL: B/G, D/K, I SECAM: B/G, D/K, K/K1 NTSC: M	
		Digital	DVB-T / DVB-T2	
	Receiving Channel	VHF/UHF	44.25—863.25 MHz	
		CATV	S1—S41 ch (including Hyperband)	
TV-tuning system		Auto Preset 99 ch		
STEREO/BILINGUAL		NICAM: B/G, I, D/K A2 stereo: B/G MTS: M		
Audio amplifier		10 W x 2		
Terminals	ANT (Antenna input)	UHF/VHF 75 Ω DIN type		
	SERVICE ONLY	Ø 3.5 mm jack		
	INPUT 1 HDMI	HDMI (HDMI input)		
	INPUT 2 (ARC) HDMI	HDMI (HDMI input), ARC		
	INPUT 3 HDMI	HDMI (HDMI input)		
	INPUT 4 HDMI	HDMI (HDMI input)		
	INPUT 5	AUDIO in, VIDEO in		
	USB 1	USB (DC5V 1.2A output)		
	USB 2	USB (DC5V 1.2A output)		
	ETHERNET (10/100 BASE-T)	Network connector		
DIGITAL AUDIO OUTPUT	Optical S/PDIF digital audio output			
OUTPUT	Ø 3.5 mm stereo jack (audio output)			
OSD language		English (UK)/English (US)/Simplified Chinese/Arabic/French/Portuguese/Russian/Persian/Thai/Vietnamese/Indonesia/Malay		
Power Requirement		AC 110 — 240 V, 50/60 Hz		
Power Consumption		150 W (0.95 W Standby)	189 W (0.6 W Standby)	225 W (0.6 W Standby)
Dimensions	without stand	1122 (W) x 666 (H) x 74 (D) mm	1359 (W) x 790 (H) x 50 (D) mm	1563 (W) x 904 (H) x 52 (D) mm
	with stand	1122 (W) x 708 (H) x 253 (D) mm	1359 (W) x 852 (H) x 257 (D) mm	1563 (W) x 978 (H) x 334 (D) mm
Weight without stand (with stand)		12.5 kg (13.0 kg)	20.8 kg (21.5 kg)	31.5 kg (32.5 kg)
Operating temperature		0°C to +40°C		

- As a part of policy of continuous improvement, SHARP reserves the right to make design and specification changes for product improvement without prior notice. The performance specification figures indicated are nominal values of production units. There may be some deviations from these values in individual units.
- Specification may differ depending on the selected country.

CAUTION

- Installing the Liquid Crystal Television requires special skill that should only be performed by qualified service personnel. Customers should not attempt to do the work themselves. SHARP bears no responsibility for improper mounting or mounting that results in accident or injury.
- Carefully read the instructions that come with the bracket before beginning work.

Wireless LAN

Specification	
Standard	IEEE 802.11a/b/g/n/ac
Security	Static WEP (64/128 bit key index 1 only) WPA-PSK (TKIP) WPA2-PSK (AES)
Modulation	IEEE802.11b: DBPSK, DQPSK, CCK / DSSS HRDSSS IEEE802.11a: BPSK, QPSK, 16QAM, DBPSK, DQPSK, CCK / OFDM IEEE802.11g: BPSK, QPSK, 16QAM, DBPSK, DQPSK, CCK, PBCC / OFDM IEEE802.11n: BPSK, QPSK, 16QAM, 64QAM / OFDM IEEE802.11ac: BPSK, QPSK, 16QAM, 64QAM, 256QAM / OFDM
Throughput	IEEE802.11b: 1, 2.5, 5, 11Mbps IEEE802.11a: 6, 9, 12, 18, 24, 36, 48, 54Mbps IEEE802.11g: 6, 9, 12, 18, 24, 36, 48, 54Mbps IEEE802.11n: ~300Mbps IEEE802.11ac: ~866.6Mbps

4T-C50AL1X / 4T-C50AL2X

Unit: mm

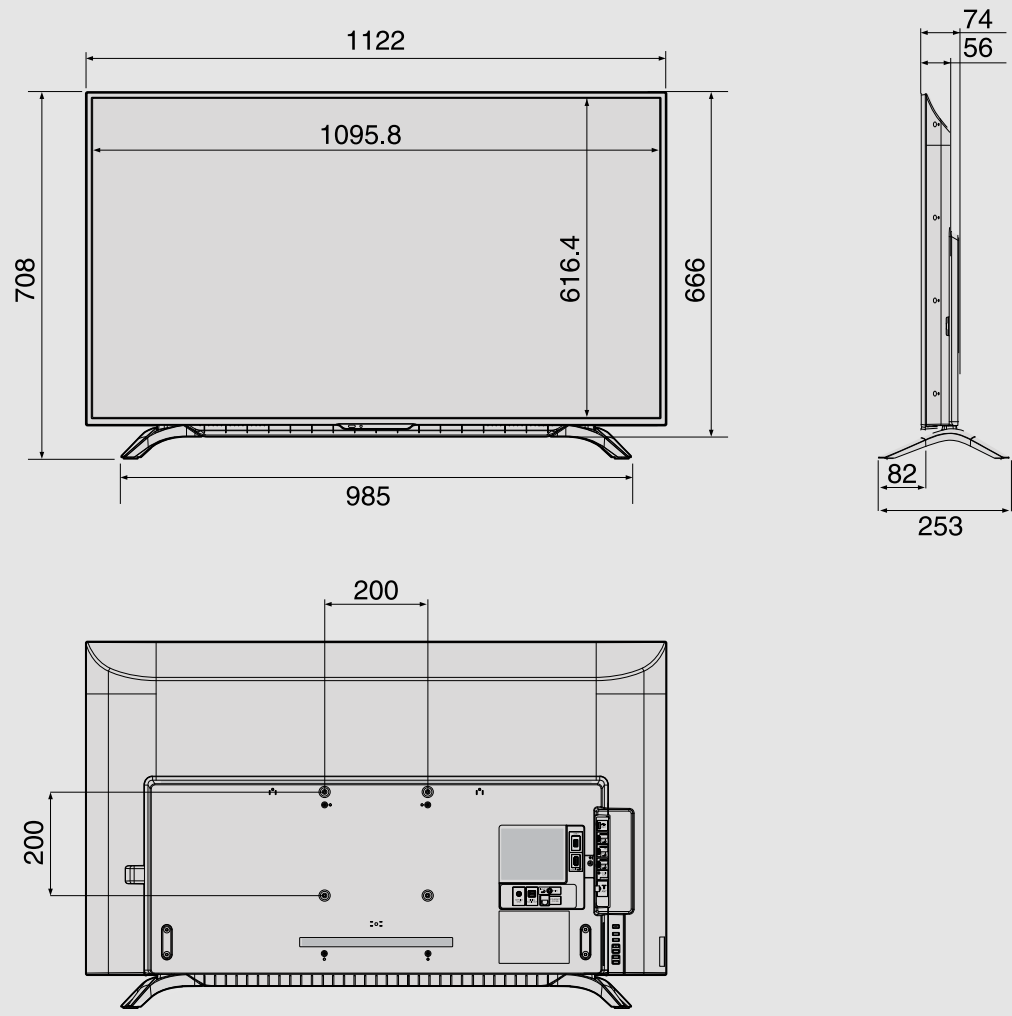

EN 13-1

4T-C60AL1X

Unit: mm

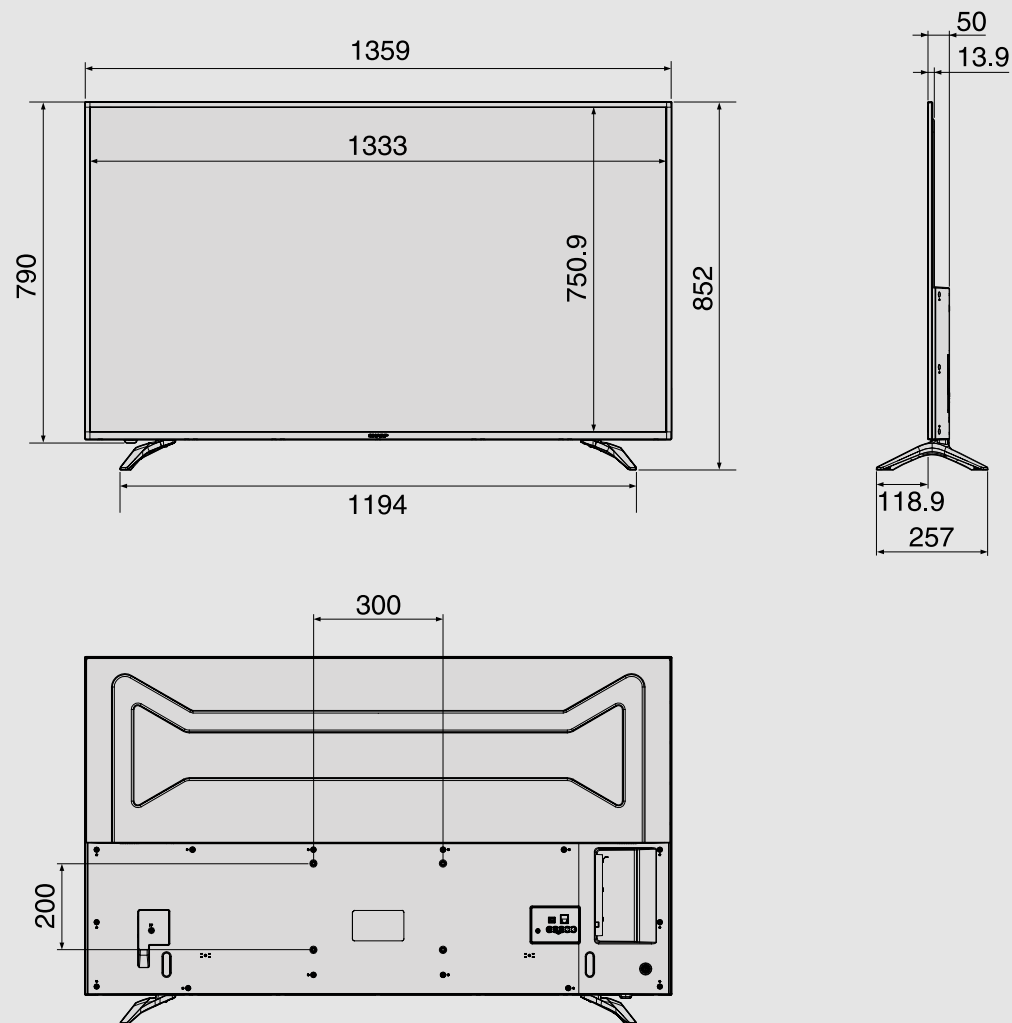

EN 13-2

4T-C70AL1X

Unit: mm

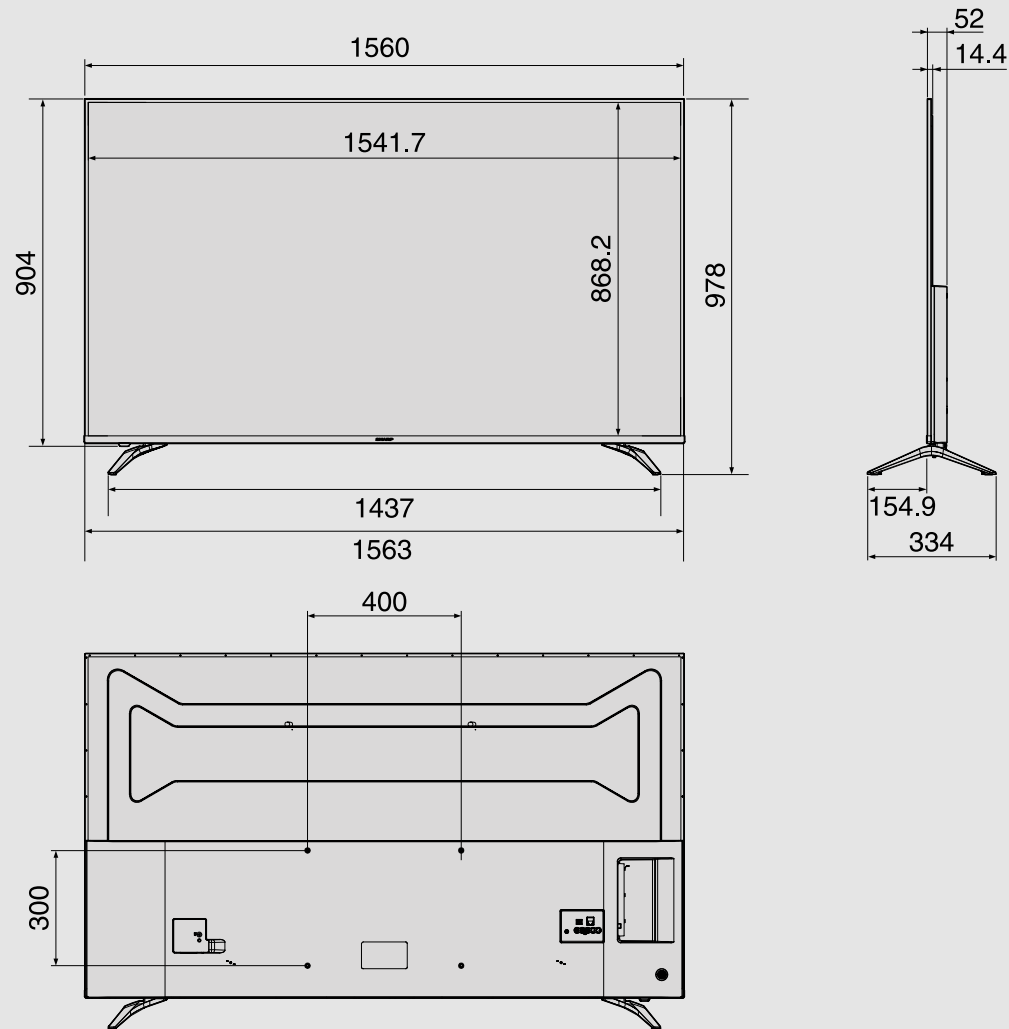

EN 13-3



SHARP[®]
SHARP CORPORATION