





SHARP®

AQUOS

LED BACKLIGHT TV

OPERATION MANUAL

- Please choose your favourite page from the content.
If you want to close the operation manual, press the  (HOME) button.
Also, if you want to return to the previously displayed page, press the  (BACK) button.



ENGLISH | FRANÇAIS | PORTUGUÊS | РУССКИЙ | 中文 | INDONESIA | ภาษาไทย | TIẾNG VIỆT | عربي | АҒЫЛШЫН | O'ZBEK TILIDA

1. Part Names

- 1-1. TV
- 1-3. Remote Control Unit

2. Watching TV

- 2-1. Displaying an External Equipment Image
- 2-2. Initial Installation

3. Direct Button Operation

- 3-1. Changing Channels
- 3-2. Changing Volume
- 3-3. MUTE
- 3-4. AD/MPX
- 3-5. BROWSER
- 3-6. YouTube
- 3-7. HOME

4. On-Screen Display Menu

- 4-1. Introduction
- 4-3. On-Screen Display Menu Operation
- 4-4. Menu Operation Buttons
- 4-5. Initial setup
- 4-16. Information
- 4-22. Picture settings
- 4-24. Audio settings
- 4-25. Smart TV
- 4-30. System options

5. Enjoying Photo/Music/Video Playback

- 5-1. Preparation
- 5-3. USB Media Player
- 5-4. Selecting the Folders to Play Back
- 5-6. Playing Back Files on a USB Memory Device/Home Network Server

6. Using LINK Operation

- 6-1. Controlling HDMI Equipment Using LINK Operation

7. Using a PC

- 7-1. Control of the TV
- 7-7. PC Compatibility Chart

8. Using the Internet

- 8-1. Connecting to the Internet
- 8-4. Smart TV
- 8-7. Entering Text (Software Keyboard)
- 8-9. Using the Browser
- 8-14. Using Keyboard and Mouse
- 8-15. Using Applications via the Internet

9. Appendix

- 9-1. Troubleshooting
- 9-3. Troubleshooting - Error Message
- 9-4. Information on the Software License for This Product

10. Trademarks**11. Specifications**

- 11-1. TV
- 11-2. Wireless LAN

12. Dimensional Drawings

- 12-1. 4T-C50AH1X

Precautions For Daily Use

Observe the following items

Maintenance of the cabinet

- When cleaning the cabinet, use a soft cloth (made of cotton, floss, etc.) to clean gently.
- Do not use a dry or damp rag mixed with chemicals, as this could cause the ingredients of the cabinet body to deteriorate or crack.
- Be careful not to use an abrasive cloth for cleaning or clean with excessive force, as this could scratch the surface of the cabinet.
- If the cabinet is greatly soiled, clean with a soft cloth (made of cotton, floss, etc.) soaked with a small amount of diluted neutral detergent and wrung out, and then clean with a soft dry cloth.
- Solvents such as benzene or thinner could cause the cabinet to deteriorate, or make its coating come off. Therefore do not use such solvents to clean the cabinet.
- Because plasticizer is included in the plastics, deterioration or the coating peeling off could occur when the cabinet comes into contact with some substances. Therefore keep it away from volatile substances such as insecticide. In addition, do not let it come into contact with objects made of rubber, resin, etc. for a long time.

Maintenance of the LCD panel

- Before cleaning the LCD panel, be sure to turn off the TV set and unplug the power cord from the outlet.
- When cleaning the LCD panel, use a dry and soft cloth (made of cotton, floss, etc.) to clean the surface of the LCD panel gently. For protecting the LCD panel, do not clean with a dirty cloth, detergent, or a dry or damp rag mixed with chemicals, as this could cause peeling of the panel surface.
- Be careful not to clean with an abrasive cloth or with excessive force, as this could cause the panel surface to be scratched.
- If the LCD panel is greatly soiled, clean it gently with a soft cloth (made of cotton, floss, etc.) soaked with a small amount of water (Do not clean with excessive force, so as to avoid the scratch of the panel surface).
- If dust sticks on the surface of the LCD panel, clean the panel with a commercially available cleaning brush (anti-static brush).

Important safety precautions

Caring for the cabinet

- Use a soft cloth (cotton, flannel, etc.) and gently wipe the surface of the cabinet.
- Using a chemical cloth (wet/dry sheet type cloth, etc.) may deform the components of the main unit cabinet or cause cracking.
- Wiping with a hard cloth or using strong force may scratch the surface of the cabinet.
- If the cabinet is very dirty, wipe with a soft cloth (cotton, flannel, etc.) soaked in neutral detergent diluted with water and thoroughly wrung out, and then wipe with a soft dry cloth.
- The cabinet is primarily made of plastic. Avoid using benzene, thinner, and other solvents, as these may deform the cabinet and cause the paint to peel off.
- Do not apply insecticides or other volatile liquids.
- Also, do not allow the cabinet to remain in contact with rubber or vinyl products for a long period of time. Plasticizers inside the plastic may cause the cabinet to deform and cause the paint to peel off.
- When relocating the product placed on a cart, it must be moved with utmost care. Sudden stops, excessive force and uneven floor surface can cause the product to fall from the cart.



Caring for the front panel

- Turn off the main power and unplug the AC cord from the wall outlet before handling.
- Gently wipe the surface of the front panel with a soft cloth (cotton, flannel, etc.).
- To protect the front panel, do not use a dirty cloth, liquid cleaners, or a chemical cloth (wet/dry sheet type cloth, etc.). This may damage the surface of the front panel.
- Wiping with a hard cloth or using strong force may scratch the surface of the front panel.
- Use a soft damp cloth to gently wipe the front panel when it is really dirty (It may scratch the surface of the front panel when wiped strongly).
- If the front panel is dusty, use an anti-static brush, which is commercially available, to clean it.
- Water and moisture — Do not use the product near water, such as bathtub, washbasin, kitchen sink, laundry tub, swimming pool and in a wet basement.



Introduction

- Do not place vases or any other water-filled containers on this product. The water may spill onto the product causing fire or electric shock.



- Stand — Do not place the product on an unstable cart, stand, tripod or table. Doing so can cause the product to fall, resulting in serious personal injuries as well as damage to the product. Use only a cart, stand, tripod, bracket or table recommended by the manufacturer or sold with the product. When mounting the product on a wall, be sure to follow the manufacturer's instructions. Use only the mounting hardware recommended by the manufacturer.



- Ventilation — The vents and other openings in the cabinet are designed for ventilation. Do not cover or block these vents and openings since insufficient ventilation can cause overheating and/or shorten the life of the product. Do not place the product on a bed, sofa, rug or other similar surface, since they can block ventilation openings. This product is not designed for built-in installation; do not place the product in an enclosed place such as a bookcase or rack, unless proper ventilation is provided or the manufacturer's instructions are followed.



- In case the product is dropped and the cabinet is damaged, be sure to turn off the power of the product, and unplug the power cord. If you continue to use the product, it may cause fire or electric shock. Contact your dealer.



- Do not open the rear cover of the cabinet to reconstruct the circuits. There exists high voltage within the cabinet and it may cause electric shock and injury. If maintenance is required, contact your dealer.



- The LCD panel used in this product is made of glass. Therefore, it can break when the product is struck forcefully or with a sharp object. If the LCD panel is broken, be careful not to be injured by broken glass.



- Heat sources — Keep the product away from heat sources such as radiators, heaters, stoves and other heat-generating products (including amplifiers).



Do not install the TV in a location in which it will be subject to water drops such as underneath an air conditioning unit or in the vicinity of a humidifier



- Water drops falling onto the TV and water entering inside it may result in fire, electric shock, or malfunctions. We recommend that you install the TV at least 1 m away from the outlet of an air conditioner.

- To prevent fire, never place any type of candle or naked flames on the top or near the TV set.



- To prevent fire or shock hazard, do not place the AC power cord under the TV set or other heavy items.



- Do not place heavy objects on this product or stand on it. Doing so could cause injury if the product overturns. Take special care near children and pets.



- Unplug the power cord before you move the TV set. If not unplugged beforehand, the power cord may become damaged and cause electric shock.



The LCD panel is a very high technology product with 8,294,400 pixels, giving you fine picture details. Due to the very large number of pixels, occasionally a few non-active pixels may appear on the screen as a fixed point of blue, green, red or yellow. This is within product specifications and does not constitute a fault.

Precautions when transporting the TV

- When transporting the TV, never carry it by holding or otherwise putting pressure onto the display. Be sure to always carry the TV by two or more people holding it with two hands — one hand on each side of the TV.



If a television is not positioned in a sufficiently stable location, it can be potentially hazardous due to falling. Many injuries, particularly to children, can be avoided by taking simple precautions such as:

- Using cabinets or stands recommended by the manufacturer of the television.
- Only using furniture that can safely support the television.
- Ensuring the television is not overhanging the edge of the supporting furniture.
- Not placing the television on tall furniture (for example, cupboards or bookcases) without anchoring both the furniture and the television to a suitable support.
- Not standing the televisions on cloth or other materials placed between the television and supporting furniture.
- Educating children about the dangers of climbing on furniture to reach the television or its controls.

- Do not display a still picture for a long time, as this could cause an afterimage to remain.

- Install the product on the place where the AC cord can be unplugged easily from the AC outlet, or from the AC INPUT terminal on the rear of the product.

NOTE

- The above are pictures for reference only; the actual item might be different.

TV

(Front)

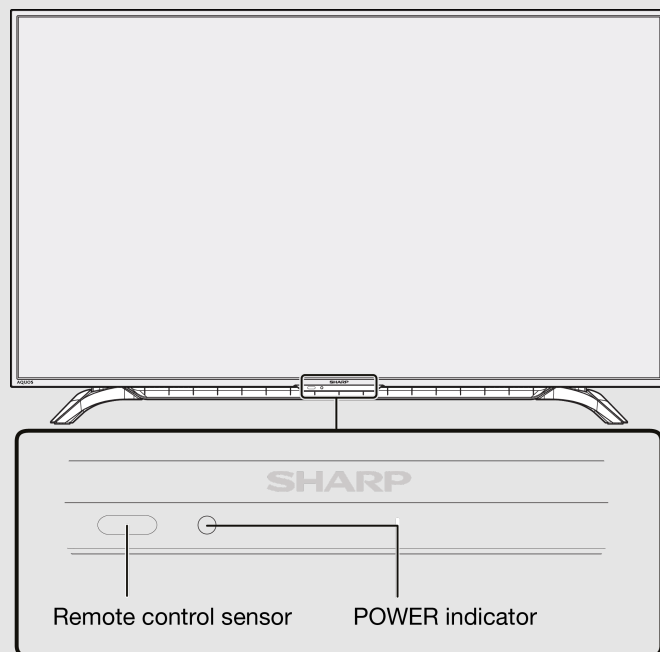

(Side)

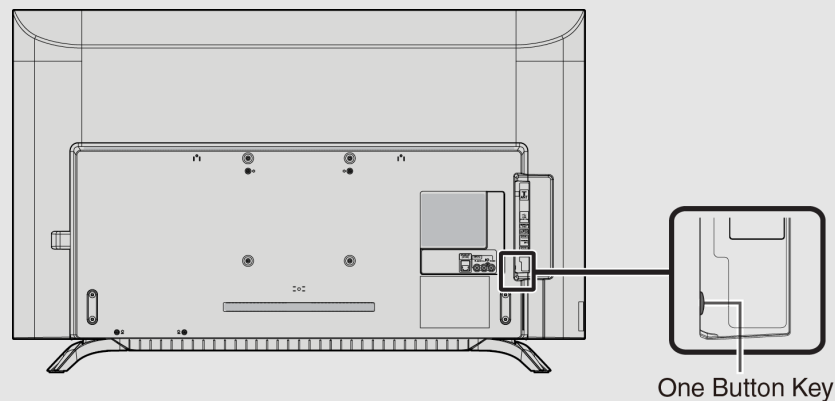

One Button Key	Functions Descriptions
Single Press	On/Off (No OSD display)
Long Press	Sub-menu display on TV screen (10s timeout)
Function During Menu	1. INPUT* 2. CH \blacktriangle * 3. CH \blacktriangledown * 4. VOL +* 5. VOL -*

* Single Press: Scroll Down

* Hold Press: Select item

- The illustrations and on-screen displays in this operation manual are for explanation purposes and may vary slightly from the actual operations.

TV (Continue)

(Rear)

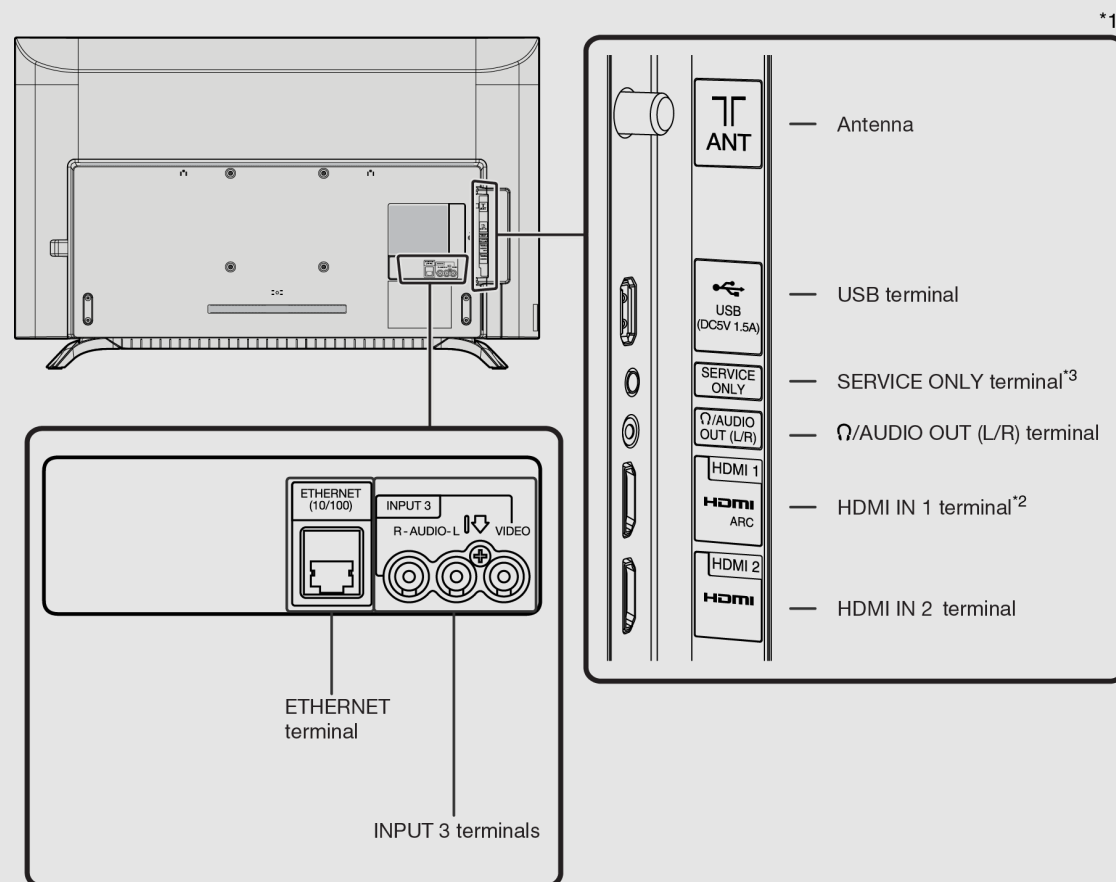

*1 See the Setup Guide. And [see page 6-1](#) for external equipment connection.

*2 Use HDMI IN 1 to connect ARC-compatible equipment.

*3 Usually do not connect anything to this terminal as it reserved only for service personnel.

Remote Control Unit



- 1 POWER:** Switch the TV power on or enter standby.
- 2 0-9:** Set the channel. ([See page 3-1.](#))
- 3 AD/MPX:** Select the sound multiplex mode and audio description. ([See page 3-4.](#))
- 4 (BROWSER):** Display the BROWSER screen.
- 5 (BACK):** Return to the previous screen.
- 6 , ENTER:** Select a desired item on the screen.
- 7 VOL+/-:** Set the volume. ([See page 3-2.](#))
- 8 R, G, Y, B:** The coloured buttons are correspondingly used to select the coloured items on the screen.
- 9 AV MODE:** Select the video setting. ([See page 4-22.](#))
- 10 SUPER ECO:** Reduce backlight brightness to save power consumption.
- 11 EPG**
DTV: Display the EPG screen.
- 12 YouTube:** Display the YouTube screen.
- 13 (HOME):** Display the HOME screen. ([See page 3-7.](#))
- 14 (MUTE):** Mute the sound. ([See page 3-3.](#))
- 15 CH :** Select the channel. ([See page 3-1.](#))

Displaying an External Equipment Image

To view external source images, select the input source by pressing  (**HOME**) on the remote control unit or **One Button Key** on the TV.

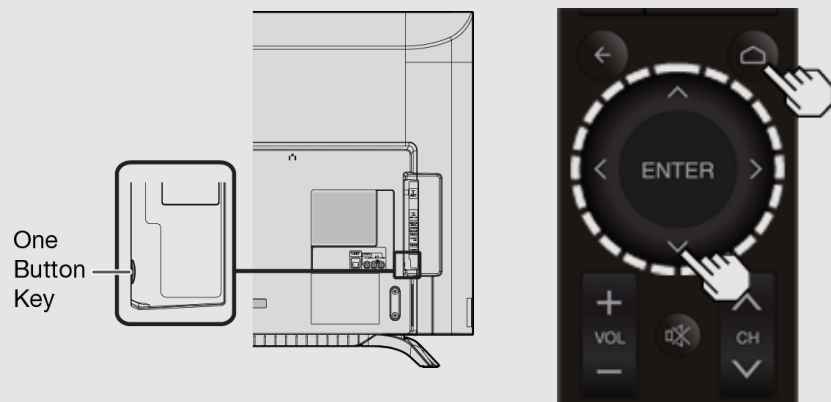

Example

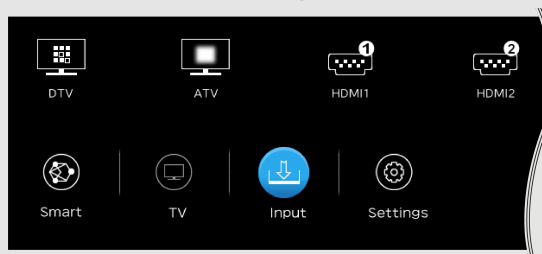

- 1 Press  (**HOME**) to display the HOME screen.
- 2 Press **</>** to select "Input".
- 3 Press **^**, press **</>** to select the input source, and then press **ENTER**.
 - An image from the selected source automatically displays.

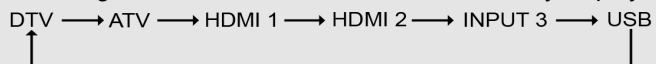



Initial Installation

Perform the following steps before you press **POWER** on the remote control unit.

1. Insert the batteries into the remote control unit.
2. Connect the antenna cable to the TV.
3. Plug in the AC cord to the AC outlet.
4. Press **POWER** on the remote control.
 - The initial auto installation wizard appears. Press **ENTER** to start the wizard.

Language (Language setting)

Select from among 13 languages. (English, Simplified Chinese, Arabic, French, Portuguese, Russian, Persian, Thai, Vietnamese, Indonesian, Hebrew, Hindi and Malay)

- 1 Press **^ / v** to select the desired language listed on the screen, and then press **ENTER**.

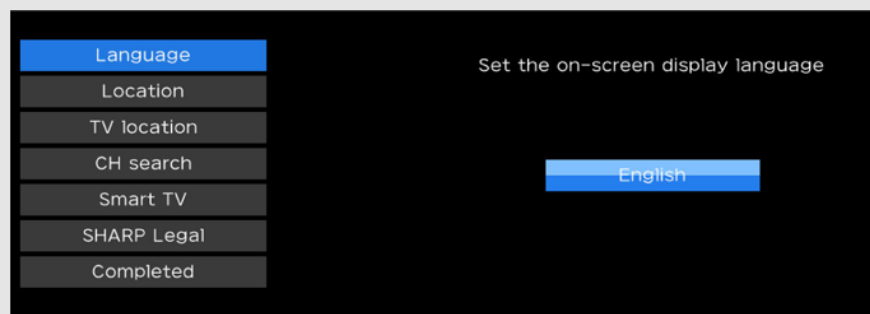

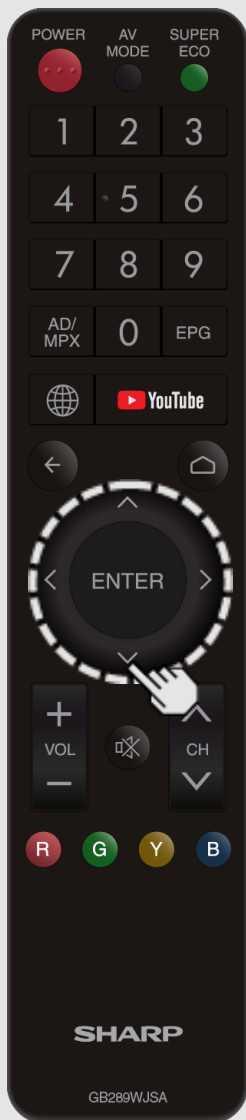

Initial Installation (Continue)

Location

Make settings for the country where you use the TV.

- 2 Press **^**/**v**/**<**/**>** to select "Iran", "Singapore", "Malaysia", "Morocco", "Vietnam", "Indonesia", "Myanmar", "Thailand", "Uzbekistan", "Philippines", "Kenya", "Tanzania", "Nigeria", "Angola", "United Arab Emirates", "Georgia", "Mauritius", "Egypt" or "Others", and then press **ENTER**.



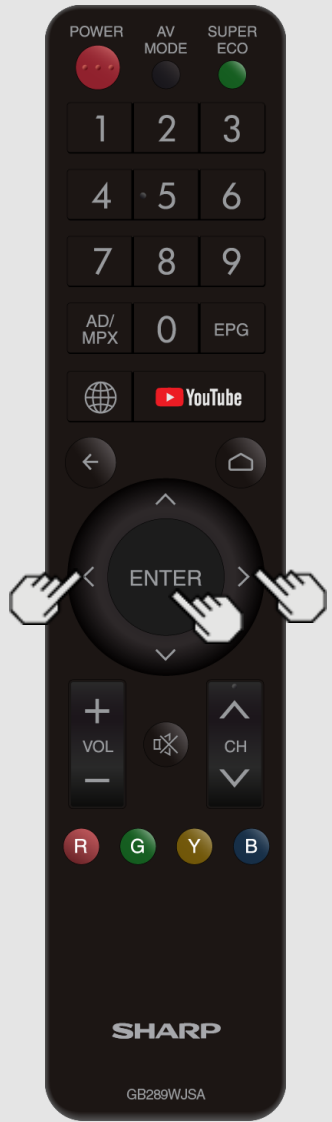

Initial Installation (Continue)

TV location
Select "Home" or "Store" for the location where you plan to install the TV.
3 Press </> to select "Home" or "Store". Press **ENTER** to enter the setting.
Home: AV Mode is set to "STANDARD".
Store: AV Mode is set to "DYNAMIC (Fixed)".



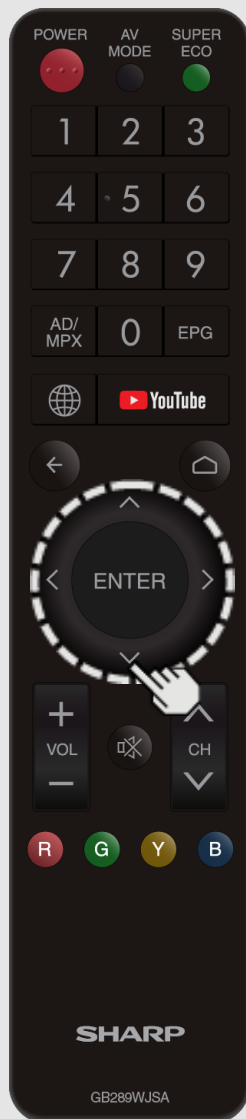

Initial Installation (Continue)

CH search (Channel search)

Channel auto search makes the TV look for all channels viewable in the set area.

4 Press \wedge / \vee to select "DTV", "ATV", or "DTV+ATV" in "Search type", and then press **ENTER**.

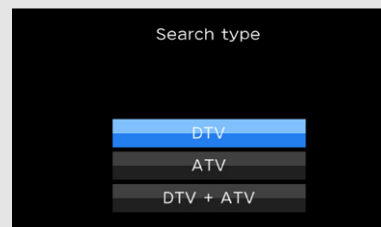

5 Press \langle / \rangle to select "Start", and then press **ENTER** for searching receivable channels.

- The Channel search will start automatically.
- To exit the Channel search screen, select "Cancel", and then press **ENTER**.



Initial Installation (Continue)

Smart TV

- Wireless LAN connection is possible only when the WPS (push button) method is used. If any other method is used, make settings by Smart TV > Internet Setup.

[\(See pages 8-4 to 8-6.\)](#)

6 Press </> to select "Yes", and then press **ENTER**.

7 Press ^/∨ to select "Wired" or "Wireless", and then press **ENTER**.

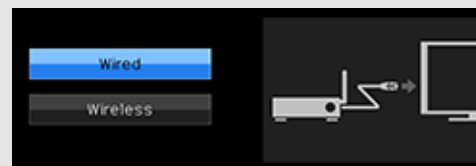

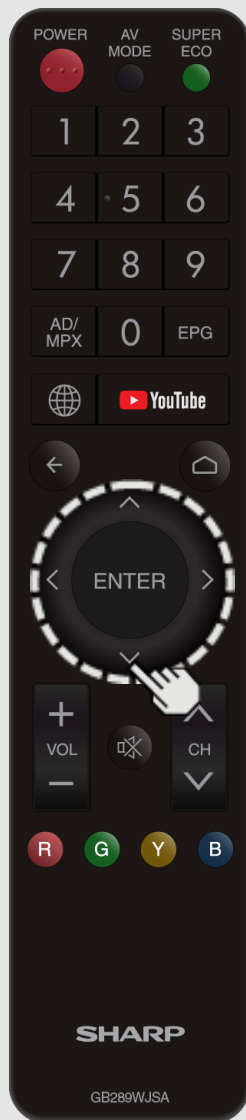

Initial Installation (Continue)

Connection using an ETHERNET cable:

- ① Select "Wired" and press **ENTER**.
- ② Confirm that the TV is properly connected with the router, and then press "Next". Follow the instructions on the display to perform the connection test.

Wireless LAN connection by the WPS method:

- ① Select "Wireless" and press **ENTER**.
- ② Follow the instructions on the display, and finalize the connection after testing its viability.

NOTE

- After you finish configuring the network settings, configure the "TV name setting".
(See page 4-27)
- When you change the network settings, refer to Smart TV > Internet Setup.
(See pages 8-4 to 8-6.)

SHARP Legal

- 8 Press \wedge / \vee to view Sharp Terms of Use and Sharp Privacy Policy.

Completed

- 9 The settings confirmation screen is displayed. Confirm the information displayed on the screen, click "OK" will complete the Easy Setup procedure.

Examples of the settings confirmation screen

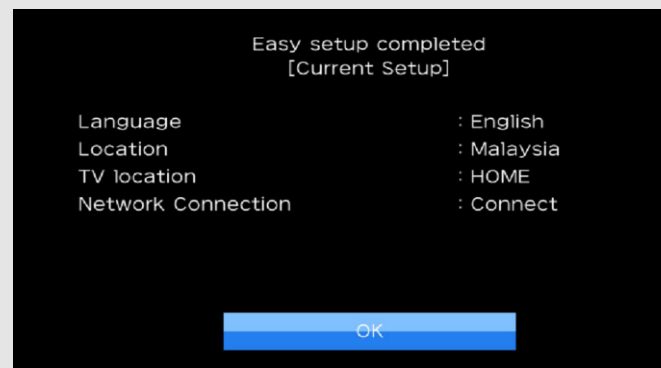

NOTE

- For changing the settings of the Initial Installation, perform "Easy setup" on the Initial Setup menu on [page 4-5](#).

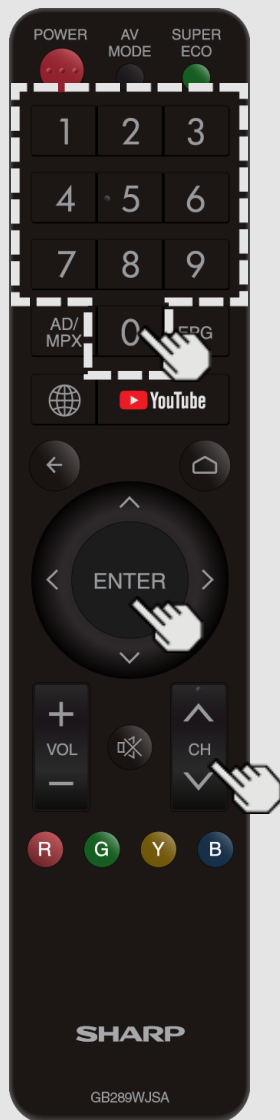

Changing Channels

You can change channels in several ways.

Method 1

Using **CH** \wedge / \vee on the remote control unit or on the TV.

Method 2

Using remote control buttons **0-9**.

Examples:

To select a 1 or 2-digit channel number (e. g., Channel 5):

Press **5** → **ENTER**

To select a 3-digit channel number (e. g., Channel 115):

Press **1** → **1** → **5** → **ENTER**

NOTE

- When selecting a 1-digit channel number, it is not necessary to press **0** before the number.
- When you enter **0-9** only, channel selection will be made if there is no operation within a few seconds.
- If you push "0" by itself, nothing will happen.
- Complete the above steps within a few seconds.



Changing Volume

You can change the volume by pressing **VOL +/-** on the TV or on the remote control unit.

- To increase the volume, press **VOL +**.
- To decrease the volume, press **VOL -**.



Audio status

Output device	Audio Output Select	
	Audio Out	Headphone
TV Speaker	Variable Sound	Mute
AUDIO OUT / HEADPHONE	Fixed Sound (Volume MAX)	Variable Sound



MUTE

Mutes the current sound output.

Press  (MUTE).

-  will be displayed on the screen for 30 minutes.

NOTE

- Mute can be cancelled by pressing **VOL+/-** or  (MUTE).



AD/MPX

Switching the digital audio format (DTV only)

If multi sound modes are received, each time you press **AD/MPX** the mode switches.

NOTE

- The sound mode screen disappears in three seconds.
- Selectable items vary depending on the received broadcasts.
- The audio description sound is selected depending on the main audio.

Switching the analogue audio format

You can switch between multiple audio modes when watching a multiple audio or stereo broadcast programme.

In the NICAM TV broadcasts

When receiving a stereo signal
 Each time you press **AD/MPX**, the mode switches between Nicam Stereo and Mono.



When receiving a bilingual signal

Each time you press **AD/MPX**, the mode switches among Nicam Dual I, Nicam Dual II and Mono.

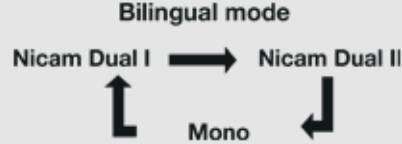

When receiving a monaural signal

Each time you press **AD/MPX**, the mode switches between Nicam Mono and Mono.

Monaural mode



In the TV mode of A2 TV broadcasts

When receiving a stereo signal

Each time you press **AD/MPX**, the mode switches between Stereo and Mono.

Stereo mode



When receiving a bilingual signal

Each time you press **AD/MPX**, the mode switches among Dual I and Dual II.

Bilingual mode



When receiving a monaural signal

When you press **AD/MPX**, "Mono" displays.

Monaural mode

Mono



BROWSER

Displays the BROWSER screen.

Press  (**BROWSER**).

NOTE

- Please press " (**HOME**)" key to exit BROWSER.



YouTube

Displays the YouTube screen.

Press **YouTube**.

NOTE

- If you press the **YouTube** button when the TV in standby mode, the TV turns on and the YouTube screen is displayed.
- To enjoy YouTube, you need to make:
 - a broadband Internet connection
([See page 8-1.](#))
 - settings of Internet Setup
([See pages 8-4 to 8-6.](#))

**HOME**

Displays the HOME screen.



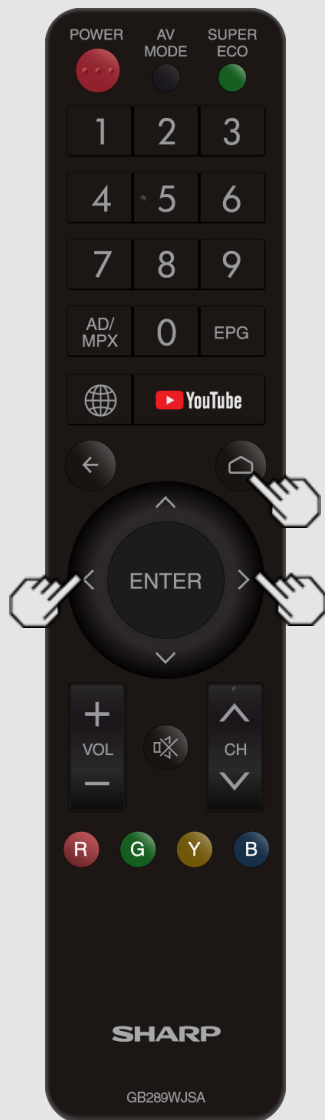

Press  (HOME).

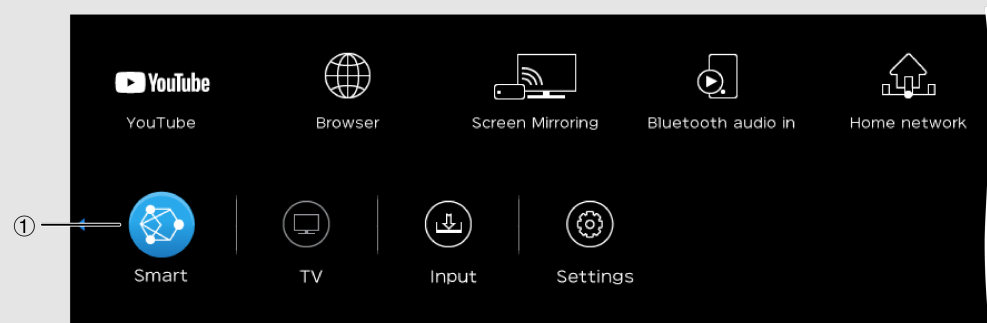

Introduction

Home menu screen



- 1 Press  (HOME) to display the HOME screen.
- 2  Press  to select the desired menu.
 - Smart - YouTube, Browser, Screen Mirroring, Bluetooth audio in, Home network
 - TV - Channel list, Teletext
 - Input - Switch the input (DTV, ATV, HDMI 1, HDMI 2, INPUT 3, USB)
 - Settings - Audio settings, Internet setup, Subtitle, Menu, Manual
- 3 Press  (HOME) to exit.



Introduction (Continue)

About Menu Items

- Some menu items may not be displayed depending on the selected input source.

NOTE

- The screens in the operation manual are for explanation purposes (some are enlarged, others cropped) and may vary slightly from the actual screens.
- The order of explanations for each menu item in the following pages is not necessarily in accordance with the alignment of the items on the screen.



On-Screen Display Menu Operation

Example



1 Press (HOME) to display the HOME screen.

2 Press / to select "Settings", press , press / to select "Menu", and then press **ENTER**.

3 ① Press / to select the desired menu.

② Press / to select a specific adjustment item, and then press **ENTER**.

- Additional related adjustment items may be displayed. Press / to select the desired item.

③ Adjust the item while referring to the guide display.

- Operations vary depending on the function or item. Refer to the guide display corresponding to the menu setting screen for button operations.

4 Press (HOME) to exit.

NOTE

- Menu options differ in the selected input modes, but the operating procedures are the same.

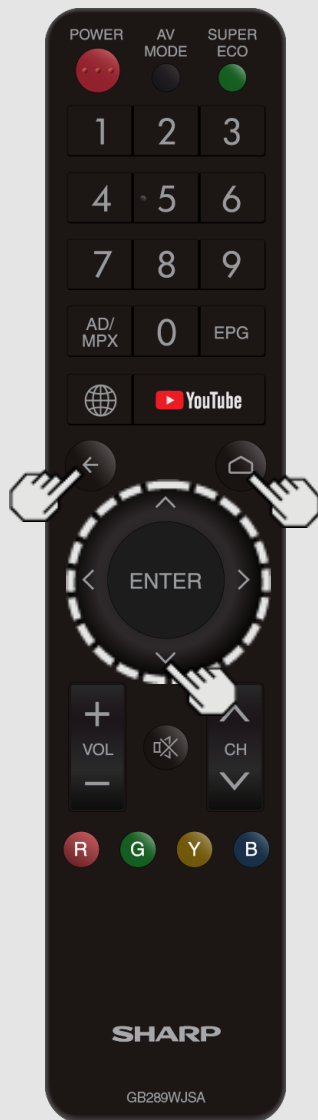

Menu Operation Buttons

Using the remote control

Use the following buttons on the remote control to operate the menu.

HOME: Press **HOME** to display the HOME screen.

▲/▼/◀/▶: Press to select a desired item on the screen or adjust a selected item.

ENTER: Press to go to the next step or complete the setting.

◀ (BACK): Press to return to the previous step.

Example

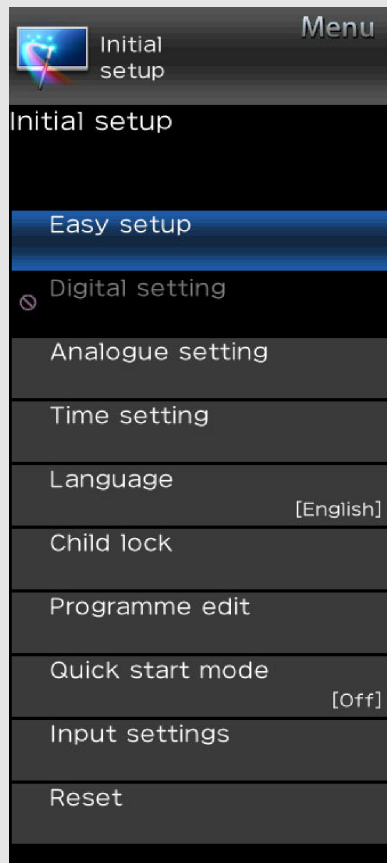

Initial setup

Easy setup

You can run Easy setup again, even after setting up the preset channels.

Language: Select from among 13 languages. (English, Simplified Chinese, Arabic, French, Portuguese, Russian, Persian, Thai, Vietnamese, Indonesian, Hebrew, Hindi and Malay).

Location : Make settings for the country where you use the TV.

- **Select your country:** Select either "Iran", "Singapore", "Malaysia", "Morocco", "Vietnam", "Indonesia", "Myanmar", "Thailand", "Uzbekistan", "Philippines", "Kenya", "Tanzania", "Nigeria", "Angola", "United Arab Emirates", "Georgia", "Mauritius", "Egypt" or "Others".

TV location: Select "Home" or "Store" for the location where you plan to install the TV.

- **Home:** AV Mode is set to "STANDARD".
- **Store:** AV Mode is set to "DYNAMIC (Fixed)".

CH search: Channel auto search makes the TV look for all channels viewable in the set area.

Smart TV: When you connect to the Internet on the TV, confirm the connection method and make adjustments.

- Wireless LAN connection is possible only when the WPS (push button) method is used. If any other method is used, make settings by Smart TV > Internet Setup.

[\(See pages 8-4 to 8-6.\)](#)

SHARP Legal: To view Sharp Terms of Use and Sharp Privacy Policy.

Completed: The settings confirmation screen is displayed. Confirm the information displayed on the screen.

NOTE

- See Initial Installation on [pages 2-2 to 2-7](#) for setting each item.
- If no channel is found, confirm the type of connection made with your TV and try "Easy setup" again.
- "Time zone" enables you to select your local time zone and then press **0-9** to enter postal code. (Only for Indonesia).
- The "DTV" and "DTV+ATV" selection does not work when country selected is Phillipines.



Example

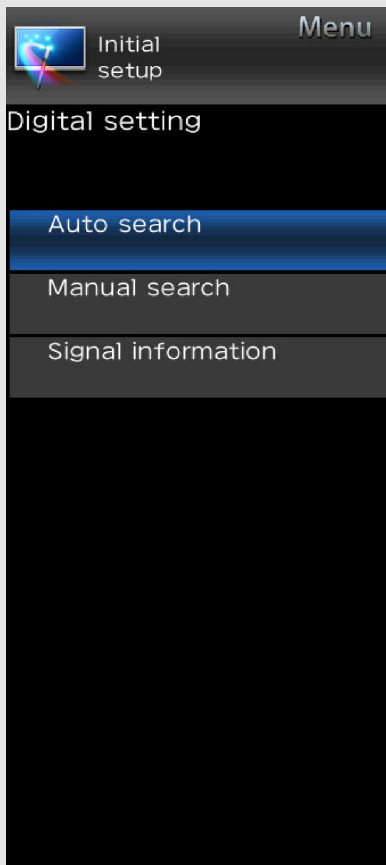

Initial setup (Continue)

Digital setting

You can reconfigure DTV services settings automatically or manually.

- If you have already set the password, enter it here. See "Child Lock" to set password.

Auto search

Use this menu to add new services automatically after auto installation has been completed.

- Press \wedge / \vee to select "DTV" or "DTV+ATV".

Manual search

Add new services within a specified frequency band.

- Press \langle / \rangle to find the channel and then press **ENTER** .

Signal information

Use this menu to check signal information depends on receiving channel.

NOTE

- This selection does not work when country selected is Phillipines.

Example

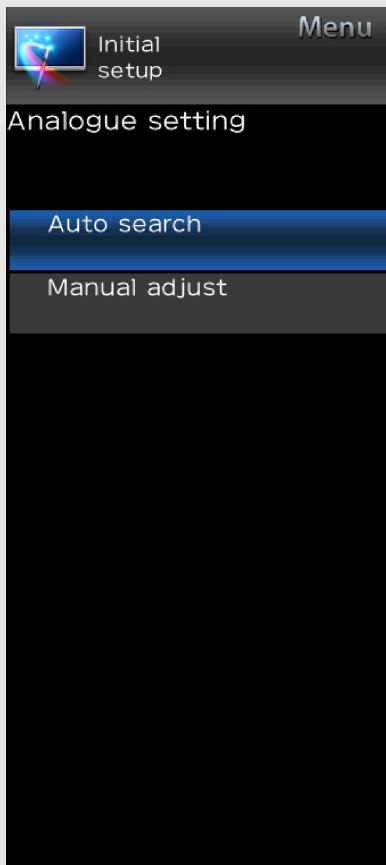

Initial setup (Continue)

Analogue setting

You can reconfigure the TV channel settings automatically or manually using **Auto search** or **Manual adjust**.

Auto search

Use this menu to add new services automatically after auto installation has been completed.

- If you have already set the password, enter it here. See "Child Lock" to set password.
- You do not need to do anything during the auto search.

Manual adjust

You can set some channel items manually.

Current CH: Select the channel you want to edit.

Sound system: Select the optimum sound system (Broadcasting system) to receive. (B/G, D/K, I, M).

Colour system: Select the optimum colour system to receive. (NTSC 3.58, NTSC 4.43, PAL, SECAM).

Search: Start searching from current channel.

Fine-tune: Tune the frequency of the stored channel to your desired position.

NOTE

- The frequency shown below the On-Screen Display shows the real-time frequency of the displayed channel.

Example

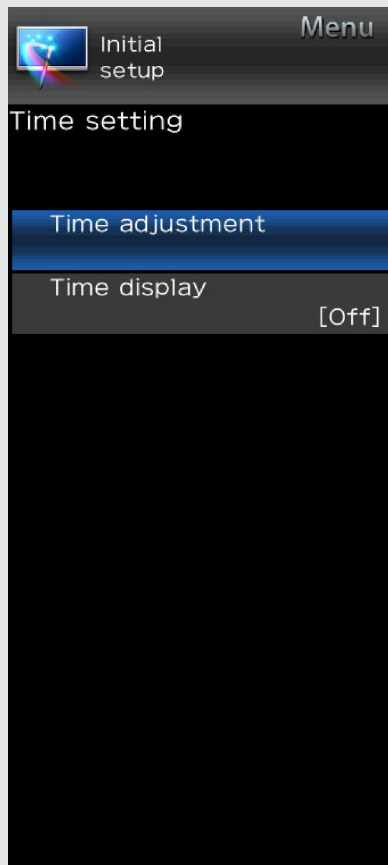

Initial setup (Continue)

Time setting

This function can display the time, data on screen and channel's timetable with updated time info.

Time adjustment

This function allows you to set the clock manually.

NOTE

- If you select "On" in "Auto synchronization" the TV will try to get the time for the broadcast. It will only be selectable when "Auto synchronization" is set to "Off".
- "Time zone" enables you to select your local time zone. It will only be selectable when "Auto synchronization" is set to "On".

Time display

This function allows you to display the clock time in the lower-right corner of the screen.

Off: Hides the clock time.

On: Displays the clock time.

NOTE

- Time information is available when channel time information including the teletext information is obtained in the "TV" mode.



Example

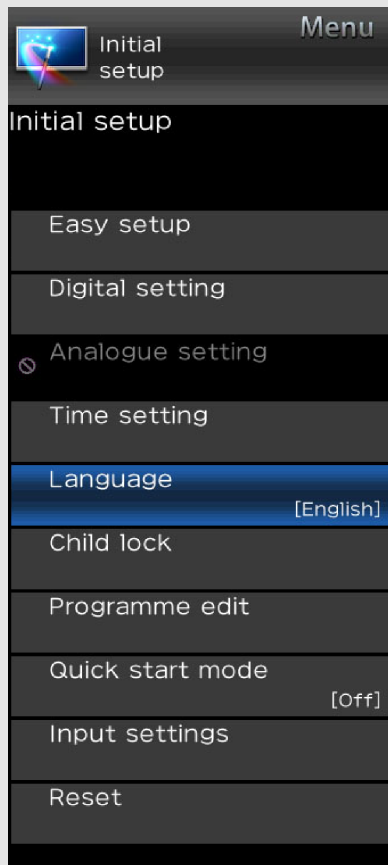

Initial setup (Continue)

Language

You can select a language. Select from among 13 languages. (English, Simplified Chinese, Arabic, French, Portuguese, Russian, Persian, Thai, Vietnamese, Indonesian, Hebrew, Hindi and Malay.)

NOTE

- To change the language of the manual, select "  (HOME)" > "Settings" > "Menu" > "Initial setup" > "Language" to change the language. Then, press **ENTER**.

Example

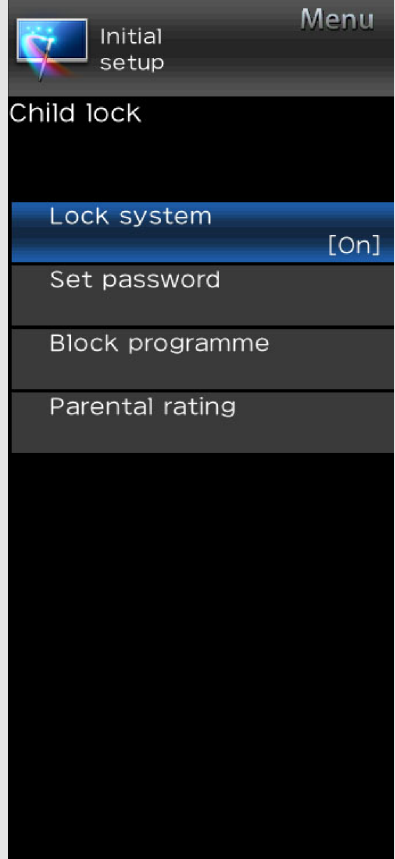

Initial setup (Continue)

Child lock

Allows you to use a password to protect certain settings from being accidentally changed.

Lock system

If the password is not set, the "Lock system" is invalid. Please make sure the "Lock system" is set to "On" before the Child lock is set. (Off, On).

Set password

You can set and change the Password by using 0-9.

NOTE

- To view a locked channel, you must enter a password. When you select a locked channel, "Child lock has been activated" is displayed and then enter the password.

Block programme

The "Block programme" can be select after "Lock system" is set to "On".

Parental rating

This function allows TV channels to be restricted. It prevents children from watching violent or sexual scenes that may be considered inappropriate.

Off: Cancel the blocking.

Age xx years: Select desired age to block. (Example) If age 14 is selected, programmes rated for ages of 15 or more are blocked.



Example

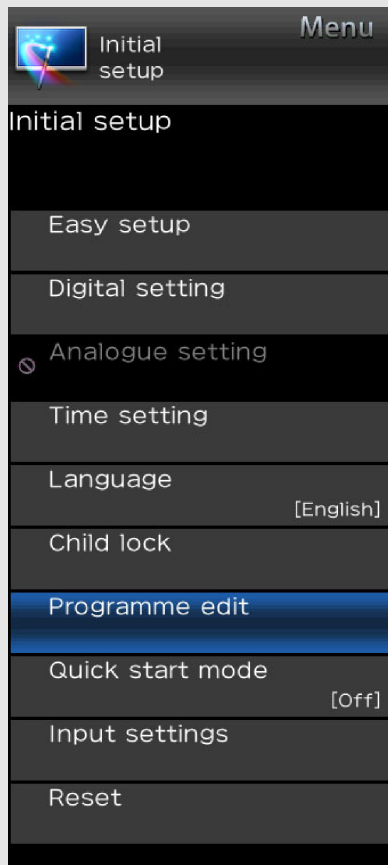

Initial setup (Continue)

Programme edit

Use this menu to set up a channel individually.

Erase: Channels can be erased individually. Press \wedge / \vee to select "Yes" or "No", and then press **ENTER** to erase the selected channel.

Label: You can change channel names individually. Maximum 5 alphanumerics can be input. Press **ENTER** to start labelling. Press \wedge / \vee to select a character, press $<$ / $>$ to select next character, and then press **ENTER** to save.

Sort: Channel position can be sorted freely.

Skip: Channels can be skip by select "Off" or "On".

NOTE

- "Label" is available only for ATV channel.



Example



Initial setup (Continue)

Quick start mode

When this function is activated, you can reduce the TV's start-up time or even let the TV in standby mode start displaying images and so on via the connected equipment on the network. (Off, On)

NOTE

- Setting "Quick start mode" to "On" consumes more power.

Example

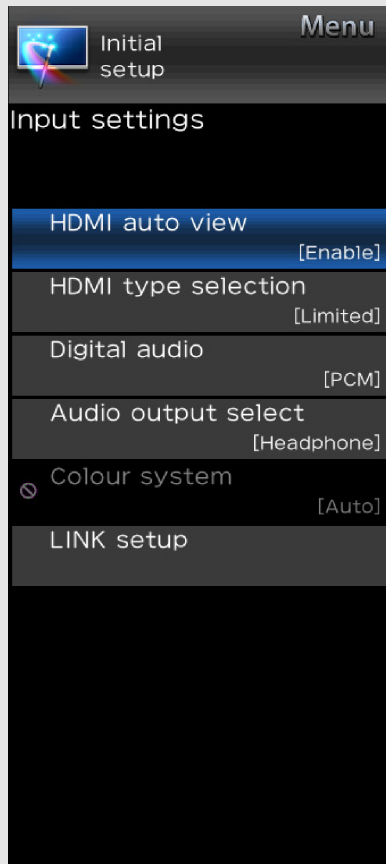

Initial setup (Continue)

Input settings

HDMI auto view

When you view images sent from external equipment in an HDMI connection, this function allows the image size on the TV to automatically switch to an appropriate one. (Enable, Disable)

HDMI type selection

Sets the HDMI type for HDMI INPUT 1 and 2 terminals. Set to "Full" when an HDMI 4K60P 4:4:4 device is connected, and set to "Limited" when an HDMI 4:2:0 device is connected.

Digital audio

This function allows you to select the digital audio signal type.

Off: No selection.

Bitstream: To multi-Channel Dolby Digital.

PCM: To stereo audio system.

Audio output select

You can select which device is used for outputting audio.

Headphone: Output audio through headphones.

Audio out: Output audio through an A/V receiver or surround audio controller.

NOTE

- If you select "Headphone" when a cable is inserted in the AUDIO output terminal, the TV speakers are muted and all Audio menu items cannot be adjusted except for Balance.
- If you select "Audio out", sound via the AUDIO output terminal is not adjustable and constantly outputs.

CAUTION

- AUDIO output terminal is also used for headphones. Reduce the volume before using headphones. Overwhelming sound may damage your hearing.

Colour system

Select the video signal system compatible with your equipment from the list below:

Auto, PAL, SECAM, NTSC 3.58, NTSC 4.43, PAL-60.

NOTE

- "Colour system" can only be set for the VIDEO IN.

Example

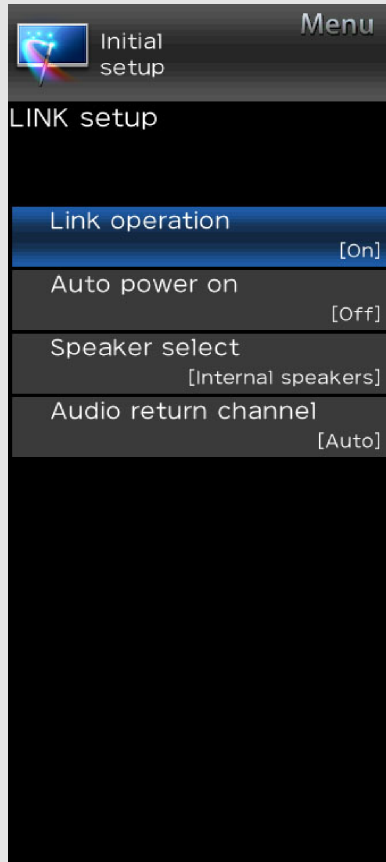

Initial setup (Continue)

Input settings

LINK setup

Link operation

Using the HDMI CEC (Consumer Electronics Control) protocol, with Link operation you can interactively operate compatible system equipment (e.g. DVD), by connecting the link operation-compatible devices with HDMI-certified cables to the TV. Link operation allows you to operate the HDMI-connected equipment and the TV by using a single remote control unit. (Off, On)

Auto power on

If this is activated, the one touch play function is enabled. While the TV is in standby mode, it automatically turns on and plays back the image from the HDMI source. (Off, On)

Speaker select

You can select to listen to the TV sound only from the LINK-compatible audio system. (Internal speakers, External device)

Audio return channel

If this function is set to "Auto", the TV can send audio data for video content shown on the TV to a connected audio device with just one ARC-compatible cable. Using this function eliminates the need to use a separate digital or analogue audio cable. (Off, Auto)

Connection for using "Audio return channel"

You need to use ARC-compatible cables/devices and connect to the HDMI 1 terminal to activate this function.

NOTE

- The ARC (Audio return channel) function works only when using the HDMI 1 terminal.
- When you use an audio system compatible with the ARC function of the TV, you do not need to connect an optical audio cable to the TV.

Example



Initial setup (Continue)

Reset

If complex adjustments are made and the settings cannot be restored to normal, you can reset the settings to the factory preset values.

- If you have already set the password, enter it here.

NOTE

- If you execute “Reset”, all the settings such as “Picture settings”, “Audio settings” and “Initial setup” will be reset to the factory preset values.

Example



Information

Identification

You can check the current version of the software on the screen.

Software update

This is used to upgrade the system software to enhance the TV functions.

Manual update

Select the method for manually updating the software.

USB update: Updates the software using a USB memory device containing the update file. (See pages 4-19 to 4-21 for details on the "Updating the Software via the USB Memory device".)

Network update: Downloads the update file via the network and then updates the software. (See page 4-21 for details on the "Updating the Software via the Network".)

NOTE

- A broadband connection and Internet Setup are required to update the software using the network. (See pages 8-4 to 8-6.)
- It may take time to access and download the update depending on the Internet connection and other factors.

Example

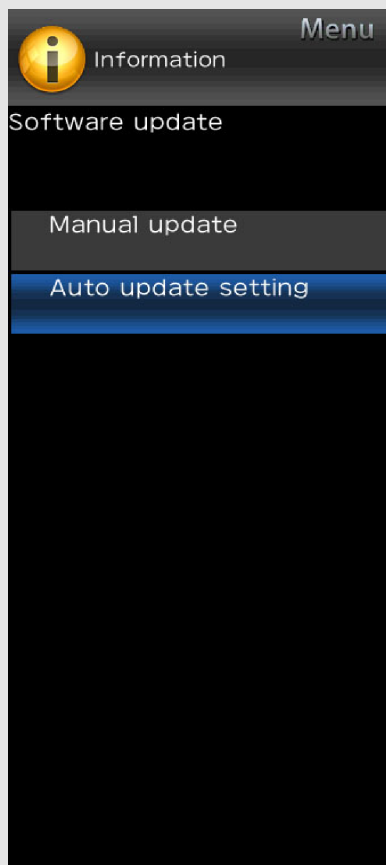

Information (Continue)

Software update

Auto update setting

OAD update

- This function is for automatically download the data for the version update software over digital broadcasts when the “OAD update” is set to “On”.
- To download, follow the instructions when the download message appears during a digital broadcast.
- Once the software upgrade is done, the TV will automatically go to standby state with Red LED.

OAD scan

- This function is for manually download the data for the version update software over digital broadcasts.

CAUTION

- **Do not disconnect the AC cord when the software upgrade is in progress, as this may cause the upgrade to fail. If problem arises ask a qualified service personnel before the software upgrade period expires.**

Network update

When the TV is on, or when an Internet application is being accessed, this function enables the TV to connect to the network and check for updates automatically.

When an update is available, a message is displayed.

Press </> to select "Yes", and then press **ENTER** to display the download screen.

[\(See page 4-21.\)](#)

NOTE

- This function does not work when a broadband connection or Internet Setup is not available.
- A message may also be displayed when an application is running. The message varies depending on the application.

Example



Information (Continue)

Software license

You can read the software license on the screen.

SHARP Terms of Use

You can read the SHARP Terms of Use on the screen.

SHARP Privacy Policy

You can read the SHARP Policy on the screen.

Manual

Displays the built-in operation manual on the screen. You can read information about how to use this device.

Example

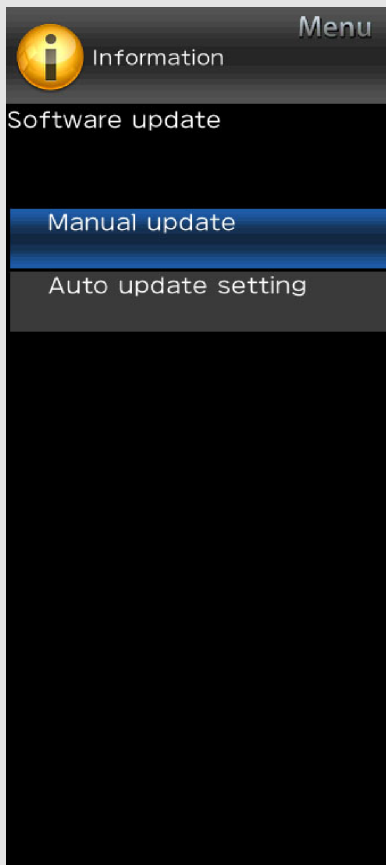

Information (Continue)

Software update

Manual update

Updating the Software via the USB Memory device

1. Insert the USB memory device with the update file into the USB terminal on the TV.

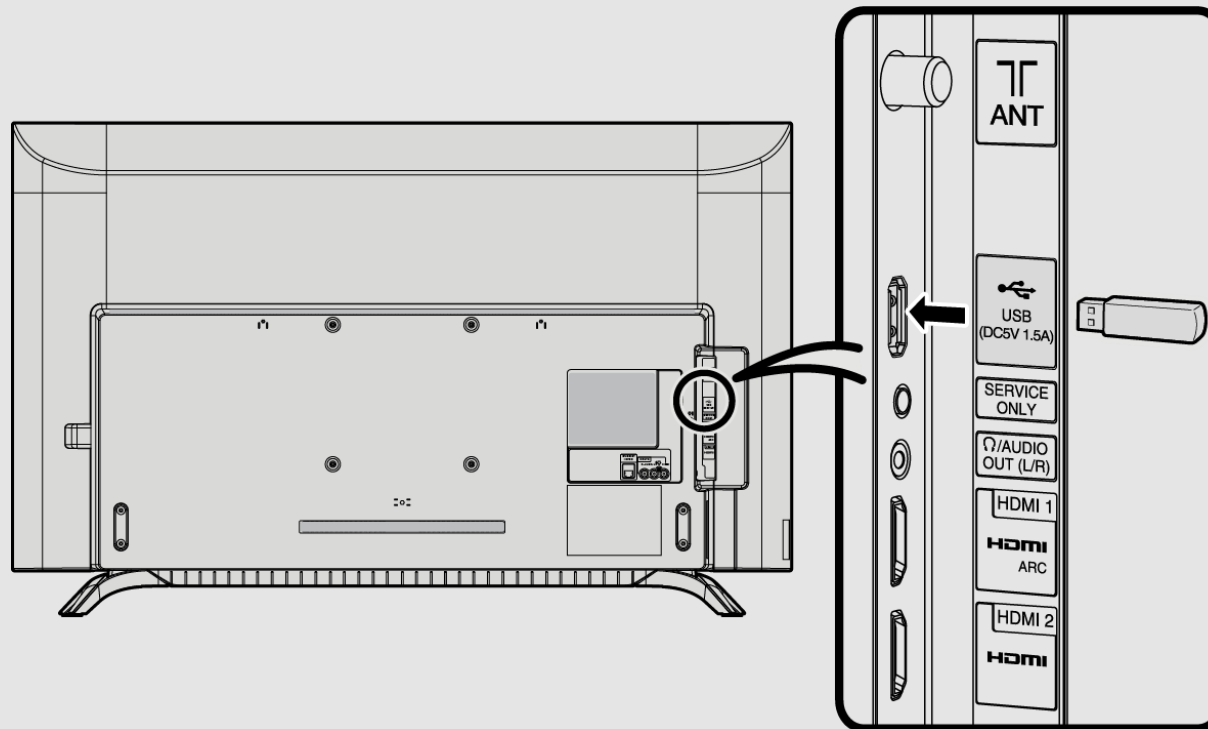

Example

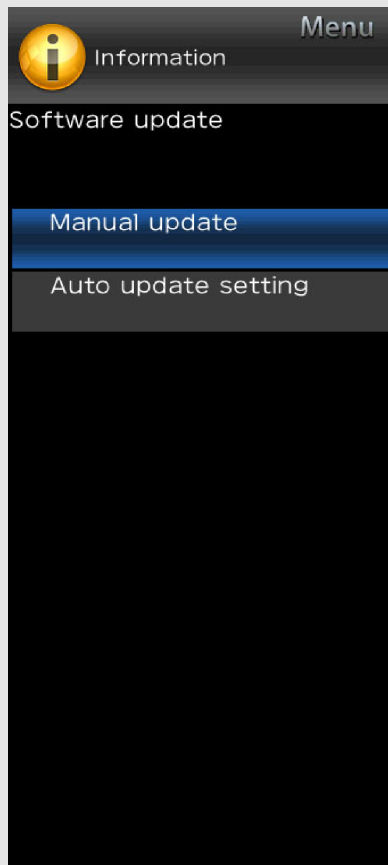

Information (Continue)

Software update (Continue)

Manual update (Continue)

2. Press \wedge / \vee on the Manual update screen to select "USB update", and then press **ENTER**.
3. Press **ENTER** to start checking the data in the USB memory device.

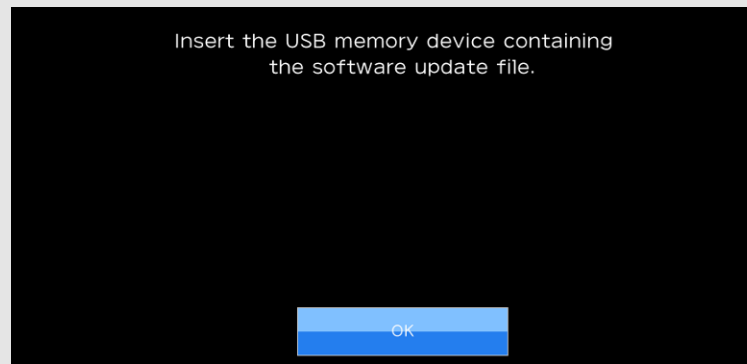

4. Press **ENTER** again and the TV will update software.
 - If the USB memory device is not properly installed or the correct update file cannot be found on the USB memory device, an error message is displayed. Check the file on the USB memory device, and then reinsert the USB memory device correctly.

Example

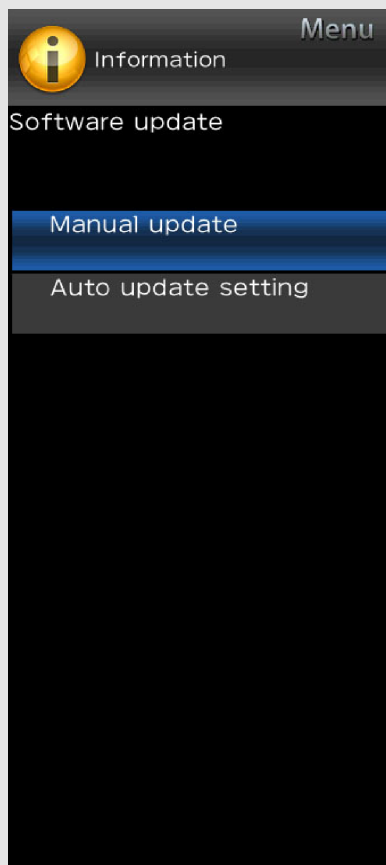

Information (Continue)

Software update (Continue)

Manual update (Continue)

CAUTION

- Do not remove the USB memory device or unplug the AC cord while the software is being updated.
- Be sure to properly follow the whole procedure described below, step by step. Otherwise, for example, the TV cannot read the data in the USB memory device and software updating will fail.

5. When the software is successfully updated, a screen is displayed indicating that the update process is completed.

After this screen is displayed, the TV automatically turns off and then turns on again.

- If the update has failed, check the file in the USB memory device and try Software update again.

6. Remove the USB memory device.

Updating the Software via the Network

1. Press \wedge / \vee on the Manual update screen to select "Network update", and then press **ENTER**.

- The TV connects to the network and checks for updates.
- To cancel, press **ENTER**.

2. The current version of the TV and the latest version of software are displayed. To update the TV software, select "Yes", and then press **ENTER**.

- When a server connection cannot be established or an update is not available, a message is displayed.

If a server connection cannot be established, check the broadband connection and Internet Setup.

3. After the update file is downloaded, the software update process begins.

CAUTION

- Do not unplug the AC cord while the software is being updated.

4. When the software is successfully updated, a screen is displayed indicating that the update process is completed.

A screen indicating that the update is completed is displayed. 4 seconds later, the TV restarts automatically.

- If the software was not updated successfully, check the broadband connection and Internet setup, and then try updating the software again.

Example

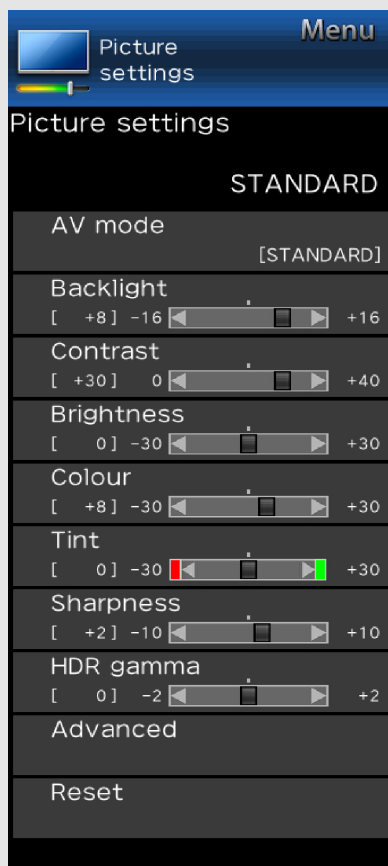

Picture settings

Adjusts the picture to your preference with the following picture settings.

NOTE

- For operating the on-screen display menu, [see page 4-3](#).

Selected item	< button	> button
Backlight	The screen dims	The screen brightens
Contrast	For less contrast	For more contrast
Brightness	For less brightness	For more brightness
Colour	For less colour intensity	For more colour intensity
Tint	Skin tones become reddish	Skin tones become greenish
Sharpness	For less sharpness	For more sharpness
HDR gamma	For less HDR gamma	For more HDR gamma

- For resetting all Picture settings items to the factory preset values, press \wedge / \vee to select "Reset", press **ENTER**, press \wedge / \vee to select "Yes", and then press **ENTER**.
- HDR gamma is available only when receiving HDR signal.

AV mode (Changing Pic.Quality)

AV Mode gives you several viewing options to choose from to best match the surrounding environment of the TV, which can vary due to factors like room brightness, type of programme watched or the type of device connected.

These settings will be automatically saved on each input for convenience.

STANDARD: For a highly defined image in a normal lighting.

MOVIE: For a movie.

PC: For PC.

USER: Allows you to customise settings as desired. You can set the mode for each input source.

DYNAMIC: For a clear-cut image emphasising high contrast, useful for sports viewing.

DYNAMIC (Fixed): Changes the image and sound settings to the factory preset values. No adjustments are allowed.

SUPER ECO: Reduce backlight brightness to save power consumption.

NOTE

- You can select AV mode by pressing **AV MODE** on the remote control unit.

Example

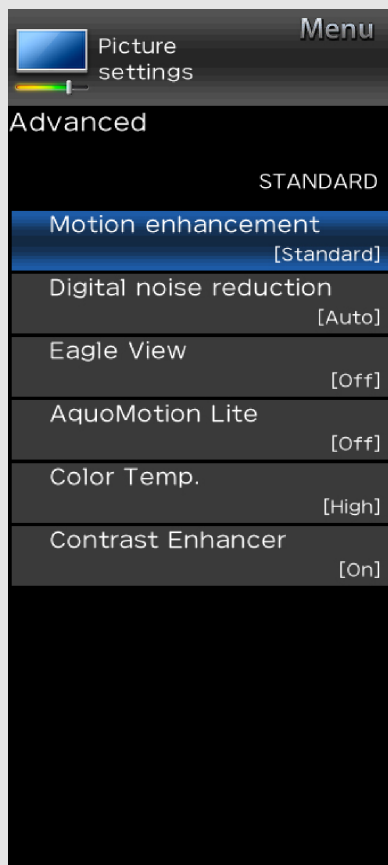

Picture settings (Continue)

Advanced

Motion enhancement

Use Motion enhancement to view fast-action video more clearly. (Off, Standard, Advance)

NOTE

- "Motion enhancement" may cause image noise. If this occurs, turn the function "Off".

Digital noise reduction

Produces a clearer video image.

Off: No adjustment.

Low/Medium/High: You can select a desired level for viewing a clearer video image.

Auto: Automatically adjusts the level of noise reduction.

Eagle View

"Eagle View" technology produces a sharp picture from the original moving picture. (Off, On)

AquoMotion Lite

"AquoMotion Lite" technology provides superior solutions for display picture quality removing motion blur. (Off, High, Advance)

NOTE

- This effect is greater on fast moving images.
- If images appear blurred or flickering, set to "Off".

Color Temp.

Adjusts the colour temperature to give the best white image.

Item	
High	White with bluish tone.
Mid-High	Intermediate tone between "High" and "Middle".
Middle	Natural tone.
Mid-Low	Intermediate tone between "Middle" and "Low".
Low	White with reddish tone.

Contrast Enhancer

Enhance the image for greater contrast. (Off, On)

Example



Audio settings

You can adjust the sound quality to your preference with the following settings.

NOTE

- For operating the on-screen display menu, [see page 4-3](#).

Selected item	< button	> button
Treble	For weaker treble	For stronger treble
Bass	For weaker bass	For stronger bass
Balance	Decrease audio from the right speaker	Decrease audio from the left speaker

NOTE

- For resetting all Audio settings items to the factory preset values, press \wedge / \vee to select "Reset", press **ENTER**, press \wedge / \vee to select "Yes", and then press **ENTER**.

Surround

The surround function produces Surround effect from the speakers.

NOTE

- For some discs, setup may be required on your BD/DVD player. In this case, please refer to the operation manual of your BD/DVD player.

Bass enhancer

This function allows you to enjoy bass-enhanced sound.

Off: Outputs the normal sound.

On: Bass enhancer function is on.

NOTE

- If distorted bass sound is heard, set to "Off".

Auto volume

Different sound sources sometimes do not have the same loudness level, such as a programme and its commercial breaks. The Automatic Volume Control (Auto Volume) reduces this problem by equalizing.

Off: No adjustment.

On: Reduces the loudness gaps among different sound source. The result is automatically adjusted according to the sound sources.

Example



Smart TV

Dashboard

You can display a list of the main Smart TV settings.

Internet Setup

Configures LAN and Internet settings.
[\(See pages 8-4 to 8-6.\)](#)

AQUOS Remote Control

Set this function when operating the TV from equipment connected by LAN or wireless LAN.
[\(See page 7-1.\)](#)

WakeOn Wifi/LAN

Enable the TV to be started by a signal over a Wifi/LAN.

NOTE

- The setting will automatically turn ON when first time using YouTube and it will remain ON until you change it.
- Standby power consumption will be increase when WakeOn Wifi/LAN is turned ON.

Standby Clock Display

TV display time and date information when TV in standby mode.

NOTE

- This feature only available in TV with internet connected and Digital broadcast.
- User can choose either pre-install images or photo from USB act as the background.
- Images will rotate every 30 seconds.
- User need to set the folder name as "CLK" in order to read the image in USB.
- To improve realistic viewing, user need to insert the picture which equal or more than 1920 x 1080 pixels.
- "Data source" can only be selected when "Standby Clock Display" set to "On".

Screen Mirroring

Enjoy favourite content and apps in large screen from smartphone through wireless connection.

NOTE

- User need to key in the pin number generate by the TV to operate screen mirroring.

Example



Smart TV (Continue)

Bluetooth setup

Bluetooth

This feature enable a TV to connect with other Bluetooth devices via Bluetooth connection.

Off: "Paired devices" and "Add accessory" does not work when Bluetooth is set to "Off".

On: Bluetooth function is on.

NOTE

- When you use the Bluetooth device with your TV for the first time, you must make pairing between the device and the TV (Add accessory). Once the pairing is correctly carried out, the Bluetooth device will be registered on the TV (Paired devices).
- Connectivity and reception range may depend on condition, environment and distance of Bluetooth devices.
- Sound quality and compatibility are depend on Bluetooth devices.
- The Bluetooth format only supports HID, A2DP and AVRCP.

Paired devices

You can pair, unpair or forget the device for Bluetooth devices.

Add accessory

The TV will start searching list of Bluetooth devices.

NOTE

- Before pairing operation between devices and TV is completed, enter the PIN code by using the software keyboard (If necessary). When audio output device is connected, you can set the "Speaker type" between "External speaker" and "Subwoofer".
 - External speaker: Audio output at external speaker only. During this setting, "Audio settings" of TV are no available.
 - Subwoofer: Audio output at TV speaker and Subwoofer. User can change Subwoofer behaviour suit the user preference (Bass, Audio delay).
- Lip sync error may occur depends on Bluetooth device and signal source.

RECOMMENDATION

- We recommended you to use CP-SW60A1 SHARP Subwoofer to get better performance.

Example

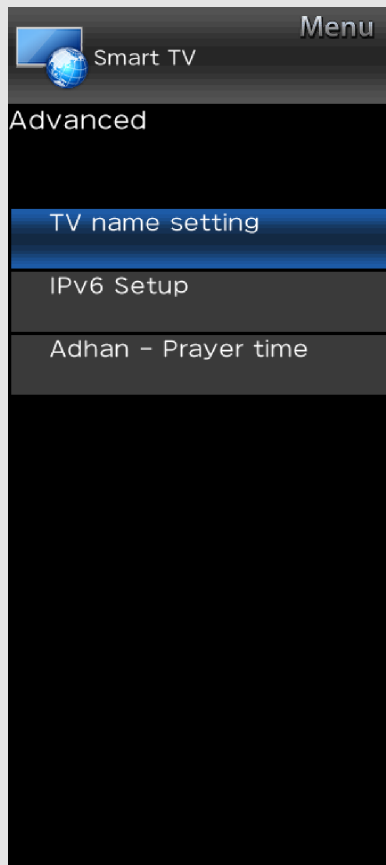

Smart TV (Continue)

Advanced

TV name setting

Set this function when operating the TV from equipment connected by LAN or wireless LAN.
[\(See page 7-1.\)](#)

Use the software keyboard when you need to input text at TV name setting.

Software Keyboard

**ABC**

Switches character to uppercase. If "abc" is pressed again, switches character to lowercase.

":&12"

Changes character set into the alphabet, numbers, symbols, etc.

OK

Applies the entered information and closes the software keyboard.

space

Enters a space.

<--

Erases the character string.

Example

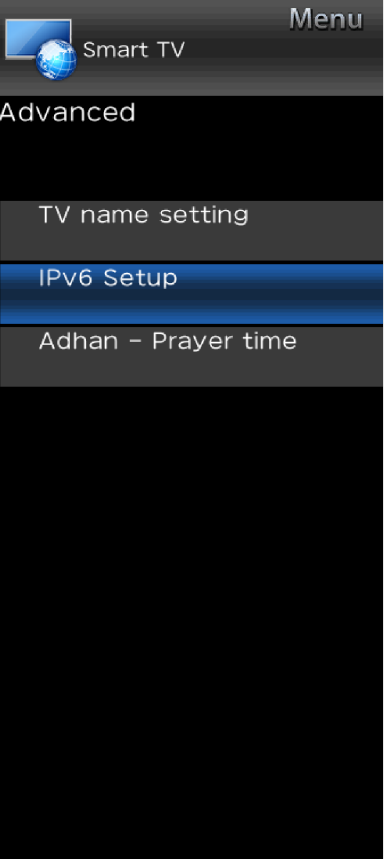

Smart TV (Continue)

Advanced (Continue)

IPv6 Setup

IPv6 (Internet Protocol version 6) is the newest version of Internet Protocol (IP), the communications protocol that provides an identification number and location for each of the world's internet-connected devices.

Wired: Select "Auto" to set the address automatically. Otherwise, select "Manual".

Example

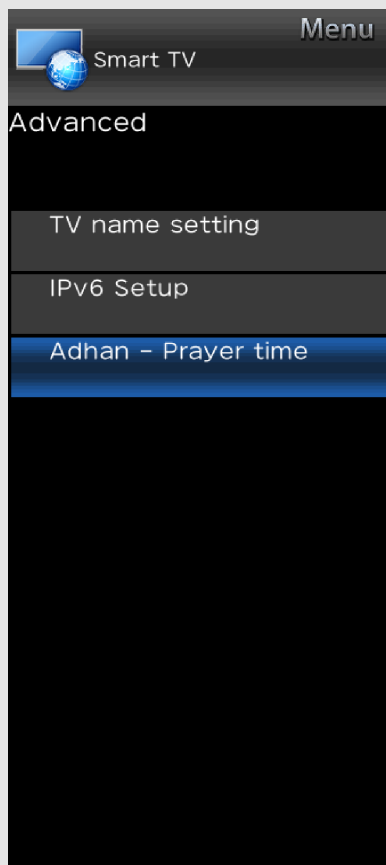

Smart TV (Continue)

Advanced (Continue)

Adhan - Prayer time

This feature could help a Muslim user to stay on top of Prayers with Adhan by getting the accurate prayer times via notification. By configuring location and time zone, all five times prayer will be calculated according to the pointed calculation method.

Auto setup: This function allows you to select the address configuration through pre-set data. (Country, Province, City)

Manual setup: You can insert manually all informations in the screen.

Prayer time selection: You can select or deselect between 5 prayers for Adhan notification.

Notification: You can select or deselect prayer time to notify and enable or disable prayer alert.

Info: A quick reference for you to get info on five times prayer after setup completed.

NOTE

- The notification will be displayed on the screen for 5 minutes. After 5 minutes, the notification screen will be off automatically.
- The notification is based on the setting in Prayer time selection.
- Press ← (**BACK**) to off the notification screen immediately.
- This selection only available when country selected are Malaysia and Indonesia.
- The TV and Adhan time information prior to internet connection.
- The TV time information from digital TV signal will be used if internet connection is not available.
- Deviation of the TV and Adhan display time may occur due to improper digital broadcast standard.

Example

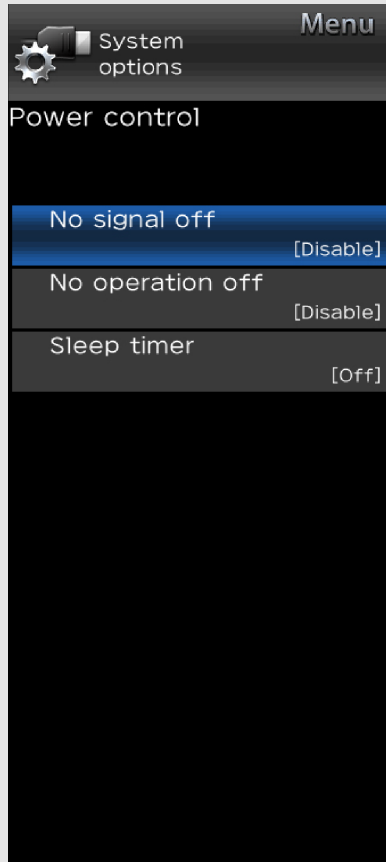

System options

NOTE

- For operating the on-screen display menu, [see page 4-3.](#)

Power control

Power control setting allows you to save energy.

No signal off

When this function is enabled, the TV automatically shuts down if no signal is received for more than 15 minutes.

NOTE

- When it is 5 minutes before the power shuts down, the remaining time will start to keep appearing every minute.
- When a TV programme finishes, this function may not operate.

No operation off

When you enable this function, the TV automatically shuts down if no operation is performed for more than 3 hours. (Disable, 3 hours, 30 min.)

NOTE

- When it is 5 minutes before the power shuts down, the remaining time will start to keep appearing every minute.

Sleep timer

Allows you to set a time when the TV automatically switches to standby.

- The remaining time displays when the sleep timer has been set.
- Set the Sleep timer.

Off → 0hr. 30min. → 1hr. 00min.
 ↑ ↓
 2hr. 30min. ← 2hr. 00min. ← 1hr. 30min.

- When set, the time automatically starts counting down.
- When it is 5 minutes before the time expires, the remaining time will start to keep appearing every minute.

NOTE

- The TV will enter standby when the remaining time reaches 0.

Example

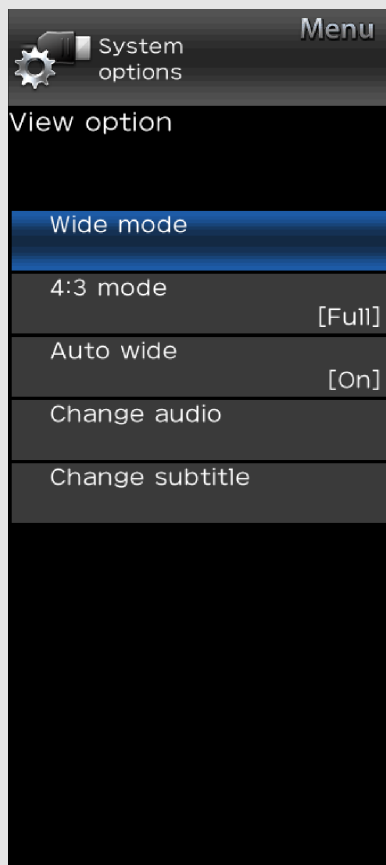

System options (Continue)

View option

Wide mode

This function changes the screen size. Select "View option" on the menu to display the Wide mode menu screen.

The Wide mode menu varies depending on the input source.

For HD programmes

Full: Displays with an overscan image. Crops all sides of screen.

Dot by Dot: Displays an image with the same number of pixels on the screen when receiving HD signals only.

NOTE

- When using Dot by Dot, it is possible to see noise or bars around different outer portions of the screen. Please change wide mode to correct this.
- This feature is available with TV, HDMI IN 1-2, and Video input. Availability in other input modes varies according to the individual App specifications.
- Some items do not appear depending on the type of received signal.

For 4:3 programmes

Normal: Keeps the original aspect ratio in a full screen display.

Full: For 16:9 squeeze pictures.

Cinema 16:9: For 16:9 letterbox pictures. Bars may appear on the top and bottom with some programmes.

Cinema 14:9: For 14:9 letterbox pictures. Bars may appear on the top and bottom with some programmes.

Zoom 14:9: For 14:9 letterbox pictures. A thin side bar appears on each side, and you may also see bars on the top and bottom with some programmes.

Panorama: In this mode, the picture is stretched toward each side of the screen. The picture may appear similar to "Full" depending on broadcast signals.

For PC

Normal: Keeps the original aspect ratio in a full screen display.

Full: An image fully fills the screen.

Dot by Dot: Detects the resolution of the signal and displays an image with the same number of pixels on the screen.

NOTE

- Connect the PC before making adjustments. See the Setup Guide.

Example

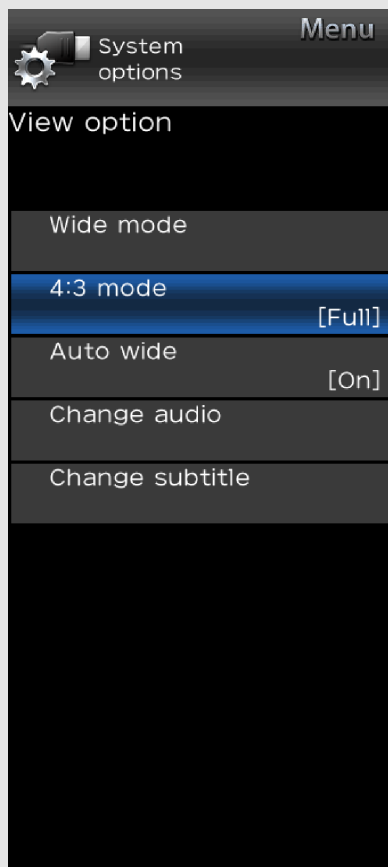

System options (Continue)

View option (Continue)

4:3 mode (DTV and HDMI only)

The 4:3 mode allows you to select between "Normal" and "Full".

Normal: Normal range keeping 4:3 or 16:9 aspect ratio.

Full: Wide image without side bars.

Auto wide (DTV only)

The "Auto wide" allows the TV to switch automatically among the different picture size. (Off, On)

NOTE

- Use "Wide mode" if an image does not switch to the appropriate picture size. When the broadcast signal contains no aspect ratio information, the function will not work even if enabled.

Change audio

MPX

Allows you to change the audio when multiple audio is available for the programme you are watching. (Auto, Mono)

NOTE

- You can change Audio by pressing **AD/MPX** on the remote control unit. [See page 3-4](#) for details of Audio function.

Bilingual

Select from among 3 kinds of mode: **DUAL I**, **DUAL II** and **DUAL I + II**.

Example

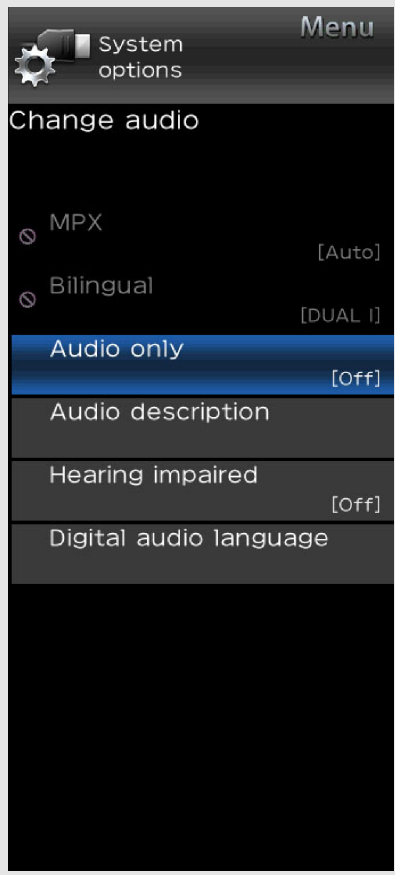

System options (Continue)

View option (Continue)

Change audio

Audio only
When listening to music from a music programme, you can turn the screen off and enjoy audio only.

- Off:** Both screen images and audio are output.
- On:** Audio is output without screen image.

NOTE

- The screen image will return to normal when a button (except those for audio adjustment, such as **VOL**, **MUTE**) is presses.

Audio description (DTV only)
This function allows you to adjust volume output of audio description if the TV receives a signal including audio description.

Switching the multi audio languages
Each time you press **AD/MPX** on the remote control, the audio language switches.

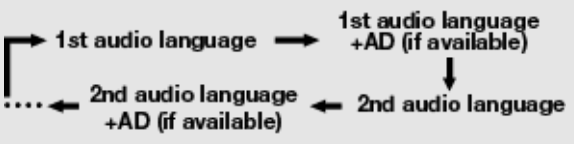

NOTE

- This function is valid only if broadcaster is transmitting audio description.

Hearing impaired (DVB subtitle)

Each time you select "Subtitle" in HOME screen, the subtitle switches when the broadcast contains subtitle information.

Set "Hearing impaired" to "On"

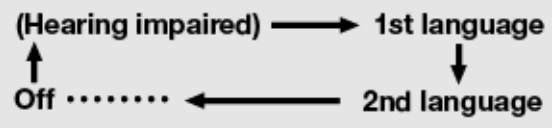

Set "Hearing impaired" to "Off"

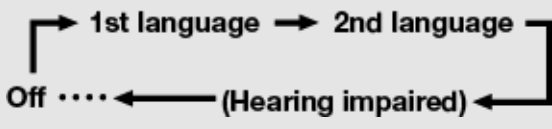

NOTE

- This function is valid only if broadcaster is transmitting multilingual subtitles.

Digital audio language

Set up to two preferred multi audio languages to display if the audio languages are available. (1st language, 2nd language)

NOTE

- If audio for the selected languages is not included in a received broadcast, audio will not be output for that language.

Example

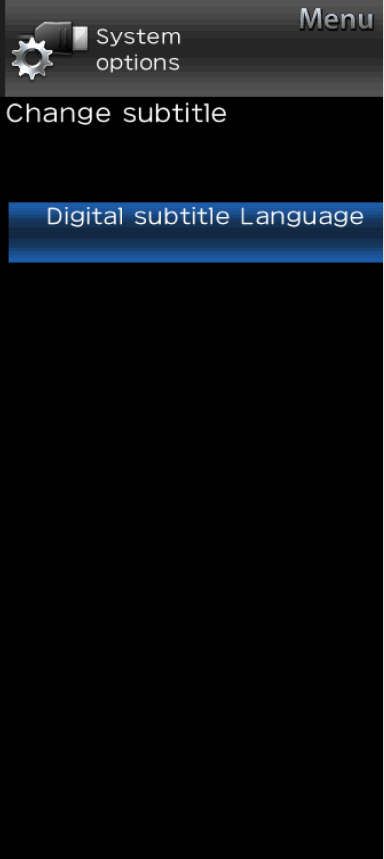

System options (Continue)

View option (Continue)

Change subtitle

Digital subtitle Language

You can display subtitles for the hearing impaired in the Teletext broadcast if the subtitle languages are available.
(1st language, 2nd language)

NOTE

- If subtitles for the selected language are not included in a received broadcast, subtitles will not be shown for that language.

Example

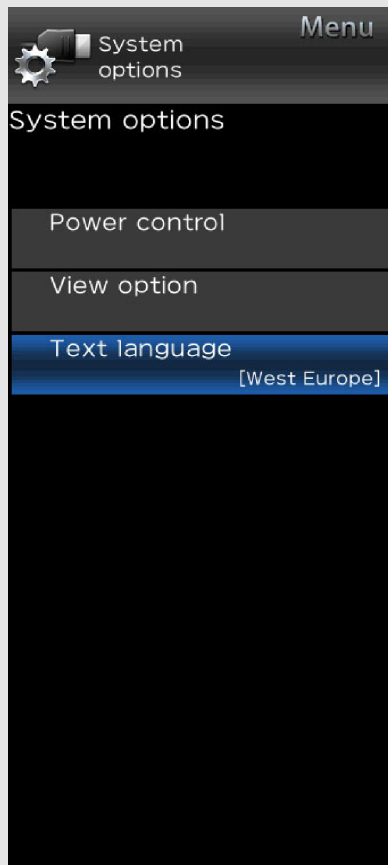

System options (Continue)

Text language

If Teletext information does not display correctly, perform the procedure below. Select from among five kinds of language tables: West Europe, East Europe, Cyrillic, Arabic and Farsi.

Each table is compatible with the Teletext languages listed below.

- West Europe — English, French, Scandinavian, Turkish, German, Spanish, Italian
- East Europe — Polish, French, Scandinavian, Czech, German, Slovenian/Croatian, Italian, Rumanian
- Cyrillic — English, Russian, Estonian, Czech, German, Slovenian/Croatian, Ukrainian, Lettish
- Arabic — English, French, Scandinavian, Turkish, German, Hebrew, Italian, Arabic
- Farsi — English, French, Scandinavian, Turkish, German, Hebrew, Italian, Farsi

NOTE

- Teletext can be displayed only when it is sent by a network. Not used to convert between languages.

Example

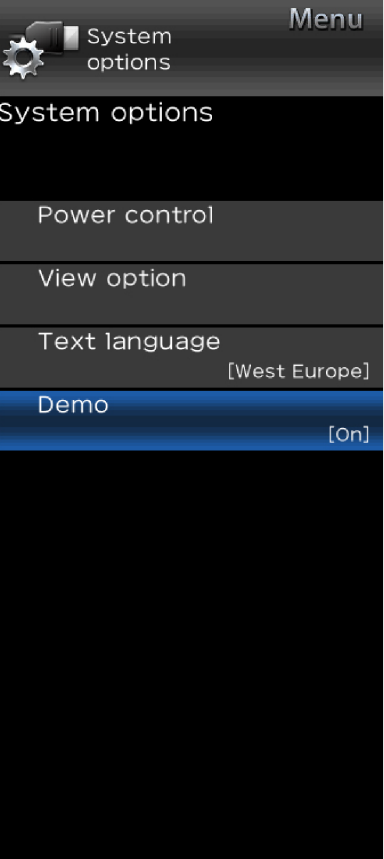

System options (Continue)

Demo (store mode only)

When "Store mode" is set to "On", after all the settings are completed, the Feature demo screen is displayed if there is no operation for 30 seconds.

Preparation

You can connect the TV to a USB memory device, USB hard drive or Home Network server to enjoy viewing pictures, listening to music, and watching videos.

NOTE

- Depending on the USB memory device/USB hard drive/Home Network server, the TV may not be able to recognise the recorded data.
- It may take time to read the recorded data if the USB memory device/USB hard drive/Home Network server contains many files or folders.
- Use only alphanumeric characters for naming files.
- File names over 80 characters (may vary depending on character set) may not be displayed.

Connecting a USB Memory Device/USB Hard Drive

Insert the USB memory device with recorded photos, music or videos into the USB terminal on the TV.

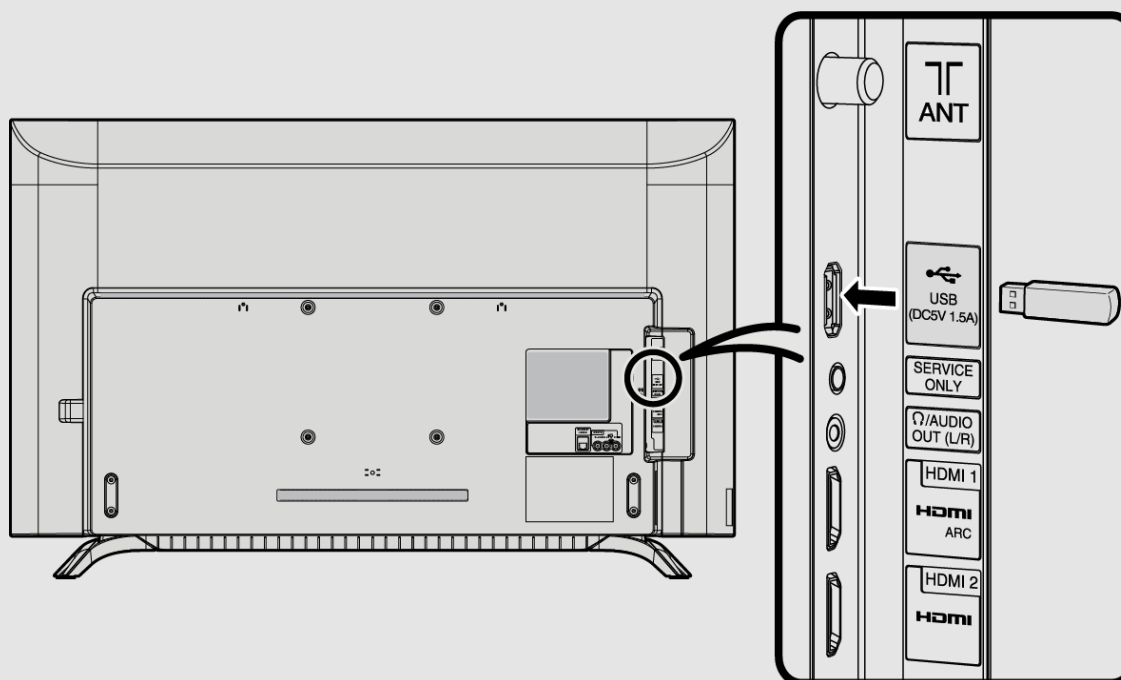

Preparation (Continue)

- When connecting a USB hard drive, be sure to use a hard drive with an AC adapter.
- Do not remove a USB memory device or memory card from the TV while transferring files, using the slide show function, or switching screens, or before you exit "USB" from the INPUT list.
- Do not insert and remove a USB memory device/USB hard drive to and from the TV repeatedly.
- When using a card reader, be sure to insert a USB memory device first.

CAUTION

- **Do not use a USB extension cable when connecting a USB memory device to the USB terminal on the TV.**
- **Using a USB extension cable with the USB memory device may prevent the TV from performing correctly.**

Connecting a Home Network Server

Connect the TV to the Home Network server using an ETHERNET cable.

- You can also connect a Home Network server by using a wireless LAN.

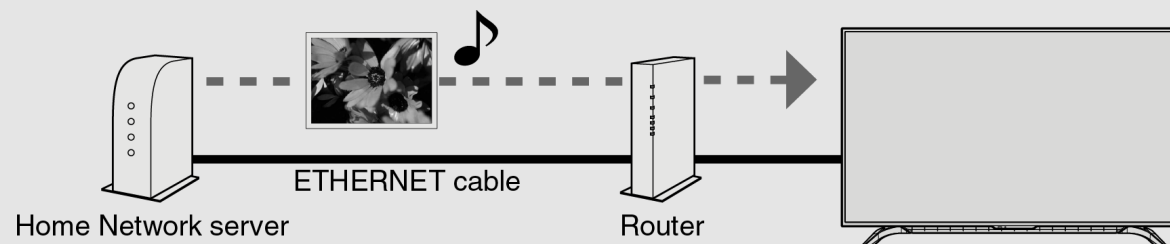
**NOTE**

- Do not disconnect a Home Network server from the TV while transferring files, when a screen is switching to another or before you exit "Home network" from the HOME screen.
- Do not connect and disconnect a Home Network server from the TV repeatedly.



USB Media Player

- To play back data on a USB memory device, insert the USB memory device on the TV.
1. Select "USB" in "Input" or "Home network" in "Smart" from HOME screen.

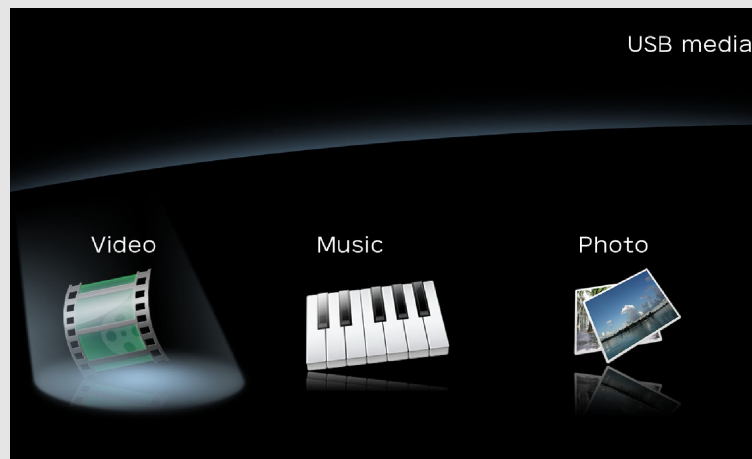

2. Press </> to select "Video", "Music" or "Photo", and then press **ENTER**.
3. Press </> to select your USB directory, and then press **ENTER**.
4. Press ^/v/</> to select the desired folder, and then press **ENTER**.

NOTE

- "Wide mode" is fixed during "Photo" and "Music".
- Depending on the USB device, the TV may not be able to recognise the contained data.
- A file name with more than 10 characters may not be displayed all (depending on the character set).
- Files in USB 1.1 devices may not be played properly.
- Operation using USB hubs is not guaranteed.
- The compatibility of USB HDDs may not be guaranteed.
- USB only support device up to DC5V 1.5A.



Selecting the Folders to Play Back

NOTE

- If the TV is turned off and then on again, the number assigned to the USB may change.

USB Device Compatibility

USB device	USB Memory
File system	FAT32, NTFS*

Photo file format

Format	JPEG (.jpg)/PNG/BMP)
--------	----------------------

Music file format

Format	Bitrate [KHz]
MP3	32k, 40k, 48k, 56k, 64k, 80k, 96k, 112k, 128k, 160k, 192k, 224k, 256k, 320kbps

* Not guarantee for all devices.



Selecting the Folders to Play Back (Continue)

Video file format

Container	Video	Audio
AVI	H.264 MPEG4 Motion Jpeg	Dolby Digital Plus LPCM ADPCM Dolby Digital
MKV	H.264 MPEG4	Dolby Digital Plus MPEG Dolby Digital
MP4	H.264 MPEG4 Motion Jpeg	Dolby Digital Plus MPEG Dolby Digital
MPEG2 – PS	MPEG2	LPCM Dolby Digital
MPG MPEG	MPEG2 MPEG1	LPCM MPEG Dolby Digital
TS	H.264 MPEG2	Dolby Digital Plus LPCM MPEG Dolby Digital

NOTE

- Progressive format jpeg files are not supported.
- USB 1.1 devices may not be played properly.
- Operation using USB hubs is not guaranteed.
- Some video file formats may not be played depending on the file.
- Some images may not be displayed in the appropriate aspect ratio depending on the file format.
- File extensions are not used to determine the file format.

Home Network Server Compatibility

Photo file format	JPEG
Music file format	LPCM, MP3
Video file format	AVI, MP4, MPG

NOTE

- Progressive format jpeg files are not supported.
- Some video file formats may not be played depending on the file or the server.

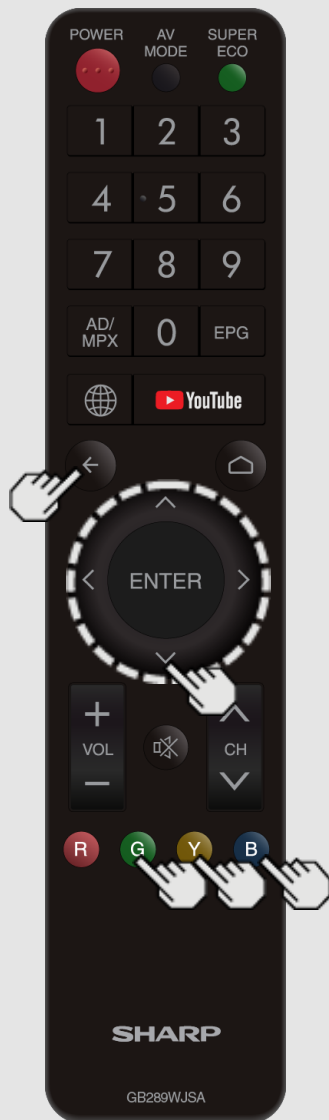

Playing Back Files on a USB Memory Device/Home Network Server

Control panel for Photo/Music/Video mode operations

- Press **B** to display the control panel below.

Button/menu	Description	Photo	Music	Video
ENTER	When selecting a folder icon: Enter this directory. When selecting a thumbnail: Play the selected file.	✓	✓	✓
	Play/Pause.	✓	✓	✓
	Rewind. Each time you press rewind, the speed will change (2x, 4x, 8x, 16x).	-	✓	✓
	Fast-forward. Each time you press fast-forward, the speed will change (2x, 4x, 8x, 16x).	-	✓	✓
*G /	Play the previous file.	✓	✓	✓
*Y /	Play the next file.	✓	✓	✓
	Stop playback and return to the list of files.	✓	✓	✓
	Loop. Each time you press ENTER , the mode will switch between Repeat 1 → Repeat All → Repeat None	✓	✓	✓
	Play/cancel the background music.	✓	-	-
	Mute. Press ENTER to toggle between mute and unmute.	-	✓	✓
	Two loop. Press ENTER to set the current playback time starting point. Press ENTER to set the loop end of the current playing time and start loop playback. Press ENTER button to cancel the loop.	-	-	✓
	Slow-forward. Each time you press slow-forward, the speed will change.	-	-	✓

NOTE

- * The button **G** and **Y** does not work during control panel display.
- Files in folder which are not related to a selected mode cannot be accessed.
- "Unsupport file" alert will pops up for a selected file of invalid format.

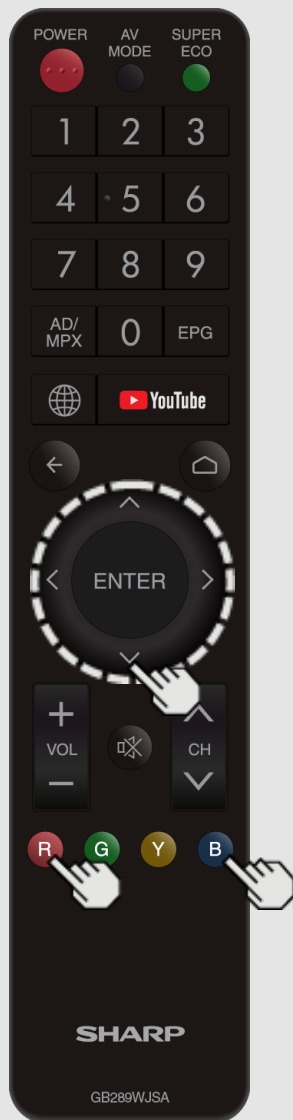

Playing Back Files on a USB Memory Device/Home Network Server (Continue)

Control panel for Photo/Music/Video mode operations (Continue)

- Press **B** to display the control panel below.

Button/menu	Description	Photo	Music	Video
	Step-forward. Each time you press ENTER , the picture will change to the next still picture.	-	-	✓
	Rotate clockwise 90°.	✓	-	-
	Rotate counterclockwise 90°.	✓	-	-
	Zoom in an image. Select to display larger image size.	✓	-	-
	Zoom out an image. Select to display smaller image size.	✓	-	-
	Select playback length of a slideshow.	✓	-	-
	Select photo display interval.	✓	-	-
	Slide effect.	✓	-	-
R	Select subtitle to On or Off subtitle.	-	-	✓

NOTE

- Files in folder which are not related to a selected mode cannot be accessed.
- “Unsupport file” alert will pops up for a selected file of invalid format.

Controlling HDMI Equipment Using LINK Operation

What's LINK Operation?

- Using the HDMI CEC (Consumer Electronics Control) protocol, with LINK Operation you can interactively operate compatible system equipment (Blu-ray disc equipment, AV amplifier, DVD).
- By connecting LINK-compatible devices with HDMI-certified cables to the TV, you can control a recorder or AV amplifier using the remote control of the TV.
- LINK Operation allows you to operate the HDMI-connected equipment with one remote control.

NOTE

- For connecting the TV to LINK-compatible equipment, use commercially available cables.
- Point the remote control toward the TV, not to connected HDMI equipment.
- Video noise may occur depending on the type of HDMI cable used. Make sure to use an HDMI-certified cable.
- Up to 3 pieces of HDMI recording equipment and one AV amplifier can be connected using this system.

NOTE

- If the equipment does not operate, turn on the equipment and select the appropriate input source using  (HOME).
- The LINK feature may not operate properly when an HDMI splitter or AV selector unit is used. These devices may cause interruptions to the image and/or sound.

Connected LINK-compatible devices can be operated without changing the settings of the remote control unit.

One Touch Play

While the TV is in standby mode, it automatically turns on and plays back the image from the HDMI source.

Single remote control

The LINK Operation automatically recognises the connected HDMI device and you can control the TV and the devices as if using a universal remote control.

Control the LINK-compatible audio system

Set the volume of LINK-compatible audio system.

NOTE

- The above description is an example of the LINK Operation function.
- Refer to this operation manual and the operation manual of the LINK-compatible device to be used with this TV.

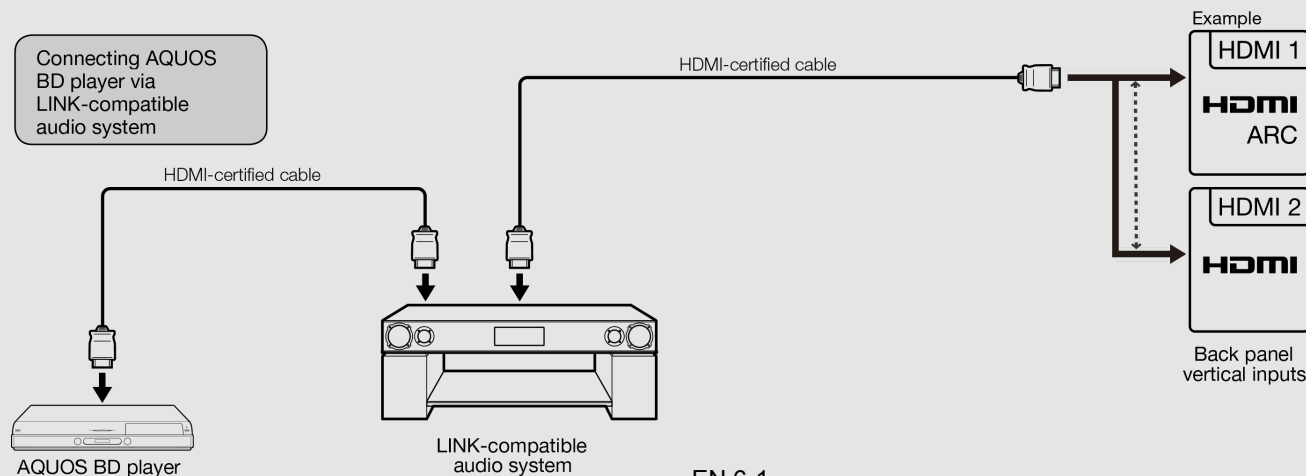

EN 6-1

Control of the TV

- The TV can be controlled from a PC, control panels and other devices using the RS-232C. (at 'SERVICE ONLY' terminal)
- Use a cross-type RS-232C cable (commercially available) for the connections and conversion cable to minijack. (can purchase from service center)

NOTE

- This operation system should be used by a person who is accustomed to using computers.

AQUOS Remote Control

Set this function when operating the TV from equipment connected by LAN or wireless LAN. To perform the operation, refer to "Smart TV" > "AQUOS Remote Control".

AQUOS Remote Control

When "AQUOS Remote Control" is selected, "Change" will be highlighted. Press **ENTER**.

Detailed Settings

Make the detailed settings (Login ID, password).

Follow the on-screen instructions to configure the settings.

Device Name

Set the name of the TV displayed on other network devices.

Configure the settings from "  (HOME)" > "Settings" > "Menu" > "Smart TV" > "Advanced" > "TV name setting".

Communication Conditions for RS-232C

Set the RS-232C communication settings on the PC to match the TV's communication conditions.

The TV's communication settings are as follows:

Baud rate:	115,200 bps
Data length:	8 bits
Parity bit:	None
Stop bit:	1 bit
Flow control:	None

Communication procedure

Send the control commands from the PC via the RS-232C.

The TV operates according to the received command and sends a response message to the PC.

Do not send multiple commands at the same time.

Wait until the PC receives the OK response before sending the next command.

Control of the TV (Continue)

Command format

Eight ASCII codes +CR

C1	C2	C3	C4	P1	P2	P3	P4	↵
----	----	----	----	----	----	----	----	---

Command 4-digits Parameter 4-digits Return code

Command 4-digits: Command. The text of four characters.

Parameter 4-digits: Parameter 0-9, x, blank, ?

Parameter

Input the parameter values, aligning left, and fill with blank(s) for the remainder. (Be sure that 4 values are input for the parameter.)

When the input parameter is not within an adjustable range, "ERR" returns. (Refer to "Response code format".)

Any numerical value can replace the "x" on the table.

0				When "?" is input for some commands, the present setting value responds.	?			
0	0	0	9		?	?	?	?
-	3	0						

Response code format

Normal response

O	K	↵
---	---	---

Return code (ODH)

Problem response

(communication error or incorrect command)

E	R	R	↵
---	---	---	---

Return code (ODH)

Command table

- Commands not indicated here are not guaranteed to operate.

CONTROL ITEM		COMMAND				PARAMETER				CONTROL CONTENTS	
POWER SETTING		P	O	W	R	0	-	-	-	Power Off	It shifts to standby.
						1	-	-	-	Power On	Power On
INPUT SELECTION	TOGGLE	I	T	G	D	-	-	-	-	(Toggle)	It input-switches by the toggle. (It is the same as an input change key)
	TV	I	T	V	D	-	-	-	-		It input-switches to TV. (A channel remains as it is. (Last memory))
	0-4	I	A	V	D	*	-	-	-	0: TV, 1: HDMI 1, 2: HDMI 2, 3: VIDEO IN, 4: USB	

NOTE

- If an underbar (_) appears in the parameter column, enter a space.
- If an asterisk (*) appears, enter a value in the range indicated in brackets under CONTROL CONTENTS.
- Any numerical value can replace the "x" on the table.

Control of the TV (Continue)

CONTROL ITEM	COMMAND				PARAMETER				CONTROL CONTENTS	
AV MODE SELECTION	A	V	M	D	*	-	-	-	0: (Toggle), 1: STANDARD, 2: MOVIE, 4: USER, 5: DYNAMIC, 6: DYNAMIC (Fixed), 7: PC, 8: SUPER ECO	Although it can choose now, it is toggle operation in inside.
VOLUME	V	O	L	M	*	*	*	-	Volume (0-100)	

CONTROL ITEM	COMMAND				PARAMETER				CONTROL CONTENTS	
WIDE MODE	W	I	D	E	*	*	-	-	0: (Toggle), 1: Normal, 2: Zoom 14:9, 3: Panorama, 4: Full, 5: Cinema 16:9, 6: Cinema 14:9, 7: Normal (PC), 9: Full (PC), 10: Dot by Dot, 11: Underscan, 12: Auto (USB), 13: Original (USB)	It is the same as Wide Mode key.
MUTE	M	U	T	E	*	-	-	-	0: (Toggle), 1: On, 2: Off	

NOTE

- If an underbar (_) appears in the parameter column, enter a space.
- If an asterisk (*) appears, enter a value in the range indicated in brackets under CONTROL CONTENTS.
- Any numerical value can replace the "x" on the table.

Control of the TV (Continue)

CONTROL ITEM	COMMAND				PARAMETER				CONTROL CONTENTS
SURROUND	A	C	S	U	*	-	-	-	0: (Toggle), 1: On, 2: Off
AUDIO SELECTION	A	C	H	A	-	-	-	-	(Toggle)
SLEEP TIMER	O	F	T	M	*	-	-	-	0: Off, 1: OFF TIMER - 30 MIN., 2: OFF TIMER - 60 MIN., 3: OFF TIMER - 90 MIN., 4: OFF TIMER - 120 MIN., 5: OFF TIMER - 150 MIN.
TELETEXT	T	E	X	T	0	-	-	-	TEXT OFF
	T	E	X	T	1	-	-	-	(Toggle)
CHANNEL	D	C	C	H	*	*	-	-	TV DIRECT CHANNEL (1-99)
	I	D	T	V	-	-	-	-	An input change to DTV

NOTE

- If an underbar (_) appears in the parameter column, enter a space.
- If an asterisk (*) appears, enter a value in the range indicated in brackets under CONTROL CONTENTS.
- Any numerical value can replace the "x" on the table.

Control of the TV (Continue)

CONTROL ITEM		COMMAND				PARAMETER				CONTROL CONTENTS	
CHANNEL	CH UP	C	H	U	P	-	-	-	-	The channel number of TV +1	If it is not TV display, it will input-switch to TV. (same function as CH ^)
	CH DOWN	C	H	D	W	-	-	-	-	The channel number of TV -1	If it is not TV display, it will input-switch to TV. (same function as CH v)
DEVICE NAME		T	V	N	M	1	-	-	-		The device name set in "Device Name" is displayed.
MODEL NAME		M	N	R	D	1	-	-	-		The model name of the TV.





CONTROL ITEM	COMMAND				PARAMETER				CONTROL CONTENTS	
SOFTWARE VERSION	S	W	V	N	1	-	-	-		The current version of the TV software is displayed.
IP PROTOCOL VERSION	I	P	P	V	1	-	-	-		The currently supported version of IP protocol is displayed.

NOTE

- If an underbar (_) appears in the parameter column, enter a space.
- If an asterisk (*) appears, enter a value in the range indicated in brackets under CONTROL CONTENTS.
- Any numerical value can replace the "x" on the table.

Control of the TV (Continue)

CONTROL ITEM	COMMAND				PARAMETER				CONTROL CONTENTS
	R	C	K	Y	*	*	-	-	
REMOTE CONTROL BUTTONS									0-9: 0-9, 12: POWER, 13: DISPLAY, 15: ◀▶, 16: ▶▶, 17: ▶▶▶, 18: ▶▶▶▶, 19: ▶▶▶▶▶, 20: ■, 21: ▶▶▶▶▶, 24: SLEEP, 28: AV MODE, 29: WIDE, 30: ⏮ (FLASHBACK), 31: MUTE, 32: VOL -, 33: VOL +, 34: CH ▲, 35: CH ▼, 36: INPUT, 38: MENU, 39: HOME, 40: ENTER, 41: ▲, 42: ▼, 43: ▶, 44: ◀

CONTROL ITEM	COMMAND				PARAMETER				CONTROL CONTENTS
	R	C	K	Y	*	*	-	-	
REMOTE CONTROL BUTTONS									45: RETURN, 49: MPX, 50: R (red), 51: G (green), 52: B (blue), 53: Y (yellow), 61: MANUAL, 64:  SUBTITLE, 65:  TELETEXT, 66: GUIDE, 68:  HOLD, 71: INFO, 72:  REVEAL/HIDDEN, 82: RADIO, 83: EPG, 84: YouTube, 85: BROWSER

NOTE

- If an underbar (_) appears in the parameter column, enter a space.
- If an asterisk (*) appears, enter a value in the range indicated in brackets under CONTROL CONTENTS.
- Any numerical value can replace the "x" on the table.

PC Compatibility Chart

It is necessary to set the PC correctly to display XGA and WXGA signal.

Resolution		Horizontal Frequency	Vertical Frequency	VESA Standard
VGA	720 x 400	31.5 kHz	70 Hz	—
	640 x 480	31.5 kHz	60 Hz	○
		37.9 kHz	72 Hz	○
		37.5 kHz	75 Hz	○
SVGA	800 x 600	35.1 kHz	56 Hz	○
		37.9 kHz	60 Hz	○
		48.1 kHz	72 Hz	○
		46.9 kHz	75 Hz	○
XGA	1024 x 768	48.4 kHz	60 Hz	○
		56.5 kHz	70 Hz	○
		60.0 kHz	75 Hz	○
WXGA	1360 x 768	47.7 kHz	60 Hz	○
SXGA	1280 x 1024	64.0 kHz	60 Hz	○
SXGA+	1400 x 1050	65.3 kHz	60 Hz	○
1080p	1920 x 1080	67.5 kHz	60 Hz	—

VGA and XGA are registered trademarks of International Business Machines Corp.

Connecting to the Internet

By connecting your TV to a broadband system, you can access the Internet from the TV.

- You can enjoy a variety of streaming content and Internet applications.
- It is necessary to configure the network settings in order to enjoy streaming content and internet applications.

These settings can be configured from "🏠 (HOME)" > "Settings" > "Menu" > "Smart TV" > "Internet Setup".

NOTE

- To connect your TV to the Internet, you must have a broadband Internet connection.
- If you do not have a broadband Internet connection, consult the store where you purchased your TV or ask your Internet service provider or telephone company.
- When an Internet connection is made, an Ethernet and wireless connection cannot be used at the same time. Use only one of the connection types.

Using an ETHERNET cable

Use an ETHERNET cable (commercially available) to connect the ETHERNET terminal on the TV to your broadband router (commercially available).

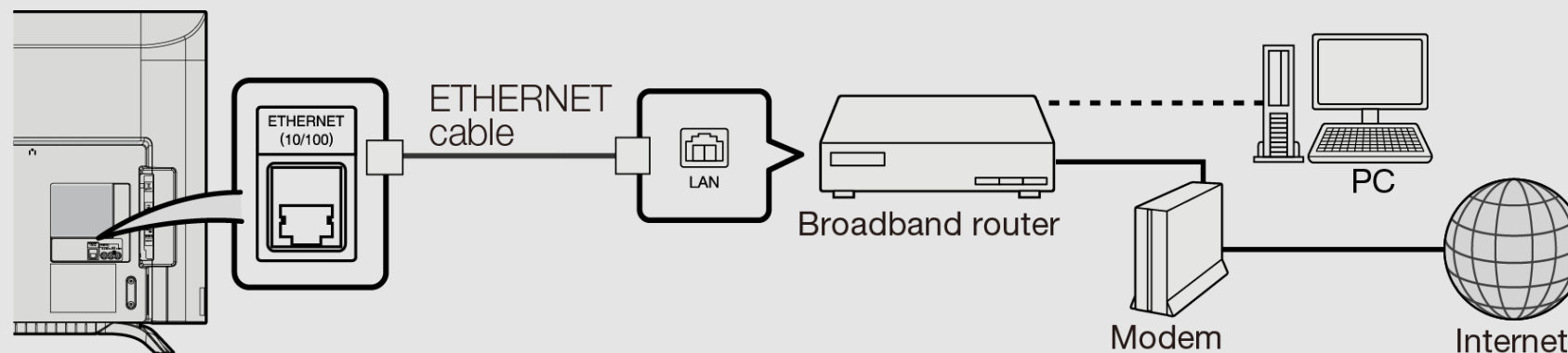

Connecting to the Internet (Continue)

Using the wireless LAN

This TV is equipped with a wireless LAN function.



For a wireless LAN connection, you must use wireless setup to connect the access point and TV.

**NOTE**

- This TV has a built-in wireless LAN function. Using a separate wireless USB LAN adapter may result in radio communications that do not comply with regulations on radio communications. Therefore, do not use a separate wireless LAN adapter.
- A wireless LAN connection and performance cannot be guaranteed for all residential environments. In the following cases, the wireless LAN signal may be poor or drop, or the connection speed may become slower.
 - When used in buildings made with concrete, reinforced steel, or metal
 - When placed near objects that obstruct the signal
 - When used with other wireless devices that emit the same frequency
 - When used in the vicinity of microwave ovens and other devices that emit a magnetic field, electrostatic charge, or electromagnetic interference
- Operations cannot be guaranteed when used with access points that do not have Wi-Fi® certification.

Connecting to the Internet (Continue)

NOTE

















- A wireless LAN router/access point is required to connect the TV to the Internet using a wireless LAN. See the operation manual of your access point for setup.
- If your access point is set to a stealth mode (that prevents detection by other devices), you may not be able to establish a connection. In this case, disable the stealth mode on the access point.
- A stable connection speed is required to play back streaming content. Use an Ethernet connection if the wireless LAN speed is unstable.
- Before transferring to a third party or disposal, be sure to initialize the wireless LAN settings.
- Please follow the legislation in your country when using the wireless LAN outdoors.
- If you have failed to connect to the Internet in the above operation, then an error message will appear. In this case, press  (HOME) to exit from the connected TV feature to make changes to the network settings.
- If you still cannot connect to the Internet, please consult your Internet service provider or telephone company.
- You cannot configure the settings from " (HOME)" > "Settings" > "Menu" > "Smart TV" > "Internet Setup" while using an application. If you must configure your "Network" settings, press the  (HOME) key to exit the function.



Smart TV

Internet Setup

Perform the procedure below to make adjustments or to confirm the settings for accessing the Internet.

- 1 Press  (**HOME**) to display the HOME screen.
- 2 Press  /  to select "Settings", press , press  /  to select "Internet Setup", and then press **ENTER**.
- 3 Press  /  to select "Internet Setup", and then press **ENTER**.
- 4 Press  /  to select "Connection type", "Wired setup" or "Wireless setup", and then press **ENTER**.
 - Select "Wired setup" or "Wireless setup" when you make general adjustments to connect to the Internet.
- 5 Press  /  to select a specific item, and then press **ENTER**.
- 6 Press  /  /  /  to select the desired setting, and then press **ENTER**.
- 7 Press  (**HOME**) to exit.

Connection type

Select the connection type.

Wired: The signal is detected and setup is performed automatically. Use "Wired setup" to check and change the settings as necessary. [See page 8-5.](#)

Wireless: Configure the access point settings on "Wireless setup". [See page 8-6.](#)



Smart TV (Continue)

Internet Setup (Continue)

Wired setup

You can make adjustments manually for the IP.

- You can switch the "Connect type" to "Auto" or "Manual".
- Check that numbers are displayed for each setting.
- If there are any settings without numbers, specify the numbers by following the on-screen instructions.
- Input the IP address etc by using remote control buttons **0-9**.



Smart TV (Continue)

Internet Setup (Continue)

Wireless setup

Make adjustments and confirm the settings necessary for wireless LAN connection (such as search for the access point and registration of it).

WPS

WPS push button: Allows the TV to automatically establish the connection using a button on the access point.

WPS PIN code: Sets up the connection by registering a PIN code for the access point.

Search: Searches for and selects the access point to be connected.

Manual setup: Allows you to make the connection by entering an SSID for the access point.

If your access point supports Wi-Fi Protected Setup (WPS push button method), it is recommended that you use this function for the wireless connection. You can press the WPS button on the access point to configure the settings automatically.

- The name of the WPS button function may differ depending on the access point. See the operation manual of the access point for details.
1. Confirm the current settings in "Connection type".
 - If "Wired" is selected, press \wedge / \vee to select "Wireless".

2. Select the desired connection method and follow the instructions shown on the display.
3. When a connection is established, the connection details are displayed. Press **ENTER**.

NOTE

- Operations cannot be guaranteed when used with access points that do not have Wi-Fi® certification.
- A wireless LAN router/access point is required to connect the TV to the Internet using a wireless LAN. See the operation manual of your access point for setup.
- If your access point is set to a stealth mode (that prevents detection by other devices), you may not be able to establish a connection. In this case, disable the stealth mode on the access point.
- A stable connection speed is required to play back streaming content. Use an Ethernet connection if the wireless LAN speed is unstable.
- Before transferring to a third party or disposal, be sure to initialize the wireless LAN settings.
- Please follow the legislation in your country when using the wireless LAN outdoors.

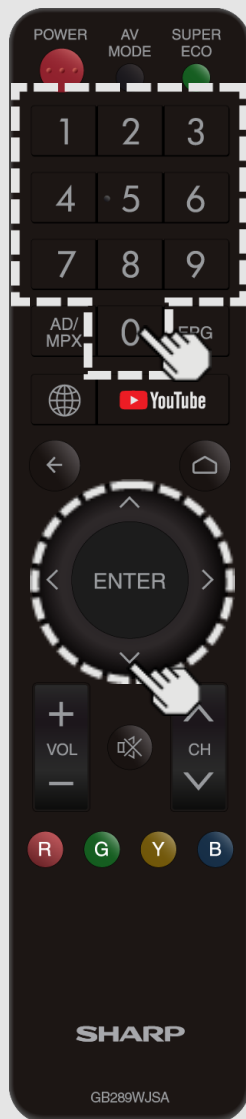

Entering Text (Software Keyboard)

When you are editing an input screen or specifying the Network settings used for accessing the Internet, enter text from the software keyboard.

NOTE

- You can enter up to 128 characters for text.
- Some special characters or diacritics may not be available depending on where you enter the text.

The text you enter is displayed as you type it in.

To move the cursor (the current input position), use "**<-**" or "**->**" on the software keyboard.



While you are entering text, likely input conversion candidates are displayed based on what you typed in.

↑Shift

If "alphabet" is selected, this switches characters between uppercase and lowercase. Each time you press **ENTER**, the character type switches.

⌫

Press **ENTER** to select the type of characters entered: alphabet, or sign.

⌫/Delete

Erases text one character at a time.



Entering Text (Software Keyboard) (Continue)

Enter
Applies the entered information and closes the software keyboard.

Space
Enters a space.

Close
Closes the software keyboard without applying the entered information.

Buttons on the remote control unit	Description
^ / v / < / >	Moves the focus. When moved at the far edge, the focus moves to the opposite edge.
ENTER	Performs the processing for the button currently in the focus.
←	Closes the software keyboard without applying the original input elements for the entered text.

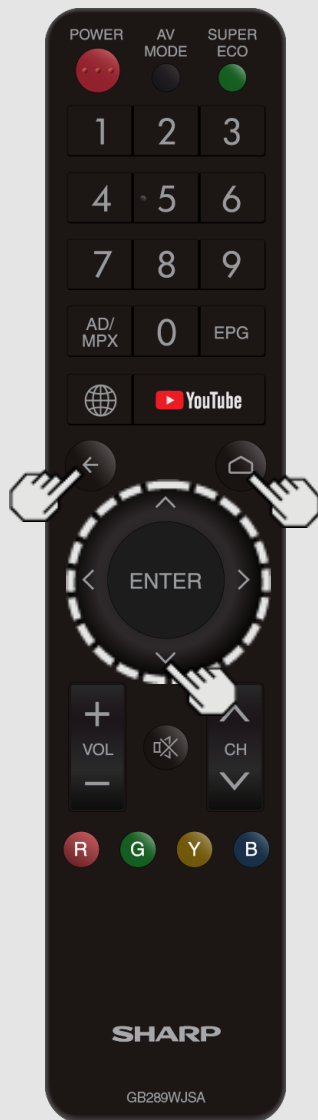

Using the Browser

Press (**HOME**), press to select the browser icon from the application window, and then press **ENTER**.

- Press (**HOME**) again to switch back to the currently tuned channel.

Buttons for Using the Browser

ENTER, ,

- Press , to select a link that you want to jump, and then press **ENTER**.

(**BACK**)

- Press the button to return to the previous page.

NOTE

- Restrictions apply to window display.
- Some website may not able to see properly due to compatibility issue.

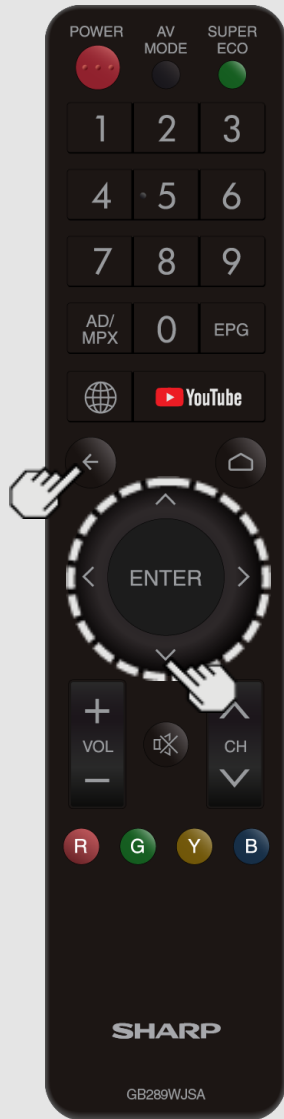

Using the Browser (Continue)



Selected item	Description
	Allows you to go back to the previous page.
	Allows you to go to the next page.
	Displays the home page.
	Refreshes the page. Interrupts a page while it is loading.

Selected item	Description
	Configures browser settings.
	Displays your browsing history.
	Displays the bookmarks list.

Using the Toolbar

You can use the toolbar to control the browser and to specify settings.

- 1 Press **</>** to select a function, and then press **ENTER**.

Browsing Web Contents

You can display the web content you want to enjoy.

- 1 Press **</>** to move to the address area in the toolbar, and then press **ENTER**.
 - The Enter Address menu is displayed.
- 2 Enter an address, and then press **ENTER**.
 - The web content you want to view is displayed.

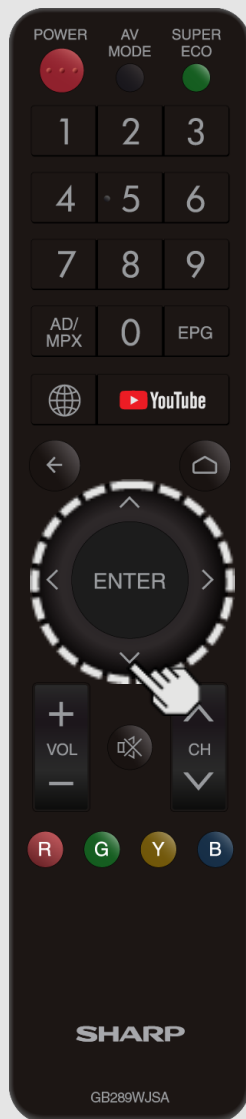

Using the Browser (Continue)

CAUTION

- If the power is cut due to a power failure or the TV being unplugged while you are using the Internet, information such as bookmarks or cookies may not be saved correctly.

To users who access the Internet from a PC

- When you access the Internet from this TV, the procedures may not be the same as regular browser-based access on a PC.
- On some pages, video and audio, text or images may not be displayed correctly.

About links

- Web pages on the Internet often include "links" that allow you to jump to other web pages (or sites).
- "Links" can take various forms, including words or images, but they always work in the same way letting you jump to the link destination when you select them.
- Selected items (such as links of text input fields) are enclosed in a frame.
- You can jump from a "link" to the corresponding link destination.

DISCLAIMERS

SHARP corporation bears no responsibility regarding the content and quality of the content provided by the content serve provider.

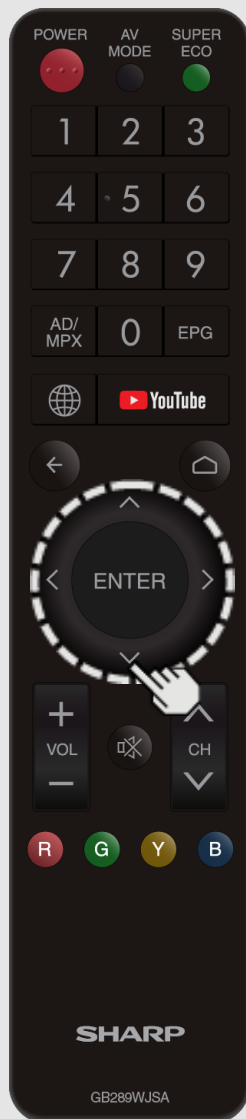

Using the Browser (Continue)

Browser Settings

You can check or modify your browser settings from the Browser menu.

- 1 Press </> to select "  " in the toolbar, and then press **ENTER**.
- 2 Press ^/v/</> to specify the required setting, and then press **ENTER**.



Using the Browser (Continue)

Website Favourite Link

User can create direct website link through

each  icon shown in Home menu.

NOTE

- User need to bookmark the website link at web browser before they can bookmark at Home menu.
- Once bookmark complete by user in web

browser, user can move the cursor to  icon to create direct link at Home menu.



Using Keyboard and Mouse

You can use a keyboard or mouse for operating the TV when using applications.

- When you use the USB devices, connect the device to the USB terminal on the TV.

NOTE

- The keyboard or mouse may not operate properly depending on the application being used.



Using Applications via the Internet

By connecting the TV to the Internet, you can enjoy a variety of broadband content, including videos, music and photos.



Please check that the most current software is loaded on TV by selecting "Auto Update Setting" on "Software Update"
[\(see page 4-17\).](#)

Use the application window to access your favourite Internet applications. Press  (**HOME**) to display the application window.

Follow the on-screen instructions for each application.

- When using this TV to access an Internet application for the first time, the Disclaimer appears on the screen.
 Press \wedge / \vee to select "Agree", and then press **ENTER**. (You must select "Agree" to use the application.)
- Check the web site of the provider for details on setup and use of the functions.

NOTE

- If "" or "" is displayed, check your TV's network settings and connection.
- These applications are provided by content providers. The available applications vary depending on your country or region.
- The delivery speed of applications varies depending on the network speed. Check the web site of the provider for details on application setup and other information.

Troubleshooting

Problem	Possible Solution
<ul style="list-style-type: none"> No power 	<ul style="list-style-type: none"> Check if you pressed POWER on the remote control unit. Is the AC cord disconnected? Has the power been turned on?
<ul style="list-style-type: none"> Unit cannot be operated. 	<ul style="list-style-type: none"> External influences such as lightning, static electricity, may cause improper operation. In this case, operate the unit after first turning off the power of the TV or unplugging the AC cord and replugging it in after 1 or 2 minutes.
<ul style="list-style-type: none"> Remote control unit does not operate. 	<ul style="list-style-type: none"> Is the equipment to be operated by the remote control unit set correctly? Are batteries inserted with polarity (+, -) aligned? Are batteries worn out? (Replace with new batteries.) Are you using it under strong or fluorescent lighting? Is a fluorescent light illuminated near the remote control sensor?
<ul style="list-style-type: none"> Picture is cut off/with sidebar screen. 	<ul style="list-style-type: none"> Are screen mode adjustments such as picture size made correctly? Page 4-31
<ul style="list-style-type: none"> Strange colour, light colour, or colour misalignment 	<ul style="list-style-type: none"> Adjust the picture tone. Pages 4-22 to 4-23 Is the room too bright? The picture may look dark in a room that is too bright.
<ul style="list-style-type: none"> Power is suddenly turned off. 	<ul style="list-style-type: none"> Is the sleep timer set? Page 4-30 Check the power control settings. Page 4-30 The unit's internal temperature has increased. Remove any objects blocking vent or clean.

Problem	Possible Solution
<ul style="list-style-type: none"> No picture 	<ul style="list-style-type: none"> Is connection to other components correct? If the PC image is not displayed, check the following: <ul style="list-style-type: none"> When connecting a laptop PC to the TV, check that display output mode of the PC is set to external monitor. Check the resolution setting on the PC. Is a non-compatible signal being input? Page 7-7
<ul style="list-style-type: none"> Picture quality of HD programmes is poor. 	<ul style="list-style-type: none"> To enjoy HD images from external equipment, you are required to set up HDMI connection or component connection. If the programme content is not of HD quality, HD images cannot be displayed. Check that the programme you are viewing provides HD images. The HD cable/satellite set-top box may need to be configured to output HD images via cable/satellite. The cable/satellite broadcast may not support a signal resolution of 1080p.
<ul style="list-style-type: none"> The TV sometimes makes a cracking sound. 	<ul style="list-style-type: none"> This is not a malfunction. This happens when the cabinet slightly expands and contracts according to change in temperature. This does not affect the TV's performance.

Troubleshooting (Continue)

Problem	Possible Solution
<ul style="list-style-type: none"> No sound 	<ul style="list-style-type: none"> Is connection to other components correct? Is the volume too low? Page 3-2 Have you pressed  (MUTE) on the remote control unit? Page 3-3 Check the audio output of the connected external equipment. Is the volume too low or muted? When external equipment is connected via an HDMI cable, you may need to configure the audio to be output through the HDMI cable. When connecting a PC via an HDMI-certified cable, check the following: <ul style="list-style-type: none"> - Is the audio output of the PC configured correctly? Check the audio output settings and output audio format in Sound Properties on the PC. The audio formats compatible with this TV are PCM, Dolby Digital. With other formats, audio cannot be output.

Troubleshooting - Error Message

The example of an error message displayed on a screen	Possible Solution
<ul style="list-style-type: none">No broadcast now.	<ul style="list-style-type: none">Check the antenna cable. Check that the antenna is correctly setup.Check the broadcast time in the programme guide.
<ul style="list-style-type: none">An incompatible audio signal has been received. Check the output device settings.	<ul style="list-style-type: none">This message is displayed when an audio format other than PCM, Dolby Digital is input.<ul style="list-style-type: none">- Set the audio output format of connected external HDMI equipment to PCM, Dolby Digital.- Refer to the operation manual of the external equipment for setting details.

Information on the Software License for This Product

Software license

You can read the software licenses in the on-screen display menu. Refer to "HOME" > "Settings" > "Menu" > "Information" > "Software license" .

Software composition

The software included in this product is comprised of various software components whose individual copyrights are held by SHARP or by third parties.

Cautions regarding use in high and low temperature environments

- When the unit is used in a low temperature space (e.g. room, office), the picture may leave trails or appear slightly delayed. This is not a malfunction, and the unit will recover when the temperature returns to normal.
- Do not leave the unit in a hot or cold location. Also, do not leave the unit in a location exposed to direct sunlight or near a heater, as this may cause the cabinet to deform and the front panel to malfunction.
Storage temperature: -20°C to +60°C

- Manufactured under license from Dolby Laboratories. Dolby, Dolby Audio, and the double-D symbol are trademarks of Dolby Laboratories.

- The terms HDMI and HDMI High-Definition Multimedia Interface, and the HDMI Logo are trademarks or registered trademarks of HDMI Licensing Administrator, Inc. in the United States and other countries.

- The Wi-Fi CERTIFIED™ Logo is a certification mark of Wi-Fi Alliance®.
- The Wi-Fi Protected Setup™ Logo is a certification mark of Wi-Fi Alliance®.

- The Bluetooth® word mark and logos are registered trademarks owned by the Bluetooth SIG, Inc. and any use of such marks by SHARP Corporation is under license. Other trademarks and trade names are those of their respective owners.

- ANY USE OF THIS PRODUCT IN ANY MANNER OTHER THAN PERSONAL USE THAT COMPLIES WITH THE MPEG-2 STANDARD FOR ENCODING VIDEO INFORMATION FOR PACKAGED MEDIA IS EXPRESSLY PROHIBITED WITHOUT A LICENSE UNDER APPLICABLE PATENTS IN THE MPEG-2 PATENT PORTFOLIO, WHICH LICENSE IS AVAILABLE FROM MPEG LA, LLC, 6312 S. Fiddlers Green Circle, Suite 400 E, Greenwood Village, Colorado 80111 U.S.A.

- THIS PRODUCT IS LICENSED UNDER THE VC-1 PATENT PORTFOLIO LICENSE FOR THE PERSONAL AND NON-COMMERCIAL USE OF A CONSUMER TO (i) ENCODE VIDEO IN COMPLIANCE WITH THE VC-1 STANDARD ("VC-1 VIDEO") AND/OR (ii) DECODE VC-1 VIDEO THAT WAS ENCODED BY A CONSUMER ENGAGED IN A PERSONAL AND NON-COMMERCIAL ACTIVITY AND/OR WAS OBTAINED FROM A VIDEO PROVIDER LICENSED TO PROVIDE VC-1 VIDEO. NO LICENSE IS GRANTED OR SHALL BE IMPLIED FOR ANY OTHER USE. ADDITIONAL INFORMATION MAY BE OBTAINED FROM MPEG LA, L.L.C. SEE [HTTP://WWW.MPEGLA.COM](http://www.mpegla.com)

- THIS PRODUCT IS LICENSED UNDER THE AVC PATENT PORTFOLIO LICENSE FOR THE PERSONAL USE OF A CONSUMER OR OTHER USES IN WHICH IT DOES NOT RECEIVE REMUNERATION TO (i) ENCODE VIDEO IN COMPLIANCE WITH THE AVC STANDARD ("AVC VIDEO") AND/OR (ii) DECODE AVC VIDEO THAT WAS ENCODED BY A CONSUMER ENGAGED IN A PERSONAL ACTIVITY AND/OR WAS OBTAINED FROM A VIDEO PROVIDER LICENSED TO PROVIDE AVC VIDEO. NO LICENSE IS GRANTED OR SHALL BE IMPLIED FOR ANY OTHER USE. ADDITIONAL INFORMATION MAY BE OBTAINED FROM MPEG LA, L.L.C. SEE [HTTP://WWW.MPEGLA.COM](http://www.mpegla.com)

- THIS PRODUCT IS LICENSED UNDER THE MPEG-4 VISUAL PATENT PORTFOLIO LICENSE FOR THE PERSONAL AND NON-COMMERCIAL USE OF A CONSUMER FOR (i) ENCODING VIDEO IN COMPLIANCE WITH THE MPEG-4 VISUAL STANDARD ("MPEG-4 VIDEO") AND/OR (ii) DECODING MPEG-4 VIDEO THAT WAS ENCODED BY A CONSUMER ENGAGED IN A PERSONAL AND NON-COMMERCIAL ACTIVITY AND/OR WAS OBTAINED FROM A VIDEO PROVIDER LICENSED BY MPEG LA TO PROVIDE MPEG-4 VIDEO. NO LICENSE IS GRANTED OR SHALL BE IMPLIED FOR ANY OTHER USE. ADDITIONAL INFORMATION INCLUDING THAT RELATING TO PROMOTIONAL, INTERNAL AND COMMERCIAL USES AND LICENSING MAY BE OBTAINED FROM MPEG LA, L.L.C. SEE [HTTP://WWW.MPEGLA.COM](http://www.mpegla.com)

TV

Item		Model: 4T-C50AH1X	
LCD panel		126 cm	
Resolution		8,294,400 pixels (3840 x 2160)	
Video colour system		PAL/SECAM/NTSC 3.58/NTSC 4.43/PAL 60	
TV Function	TV-standard	Analogue	PAL: B/G, D/K, I SECAM: B/G, D/K, K/K1 NTSC: M
		Digital	DVB-T / DVB-T2
	Receiving Channel	VHF/UHF	44.25—863.25 MHz
		CATV	S1—S41 ch (including Hyperband)
	TV-tuning system	Auto Preset 99 ch	
STEREO/BILINGUAL	NICAM: B/G, I, D/K A2 stereo: B/G MTS: M		
Audio amplifier		10 W x 2	
Terminals	ANT (Antenna input)	UHF/VHF 75 Ω DIN type	
	SERVICE ONLY	Ø3.5 mm jack	
	INPUT 1 (ARC) HDMI	HDMI (HDMI input), ARC	
	INPUT 2 HDMI	HDMI (HDMI input)	
	INPUT 3	AUDIO in, VIDEO in	
	AUDIO OUT	AUDIO out, Headphone (Ø3.5 mm stereo)	
	USB	USB (DC5V 1.5A output)	
	ETHERNET (10/100 BASE-T)	Network connector	
OSD language		English/Simplified Chinese/Arabic/French/Portuguese/Russian/Persian/Thai/Vietnamese/Indonesia/Hebrew/Hindi/Malay	
Power Requirement		AC 110 — 240 V, 50/60 Hz	
Power Consumption		140 W (0.5 W Standby)	
Dimensions	without stand	1122 (W) x 666 (H) x 74 (D) mm	
	with stand	1122 (W) x 708 (H) x 253 (D) mm	
Weight without stand (with stand)		12.0 kg (12.5 kg)	
Operating temperature		0°C to +40°C	

- As a part of policy of continuous improvement, SHARP reserves the right to make design and specification changes for product improvement without prior notice. The performance specification figures indicated are nominal values of production units. There may be some deviations from these values in individual units.
- Specification may differ depending on the selected country.

CAUTION

- Installing the Liquid Crystal Television requires special skill that should only be performed by qualified service personnel. Customers should not attempt to do the work themselves. SHARP bears no responsibility for improper mounting or mounting that results in accident or injury.
- Carefully read the instructions that come with the bracket before beginning work.

Wireless LAN

Specification	
Standard	IEEE 802.11b/g/n
Security	Static WEP (64/128 bit kry index 1 only) WPA-PSK (TKIP) WPA2-PSK (AES)
Modulation	IEEE802.11b: DBPSK, DQPSK, CCK / DSSS HRDSSS IEEE802.11g: BPSK, QPSK, 16QAM, DBPSK, DQPSK, CCK, PBCC / OFDM IEEE802.11n: BPSK, QPSK, 16QAM, 64QAM / OFDM
Throughput	IEEE802.11b: 1, 2.5, 5, 11Mbps IEEE802.11g: 6, 9, 12, 18, 24, 36, 48, 54Mbps IEEE802.11n: ~300Mbps



Dimensional Drawings



4T-C50AH1X

Unit: mm

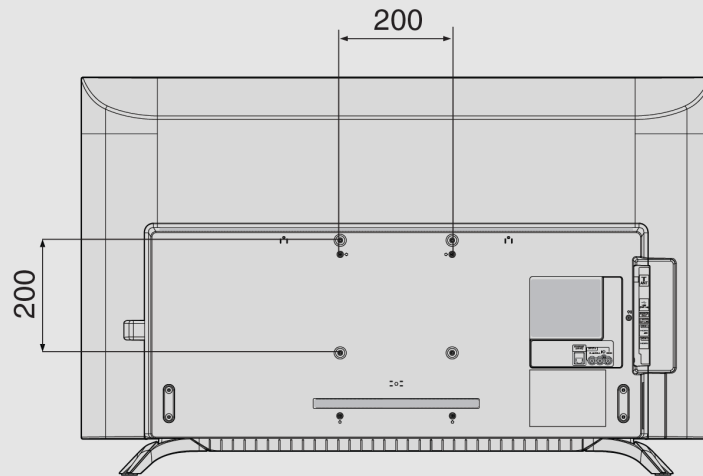
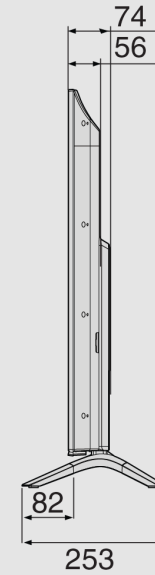
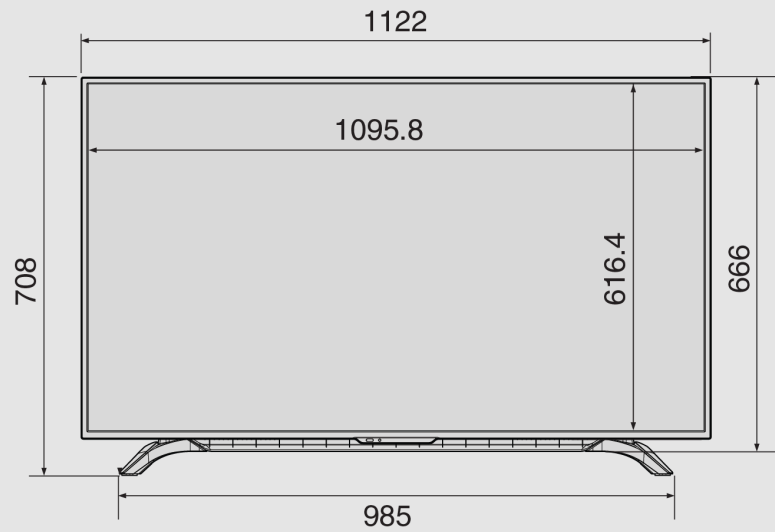

EN 12-1



SHARP[®]
SHARP CORPORATION

ENGLISH | FRANÇAIS | PORTUGUÊS | РУССКИЙ | 中文 | INDONESIA | ภาษาไทย | TIẾNG VIỆT | عربي | АҒЫЛШЫН | O'ZBEK TILIDA