

# SHARP

4T-C50EK2X; 4T-C55EK2X  
4T-C60EK2X; 4T-C65EK2X  
4T-C70EK2X; 4T-C75EK2X  
**LED BACKLIGHT TV**



**HDMI™** **LED** **DVB-T2®** **Dolby Vision·Atmos**

Dear SHARP customer

Thank you for your purchase of the SHARP LCD colour TV product. To ensure safety and many years of trouble-free operation of your product, please read the Important safety precautions carefully before using this product.

## Contents

Safety and warnings.....	1-5
Introduction.....	6
Installation.....	7-10
Wall Mount.....	11
General Description.....	12-14
External Connection.....	15-17
Menu Operations.....	18-26
Trouble Shooting.....	27-28

## SAFETY AND WARNINGS

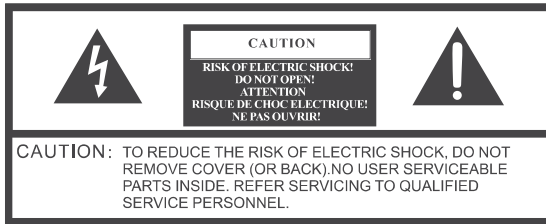

The lightning flash with arrowhead symbol within an equilateral triangle is intended to alert the user to the presence of uninsulated "hazardous voltage" within the product's enclosure, which may be of sufficient magnitude to induce a risk of electric shock to persons.



The exclamation point within an equilateral triangle is intended to alert the user to the presence of important operating and maintenance (servicing) instructions in the literature accompanying the appliance.

**WARNING:** TO PREVENT FIRE OR SHOCK HAZARD, DO NOT EXPOSE THIS APPLIANCE TO RAIN OR MOISTURE.  
TO PREVENT THE SPREAD OF FIRE, KEEP CANDLES OR OPEN FLAMES AWAY FROM THIS PRODUCT AT ALL TIMES.

**CAUTION:** TO PREVENT ELECTRIC SHOCK. DO NOT USE THIS POLARIZED PLUG WITH AN EXTENSION CORD, RECEPTACLE OR OTHER OUTLET UNLESS THE BLADES CAN BE FULLY INSERTED TO PREVENT BLADE EXPOSURE.

**FCC Statement** This equipment has been tested and found to comply with the limits for a Class B digital device, pursuant to Part 15 of the FCC Rules. These limits are designed to provide reasonable protection against harmful interference in a residential installation. This equipment generates, uses and can radiate radio frequency energy and, if not installed and used in accordance with the instructions, may cause harmful interference to radio communications.

However, there is no guarantee that interference will not occur in a particular installation. If this equipment does cause harmful interference to radio or television reception, which can be determined by turning the equipment off and on, the user is encouraged to try to correct the interference by one or more of the following measures:

- Reorient or relocate the receiving antenna.
- Increase the separation between the equipment and receiver.
- Connect the equipment into an outlet on a circuit different from that to which the receiver is connected.
- Consult the dealer or an experienced radio/TV technician for help.

**CAUTION:** Changes or modifications not expressly approved by the party responsible for compliance with the FCC Rules could void the user's authority to operate this equipment.

THIS DEVICE COMPLIES WITH PART 15 OF THE FCC RULES. OPERATION IS SUBJECT TO THE FOLLOWING TWO CONDITIONS:

(1) THIS DEVICE MAY NOT CAUSE HARMFUL INTERFERENCE, AND (2) THIS DEVICE MUST ACCEPT ANY INTERFERENCE RECEIVED, INCLUDING INTERFERENCE THAT MAY CAUSE UNDESIRE OPERATION.

**Cables:**

Connections to this device must be made with shielded cables with metallic RF/EMI connector hoods to maintain compliance with FCC Rules and Regulations.

**Restrictions in the 5 GHz band:**

The device for operation in the band 5150-5250 MHz is only for indoor use to reduce the potential for harmful interference to co-channel mobile satellite systems.

**Important Note:**

In the spaces below, enter the model and serial number of your television (located at the rear of the television cabinet). Staple your sales receipt or invoice to the inside cover of this guide. Keep this user's guide in a convenient place for future reference. Keep the carton and original packaging for future use.

**Location of the required marking**

The rating sheet and the safety caution are on the rear of the unit.

**BATTERY PRECAUTIONS:**

- Batteries should not be exposed to excessive heat such as sunshine, fire or the like.
- The remote control unit uses infrared beams to transmit signals, so sunlight or fluorescent light on the remote sensor may shorten operating distance.
- Incorrect use of batteries may cause them to leak or burst. Read the battery warnings and use the
  - batteries
  - properly.
  - Do not mix old and new batteries.
  - Do not mix alkaline, standard (carbon-zinc), or rechargeable, (Ni-Cd, Ni-MH, etc.) batteries.
- Remove batteries if the remote control will not be operated for an extended period of time.

Serial number: \_\_\_\_\_

Model number: \_\_\_\_\_

## Important Safety Instructions

- 1) Read these instructions.
- 2) Keep these instructions.
- 3) Heed all warnings.
- 4) Follow all instructions.
- 5) Do not use this apparatus near water.
- 6) Clean only with dry cloth.
- 7) Do not block any ventilation openings. Install in accordance with the manufacturer's instructions.
- 8) Do not install near any heat sources such as radiators, heat registers, stoves, or other apparatus (including amplifiers) that produce heat.
- 9) Do not defeat the safety purpose of the polarized or grounding-type plug. A polarized plug has two blades with one wider than the other. A grounding type plug has two blades and a third grounding prong. The wide blade or the third prong are provided for your safety. If the provided plug does not fit into your outlet, consult an electrician for replacement of the obsolete outlet.
- 10) Protect the power cord from being walked on or pinched particularly at plugs, convenience receptacles, and the point where they exit from the apparatus.
- 11) Only use attachments/accessories specified by the manufacturer.
- 12) Use only with the cart, stand, tripod, bracket, or table specified by the manufacturer, or sold with the apparatus. When a cart is used, use caution when moving the cart/apparatus combination to avoid injury from tip-over.



- 13) Unplug this apparatus during lightning storms or when unused for long periods of time.
- 14) Refer all servicing to qualified service personnel. Servicing is required when the apparatus has been damaged in any way, such as power-supply cord or plug is damaged, liquid has been spilled or objects have fallen into the apparatus, the apparatus has been exposed to rain or moisture, does not operate normally, or has been dropped.
- 15) The wall plug is the disconnecting device. The plug must remain readily operable.
- 16) Remote control batteries should not be exposed to excessive heat such as sunshine, fire, or the like. Dispose of used battery promptly and correctly, according to local environmental laws and guidelines in force.

**CAUTION:** Risk of fire or explosion if the battery is replaced by an incorrect type.

- 17) The apparatus should not be exposed to dripping or splashing, and no objects filled with liquids, such as vases, should be placed on the apparatus.
- 18) No naked flame sources, such as lighted candles, should be placed on the apparatus.
- 19) Your TV has four VESA mounting holes on the back. If you attach a wall-mount bracket or TV stand to the back of your TV, the bracket or stand must be securely attached using all four holes. If you do not use all four mounting holes, your TV may fall and cause property damage or personal injury. See the documentation that came with your wall mount or TV stand for complete mounting instructions.

### **WARNING:**

The excessive sound pressure from earphones and headphones can cause hearing loss.

### **CAUTION:**

Double pole, neutral fusing.  
Disconnect mains before servicing.



This symbol indicates that this product incorporates double insulation between hazardous mains voltage and user accessible parts. When servicing use only identical replacement parts.

## Important Safety Instructions

### WARNING

#### 1) Stability Hazard

The television set may fall, causing serious personal injury or death.

Never place a television set in an unstable location. A television set may fall, causing serious personal injury or death. Many injuries, particularly to children, can be avoided by taking simple precautions such as:

- Using cabinets or stands recommended by the manufacturer of the television set.
- Only using furniture that can safely support the television set.
- Ensuring the television set is not overhanging the edge of the supporting furniture.
- Not placing the television set on tall furniture (for example, cupboards or bookcases) without anchoring both the furniture and the television set to a suitable support.
- Not placing the television set on cloth or other materials that may be located between the television set and supporting furniture
- Educating children about the dangers of climbing on furniture to reach the television set or its controls.

If your existing television set is being retained and relocated, the same considerations as above should be applied.

- 2) To reduce the risk of fire or electric shock, do not remove any cover or expose the device to rain or moisture. No user-serviceable parts are inside. Refer servicing to qualified service technicians.
- 3) After completing any service or repair to this device, ask the service technician to perform routine safety checks to determine that your TV is in correct operating condition.
- 4) These servicing instructions are for use by qualified service personnel only. To reduce the risk of electric shock, do not perform any servicing other than that contained in the operating instructions unless you are qualified to do so.
- 5) When replacement parts are required, make sure that the service technician uses replacement parts specified by the manufacturer that have the same characteristics as the original part. Unauthorized substitutions may result in, electric shock, personal injury, or other hazards.
- 6) If an outside antenna or cable system is connected to your TV, make sure that the antenna or cable system is grounded to provide some protection against voltage surges and built-up static charges. Article 810 of the National Electrical Code, ANSI/NFPA No. 70, provides information with respect to correct grounding of the mast and supporting structure, grounding of the lead-in wire to an antenna discharge unit, size of grounding conductors, location of the antenna-discharge unit, connection to grounding electrodes, and requirements for the grounding electrode.

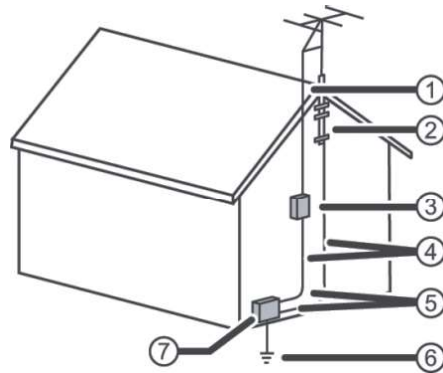

- ① Antenna lead-in wire
- ② Grounding clamp
- ③ Antenna discharge unit
- ④ Grounding conductors
- ⑤ Ground clamps Power service
- ⑥ grounding electrode system
- ⑦ Electric service equipment

#### Note to CATV system installer

Article 820 of the National Electrical Code, ANSI/NFPA No. 40 provides guidance for correct grounding. Specifically, it states that the cable ground must be connected to the grounding system of the building as close to the point of cable entry as practical.

- 7) For added protection for your device receiver during a lightning storm, or when it is left unattended and unused for long periods of time, unplug it from the power outlet and disconnect any antenna or cable system. This helps prevent property damage and personal injury from lightning and power line surges.
- 8) An outside antenna system should not be located in the vicinity of overhead power lines or other electric light or power circuits, or where it can fall into such power lines or circuits. When installing an outside antenna system, take extreme care to keep from touching such power lines or circuits as contact with them might be fatal.
- 9) Your TV's screen is made of glass. Do not drop your TV or hit, jolt, or press hard against the LCD panel. If the screen breaks, be careful of broken glass.  
If the LCD panel is broken, make absolutely sure that you do not touch the liquid in the panel. This may cause skin inflammation.  
If the liquid gets in your mouth, immediately gargle, rinse, and consult with your doctor. Also, if the liquid gets in your eyes or touches your skin, consult with your doctor after rinsing for at least 15 minutes or longer in clean water.

## Important Safety Instructions

- 10) Unplug this TV from the power outlet and refer servicing to qualified service personnel under the following conditions:**

  - When the power supply cord or plug is damaged or frayed.
  - If liquid has been spilled or objects have fallen into your TV.
  - If your TV has been exposed to rain or water.
  - If your TV does not operate normally by following the operating instructions. Adjust only those controls covered by the operating instructions because incorrect adjustment of other controls may result in damage and will often require extensive work by a qualified technician to restore your TV to its normal operation.
  - If your TV has been dropped or damaged in any way.
  - When your TV exhibits a distinct change in performance.
  
- 11) Operate your TV only from the type of power source indicated on the marking label. If you are not sure of the type of power supplied to your home, consult an electrician or your local power company.**
  
- 12) Moisture will form on the TV if the TV is brought from cool surroundings into a warm room or if the temperature of the room rises suddenly. When this happens, the TV's performance may be impaired. To prevent this, let the TV stand in its new surroundings for about an hour before switching it on, or make sure that the room temperature rises gradually. Condensation may also form during the summer if the TV is exposed to the breeze from an air conditioner. In such cases, change the location of the TV.**
  
- 13) Your TV may contain materials that are regulated for environmental reasons. Your TV also contains materials that can be recycled and reused. To help protect the environment, contact your local authorities for information about disposal or recycling and about finding a recycler in your area before you dispose of your TV.**
  
- 14) To avoid interference with your TV picture and sound, operating problems, or even damage, keep your cordless and cellular telephones away from the TV.**
  
- 15) The LCD panel contains almost 3 million thin film transistors, which provide exceptionally sharp video quality. Occasionally, a few non-active pixels may appear on the screen as a fixed blue, green, or red point. These non-active pixels do not adversely affect the performance of your TV, and are not considered defects.**

## Important Safety Instructions

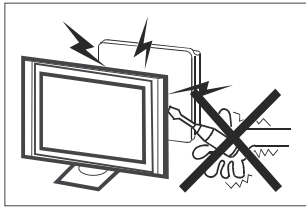

High voltages are used in the operation of this television receiver. Do not remove the cabinet back from your set. Refer servicing to qualified service personnel.

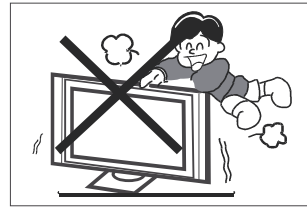

Never stand on, lean on, or suddenly push the television or its stand. You should pay special attention to children. Serious injury may result if it falls.

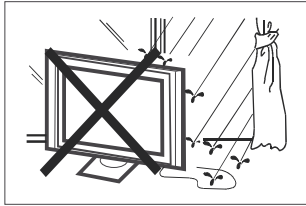

To prevent fire or electrical shock hazard, do not expose the television receiver to rain or moisture.

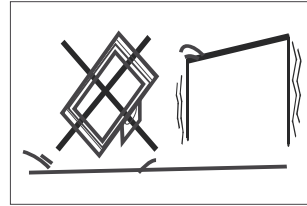

Do not place your television on an unstable cart, stand, shelf or table. Serious injury to an individual, and damage to the television, may result if it falls. Recommended to utilize rear mount screw holes for anti-tipping (hardware not included).



Do not drop or push objects into the television cabinet slots or openings. Never spill any kind of liquid on the television receiver.

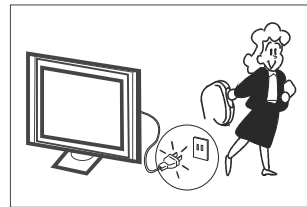

When the television receiver is not used for an extended period of time, it is advisable to disconnect the AC power cord from the AC outlet.

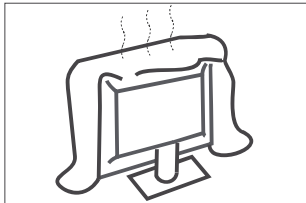

Do not block the ventilation holes in the back cover. Adequate ventilation is essential to prevent failure of electrical components.

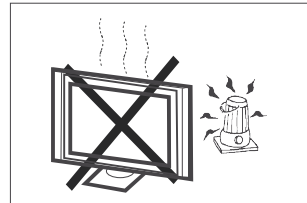

Avoid exposing the television receiver to direct sunlight and other sources of heat. Do not stand the television receiver directly on other products which give off heat, e.g. video cassette players and audio amplifiers. Do not place naked flame sources, such as lighted candles on the television.

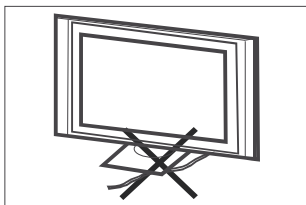

Do not trap the power supply cord under the television receiver.

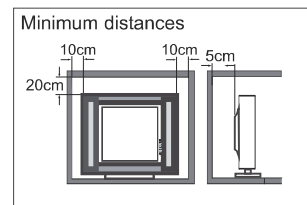

If the television is to be built into a compartment or similar enclosure, the minimum distances must be maintained. Heat build-up can reduce the service life of your television, and can also be dangerous.

# INTRODUCTION

## Antenna

### Main features

- Wide screen for a complete home theater experience.
- Super slim LCD TV with LED backlight.
- Integrated DVB-T2 TV tuner for HDTV broadcast reception.
- HDMI inputs for true digital connections.

### Accessories

Infrared Remote Control.....	1
User's Manual.....	1
Battery(AAA) .....	2
Screws.....	4
Base stand.....	2
Spacers.....	2 (Only for 4T-C50EK2X model)

### Specifications

Viewing PictureSize(diagonal)	50"class 50"diagonal	55"class 55"diagonal	60"class 60"diagonal	65"class 65"diagonal	70"class 70"diagonal	75"class 75"diagonal
Resolution:	3840 x 2160					
Aspect Ratio:	16:9					
TV System:	DVB-T/T2/C					
Video Signal System:	NTSC, PAL, SECAM					
Power Consumption:	135W	150W	165W	170W	220W	260W
Input Power Voltage:	100-240V~, 50/60Hz					
Audio OutputPower(THD≤ 10%):	2x10W					
High-Definition Multimedia Interface (HDMI) Input	x 4					
Composite Input (mini)	x 1					
Headphone Output	x 1					
Optical Output	x 1					
LAN	x 1					
USB 2.0 Input	x 2					



The terms HDMI, HDMI High-Definition Multimedia Interface, and the HDMI Logo are trademarks or registered trademarks of HDMI Licensing Administrator, Inc.



Dolby, Dolby Vision, Dolby Atmos, and the double-D symbol are registered trademarks of Dolby Laboratories Licensing Corporation. Manufactured under license from Dolby Laboratories. Confidential unpublished works. Copyright © 2012–2022 Dolby Laboratories. All rights reserved.

# INSTALLATION

## Front panel

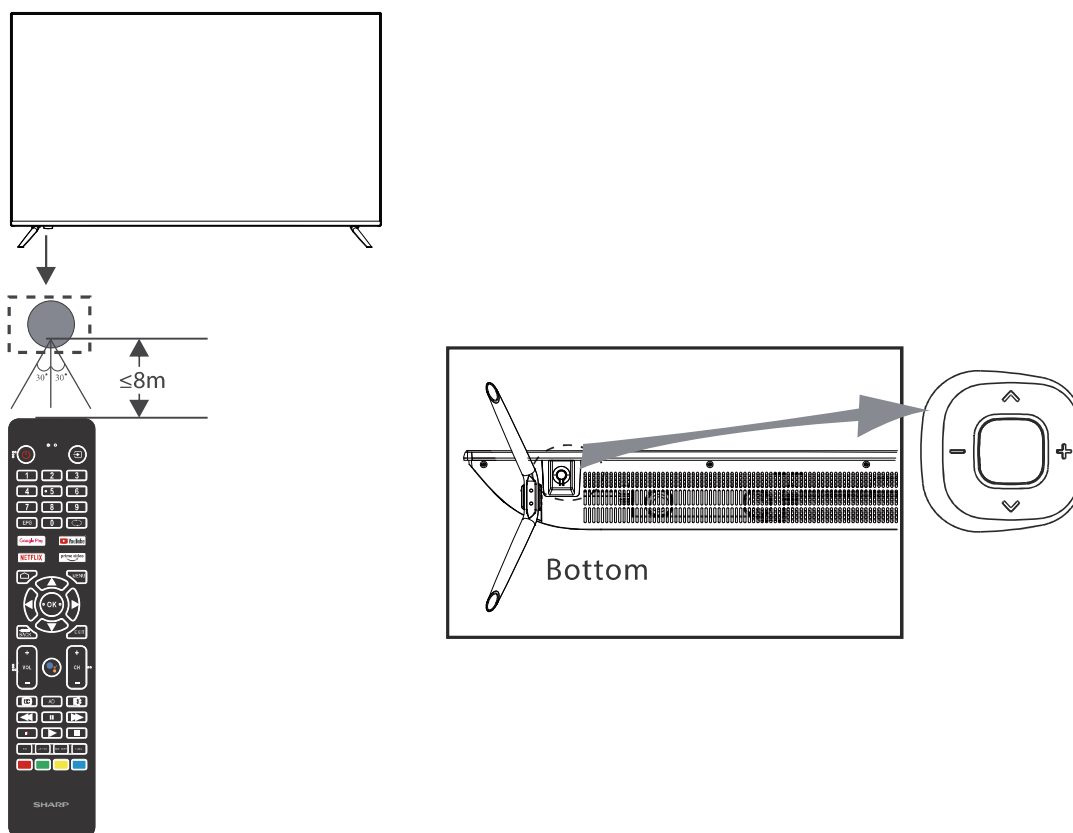

## KEYBOARD

1. When the TV is turned on, press the local key for more than 3S to enter standby.
2. For the third-party application, main scene and USB, only the operations in 1) above are detected, and the following 3 operations are not executed;
3. Press the local key for less than 3S to enter the local key menu.  
The local key menu includes six options: on / off, program +, program -, volume +, volume -, and program source;  
a) When the local key menu is displayed, the key time is less than 1.5s, and the focus moves backward once in sequence;  
b) When the local key menu is displayed, the long key pressing time is greater than 1.5s, and the function of entering the current focus option is executed.

## REAR Connections



All the terminals are (from left to right): ETHERNET, OPTICAL, USB, HDMI4, HDMI3, HDMI2, Mini AV INPUT, RF.

## SIDE Connections



All the terminals are (from left to right):  
USB2.0, HDMI1(eARC/ARC), HEADPHONE.



# INSTALLATION

## Antenna

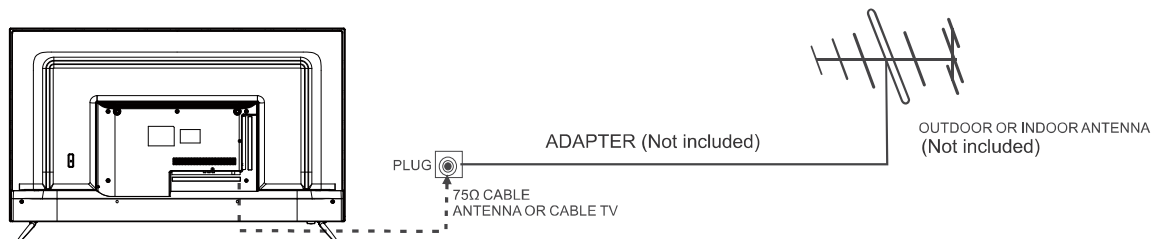

Note:  
Aerial connections: IEC connector.  
Input impedance: 75 Ω unbalanced.

Antenna input impedance of this unit is 75ohm. VHF/UHF 75ohm coaxial cable can be connected to the antenna jack directly.

### Antennas with 75 Ω Round Leads

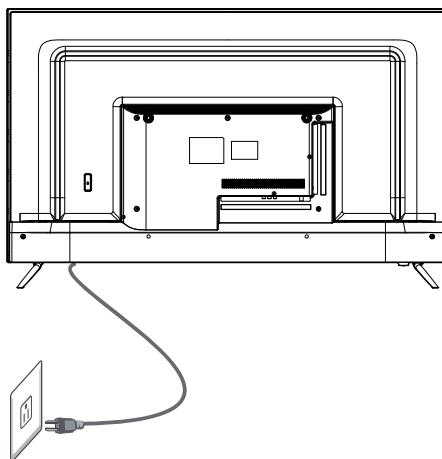
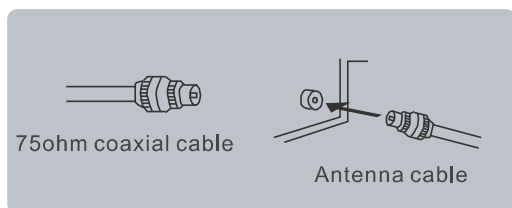

### Power connection

Please note: After unpacking, allow the TV to reach ambient room temperature before connection the TV to the mains power socket.  
Connect the power cord plug to the mains power socket.

### CABLE

When shipped from the factory, the Signal Type option is for the RF connector (F-type) set to the "AIR" (Over-the air antenna) mode.

# INSTALLATION

## Base Stand Assembly Instruction

### The base stand

Prepare to place the TV with the display side down on a flat surface. Due to the size and weight of this TV, the use of 2 people is recommended when moving it. Ensure the table or desk you use provides a flat, totally clean surface, and use a soft cloth between the face of the TV and the table to protect the TV's screen.

1. Locate the 2PCS of the base stand and insert it into the gap in the bottom of the TV , and check that it is securely held in place as below.

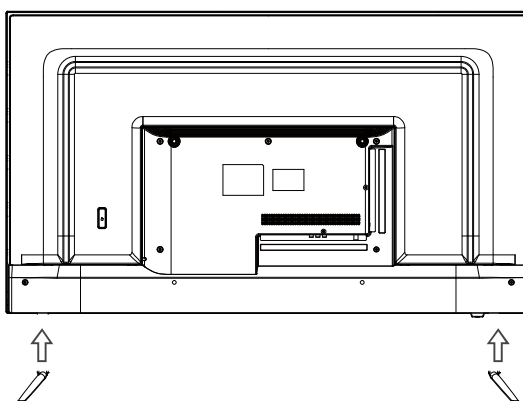

2. Lock 4/6 screws in the designated location as below and check each screw is firmly tightened.

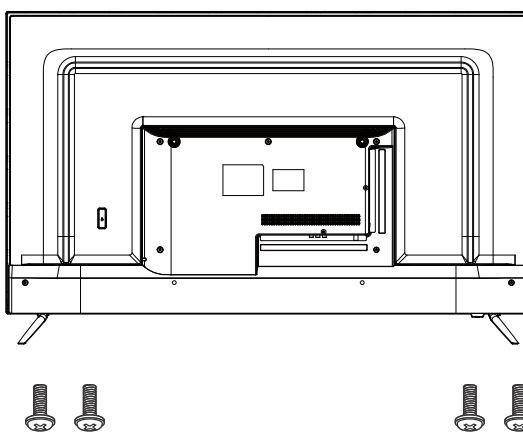

50"/55"(M4x28mm)x4  
60"/65"/70"(M4x14mm)x6  
75"(M6x40mm)x4

# INSTALLATION

## AV Equipment

You can use the rear input terminals as follows.

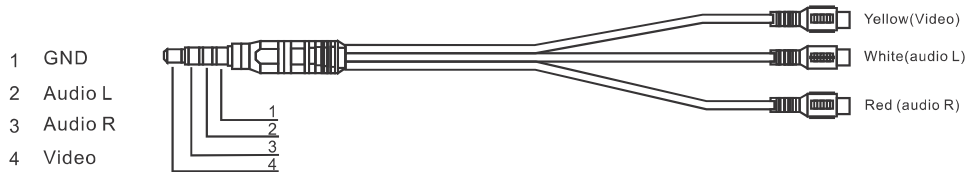
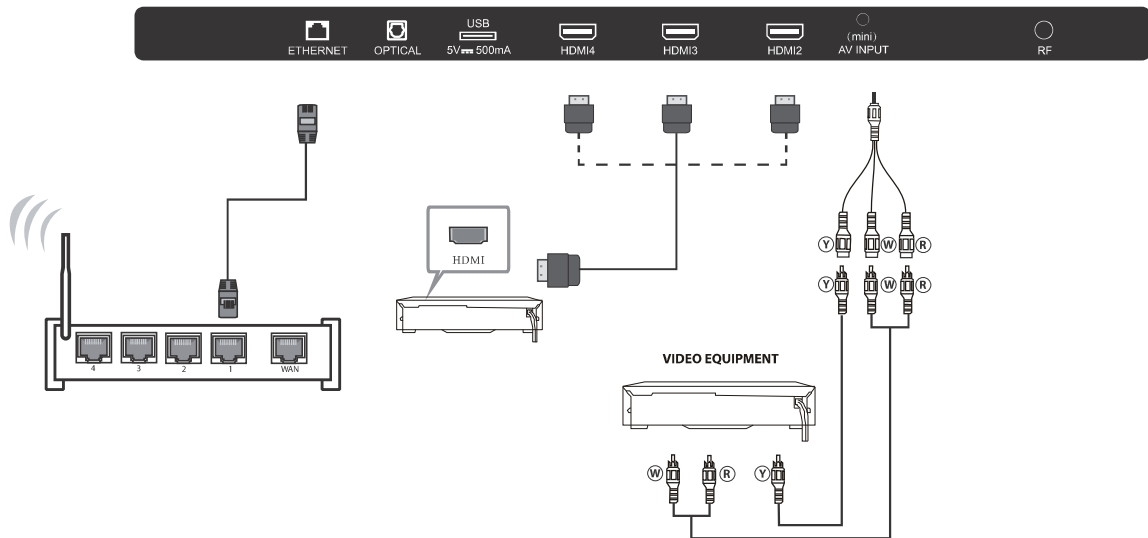

Note: It does not support headset with microphone, please plug in headphones only.

Video Equipments: VCR, Multi Disc Player, DVD Player, Camcorder, Video Game, etc.

# Wall Mount

## Instruction for Wall Mount

1. Place the LED LCD Television onto a solid surface. Please place some soft material over the front of the screen to protect it from any damage.

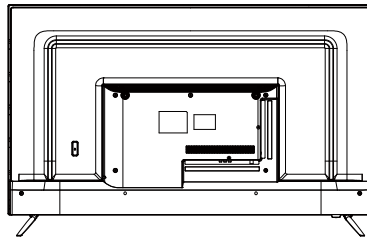

2. Use the four screws provided to fix the TV onto a wall mounting bracket (not included) via the four VESA standard holes on the back of the television.

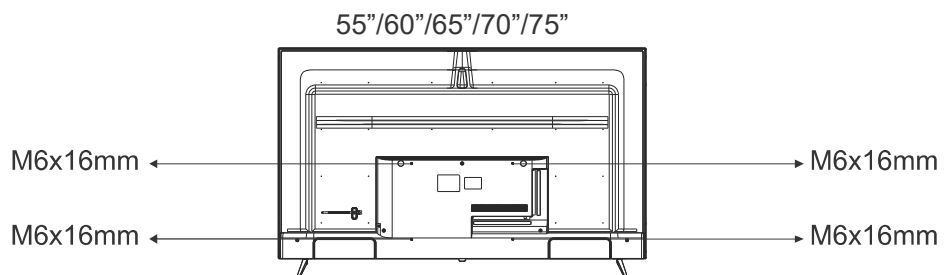
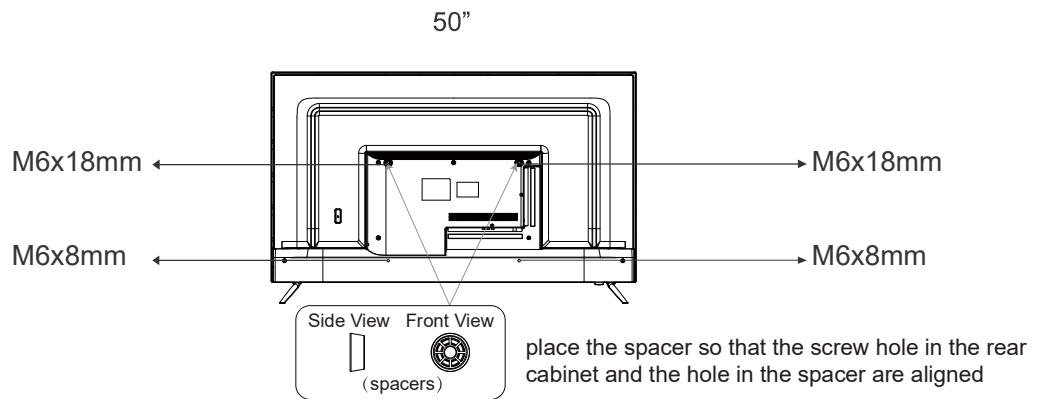

# General Description

## Installing Batteries in the Remote Control

### Installing Batteries

- 1** Open the battery compartment cover on the back side.



- 2** Insert two 1.5V AAA size batteries in correct polarity. Don't mix old or used batteries with new ones.



- 3** Closed the cover.

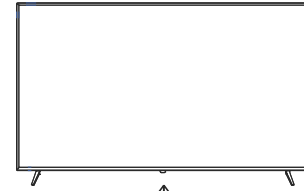

- ✦ Point the remote towards the remote control sensor of the TV and use it within 8 meters.
- ✦ Put the used batteries into the recycling bin since they can negatively affect the environment.

#### Note:

- One loading of batteries will last for 1 year under normal use.
- If you do not intend to use the remote controller for a long period of time, remove them to avoid damage due to leakage.
- Do not use old and new batteries together.
- The batteries (battery pack or batteries installed) shall not be exposed to excessive heat such as sunshine, fire or the like.

## General Description

## Overview of remote control



### Loading batteries:

- 1) Remove the lid of the battery compartment.
- 2) Insert 2 size AAA batteries with polarities as indicated inside the compartment.
- 3) Replace the lid.

### Note:

- 1) A loading of batteries should be last one year under normal use.
- 2) If you don't intend to use the remote control for a long period of time, remove batteries to avoid damage due to leakage.
- 3) Do not mix old and new batteries or different types.
- 4) Do not throw batteries into fire or water.
- 5) The batteries (battery pack or batteries installed) should not be exposed to excessive heat such as sunshine, fire or the like.

# General Description

## Overview of remote control

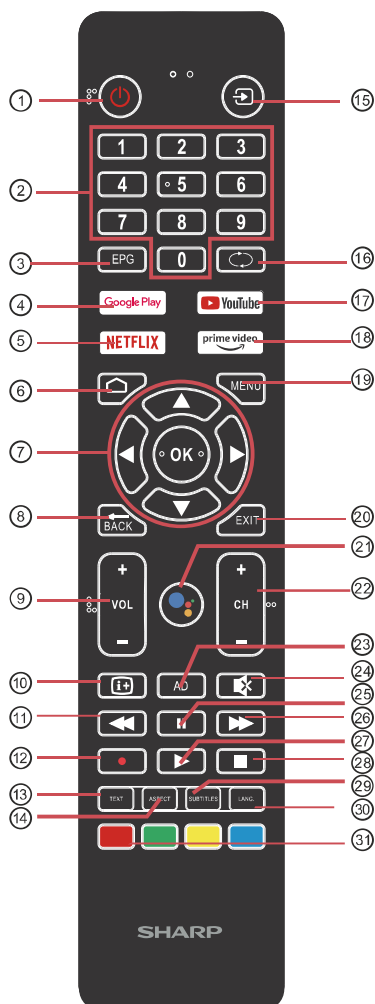

1. **POWER:** To set the TV to Standby or Power On modes.
2. **NUMERIC KEY:** For direct access to channels.
3. **EPG Button:** Press to display the electronic program guide in the mode.
4. **GOOGLE PLAY Button:** Press to access Google Play Movies & TV (internet connection required).
5. **NETFLIX Button:** Connects to Netflix for viewing online TV shows and films (internet connection required).
6. **Home** : Press to open the Home page.
7. **OK:** Confirms selection.  
▲▼◀▶ : Presss to navigate the on-screen menu.
8. **Back:** Return to the previous menu.
9. **Vol +/-:** To adjust sound level.
10. **i+** : Press to display the channel information.
11. **◀◀ (Reverse):** Reverse playback rapidly.
12. **● (PVR):** Record video.
13. **TEXT:** Press to select the teletext mode.
14. **ASPECT:** Press to change the picture aspect ratio.
15. **↵** : Select among the different input signal sources.
16. **↶** : Jumps to last channel viewed.
17. **YOUTUBE Button:** Press to access YouTube (internet connection required).
18. **PRIME VIDEO Button:** Connects to Prime Video for Viewing online TV shows and films (internet connetion required).
19. **MENU:** Press to open or close the on-screen menu.
20. **EXIT Button:** Press to exit menus or Apps.
21. **Google Assistant:** Press to open the Google Assistant or start a voice search.
22. **CH+/CH-:** To access the next or previous channels.
23. **AD Button:** Open or close audio description.
24. **MUTE Button:** Press to mute or un-mute the volume.
25. **|| (Pause):** Pause playback.
26. **▶▶ (Forward):** Advance playback rapidly.
27. **▶ (Play):** Start playback.
28. **■ (Stop):** Press to stop multimedia playback.
29. **SUBTITLES:** To turn on subtitles in DTV mode.
30. **LANG. :** Select an alternative language if available.
31. **Coloured buttons:** Implement the relevent operations cording to the prompt at the botton of the menu in the text.

## External Connection

### Connecting a Camcorder

The rear panel jacks on your TV make it easy to connect a camcorder to your TV. They allow you to view the camcorder tapes without using a VCR.

Each Camcorder has a different back panel configuration.

When connecting a Camcorder or DVD, match the color of the connection terminal to the cable.

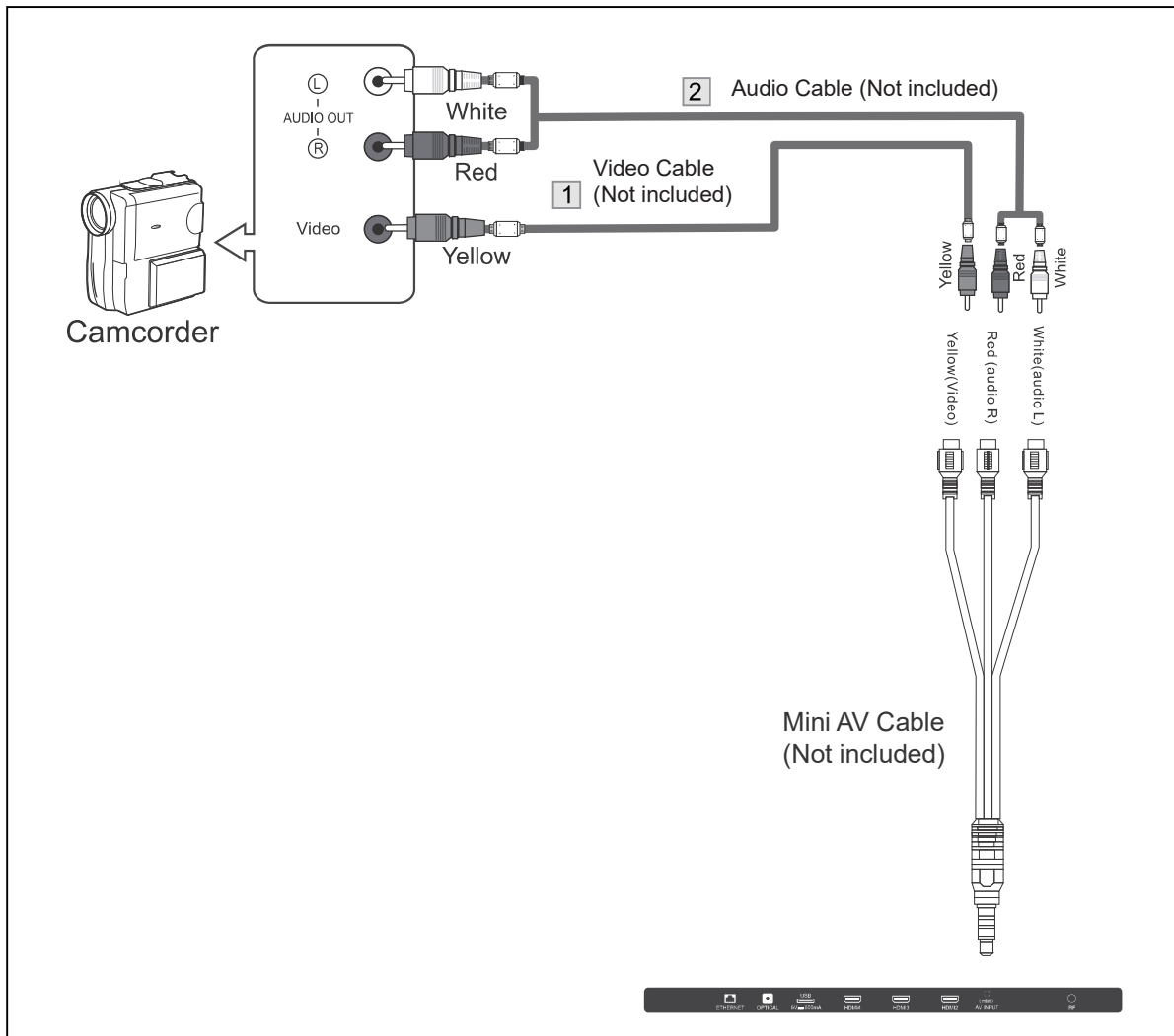

1) Connect a Mini AV Cable to the mini jack terminal on this TV.

Next

2) Connect AV VIDEO cable and Audio cables from the camcorder to each of the "AV INPUT" and "AUDIO L and R" of this Mini AV Cable.

#### Notes:

1. Whenever you connect an external device to your TV, make sure that power on the unit is turned off.
2. When connecting an external device, match the color of the connection terminal to the cable.



## External Connection

### Connecting DVD Player / Set-Top Box

This connection can only be made if there is a HDMI Output connector on the external device.

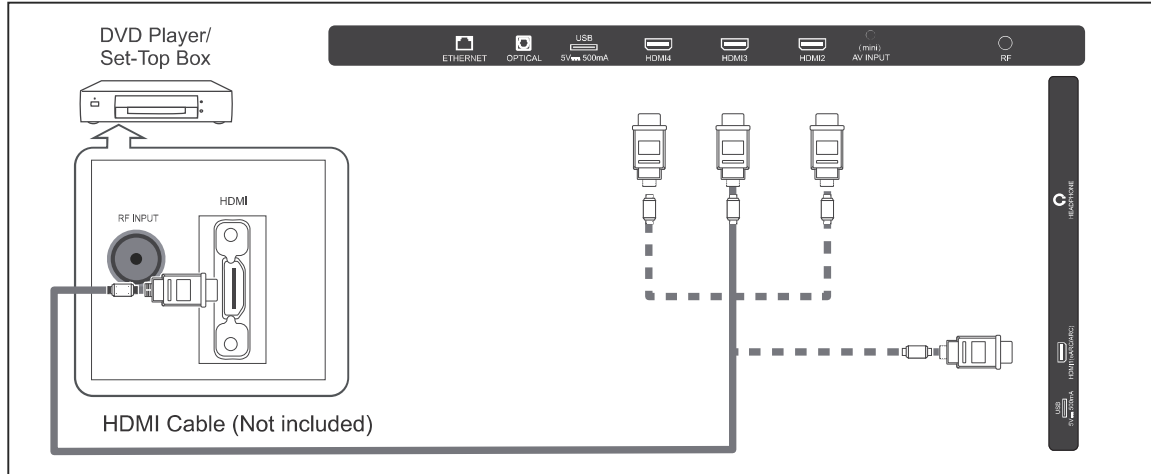

What is HDMI?

HDMI, or high-definition multimedia interface, is a next-generation interface that enables the transmission of digital audio and video signals using a single cable without compression. Multimedia interface is a more accurate name for it especially because it allows multiple channels of digital audio (5.1 channels).

The difference between HDMI and DVI is that the HDMI device is smaller in size, has the HDCP (High Bandwidth Digital Copy Protection) coding feature installed, and supports multi-channel digital audio.

Each DVD player/STB has a different back panel configuration.

Connect an HDMI Cable between the HDMI1, HDMI2, HDMI3, HDMI4 connector on the TV and the HDMI connector on the DVD player/Set-Top Box.

While using ARC, connect the ARC compatible external device to HDMI 1, under Live TV, press the "MENU" button to select "Speaker", "External Audio System"

#### Notes:

1. Whenever you connect an external device to your TV, make sure that power on the unit is turned off.
2. When connecting an external device, match the color of the connection terminal to the cable.

# External Connection

## Connecting Digital Audio System

The rear panel jacks on your TV make it easy to connect a Digital Audio System to your TV.

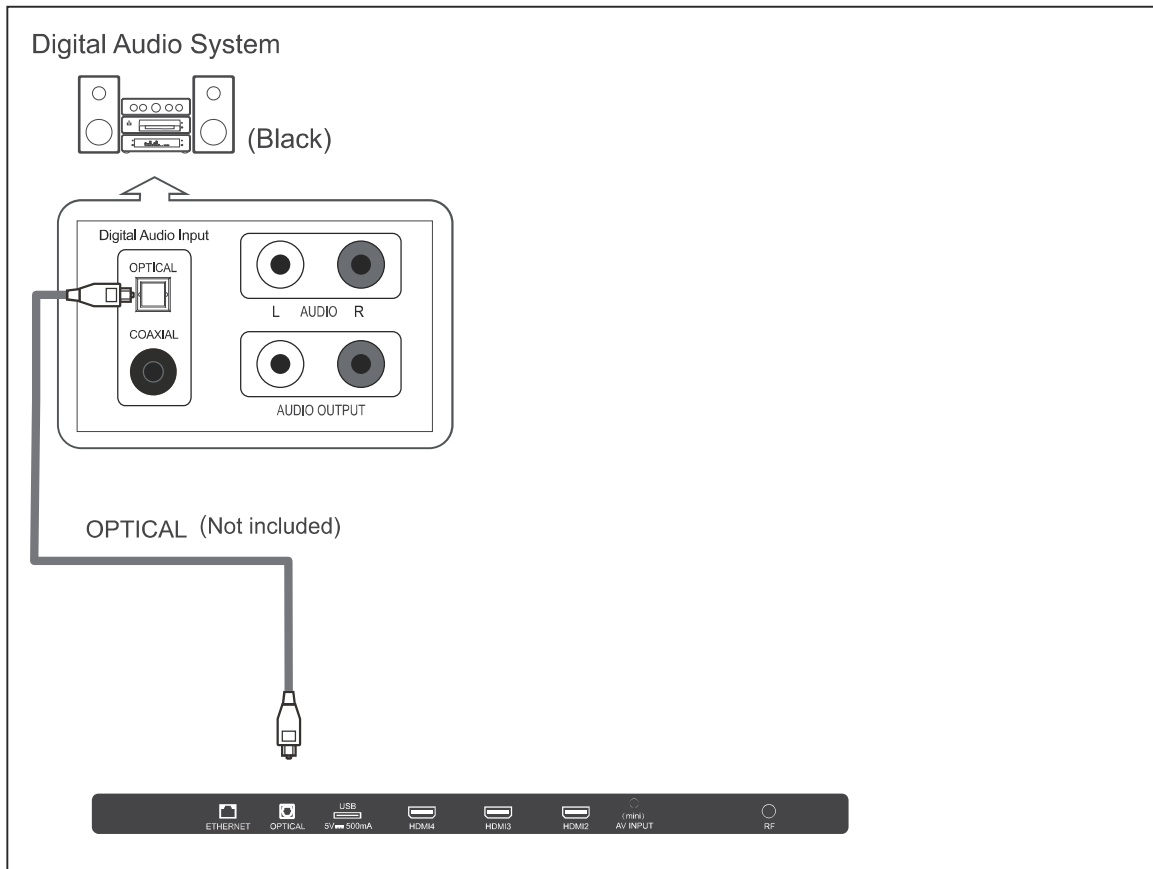

5.1 CH audio is possible when the TV is connected to an external device supporting 5.1 CH.

Connect an OPTICAL Cable between the OPTICAL jacks on the TV and the Digital Audio Input jacks on the Digital Audio System. When a Digital Audio System is connected to the OPTICAL terminal: Decrease the gain (volume) of the TV, and adjust the volume level with the Digital Audio System's volume control.

## Supporting Signals

Input	System	Resolution
AV	NTSC	480i
	PAL	576i

Input	Mode
RF	DVB-T/T2/C
	PAL/NTSC(Analog)

Input	Resolution	Vertical Frequency
HDMI	720p	50Hz/60Hz
	1080i	50Hz/60Hz
	1080p	50Hz/60Hz
	3840x2160	24Hz/25Hz/30Hz/60Hz

# Menu Operations

## INITIAL SETUP

The first you turn your TV, the setup wizard will guide you through setting up basic settings. Please according to the Text Tip to First Time Setup.

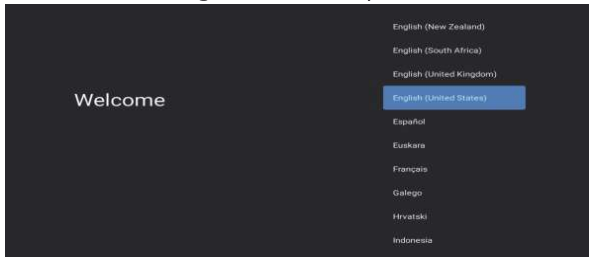

Press ▲/▼ to select the system language and press OK to confirm the language. If you are using an infrared remote control, please ignore the Text Tip and press the back button to exit this page.



This function is used for the remote control pair code. To enable Google Assistant mic on your remote control, press and hold LEFT button and MENU button simultaneously for 5 seconds. When "BT\_VoiceRC\_20\_1" appears in the upper right corner of the screen, select the name and press the "OK" button. After the code is successful, you can use the Bluetooth remote control to operate the TV.

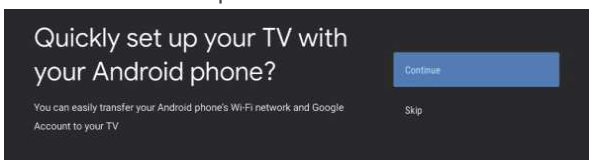

Connect your Android phone to your TV, select "Continue" to continue the connection, and choose "Skip" to skip this step.

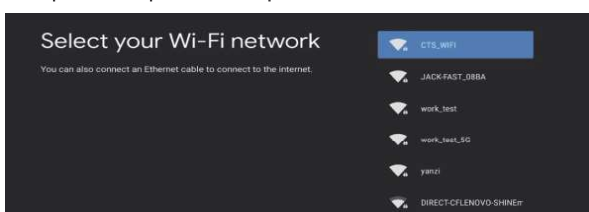

Press ▲/▼ to select the Wifi to connect, press OK and enter the password to confirm the connection is successful. Recommended settings for Wi-Fi routers: For the best quality, performance, and reliability, we recommend choose 5Ghz band settings for Wi-Fi routers.

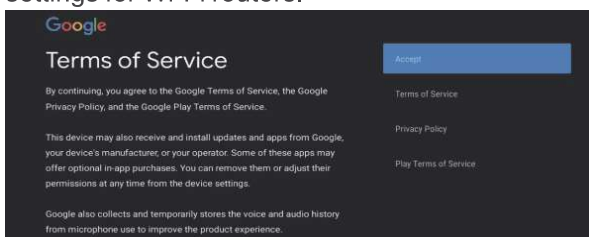

By accepting the Google Terms of Service to improve the product experience, select "Accept" to accept this condition.

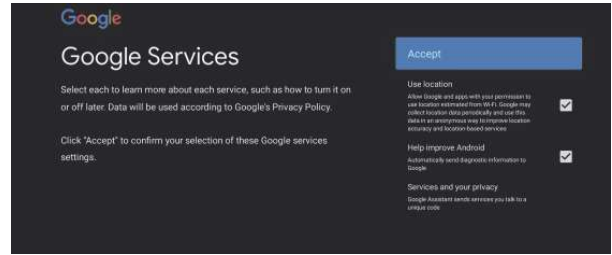

Click "Accept" to confirm your selection of these Google services settings.

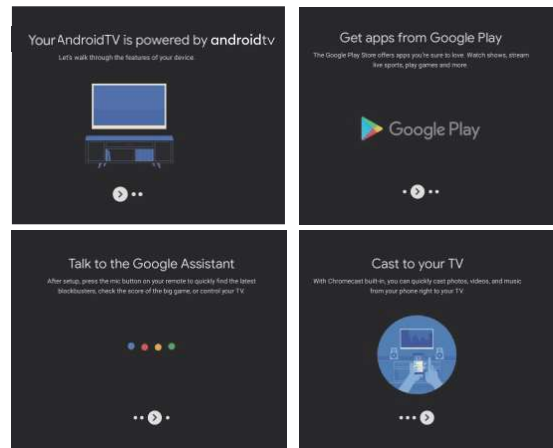

1. Your device is powered by Android TV and press the ► key to select the browsing feature.
2. You can get more apps from Google Play and press the ► key to go to the next screen.
3. Transfer photos and other content to the TV via the built-in chromecast, press OK to complete the browsing.

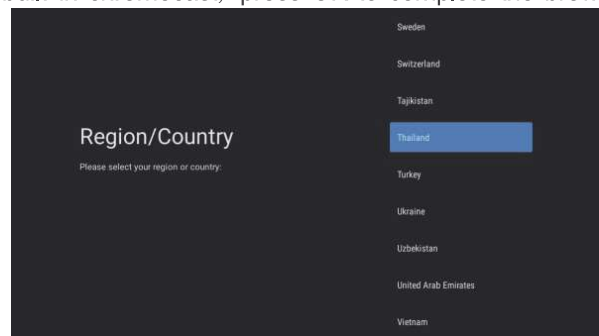

Press ▲/▼ to select your region or country.

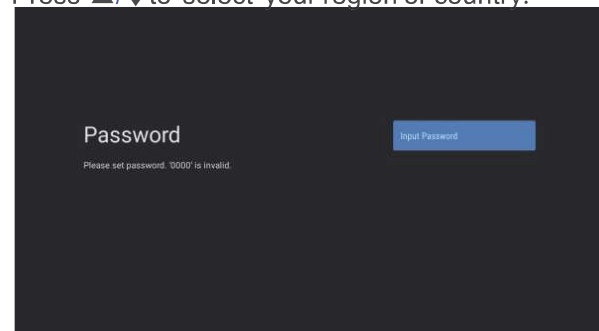

Used to set your device's password to ensure security and privacy.

# Menu Operations

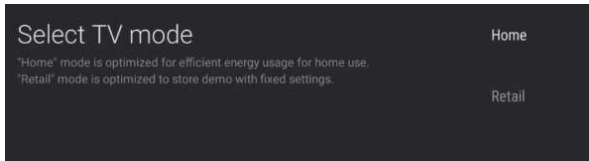

For selecting the mode, press ▲/▼key to select Home mode and press OK to confirm.

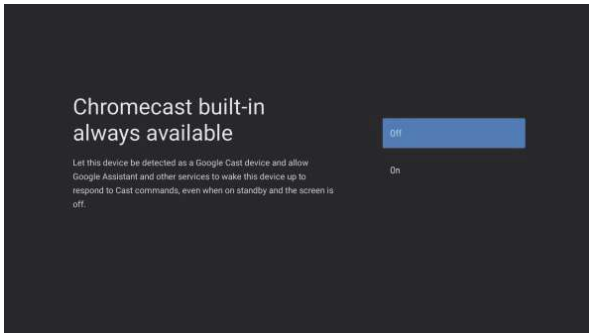

Press ▲/▼ to turn on or off the always available features of chrome cast.

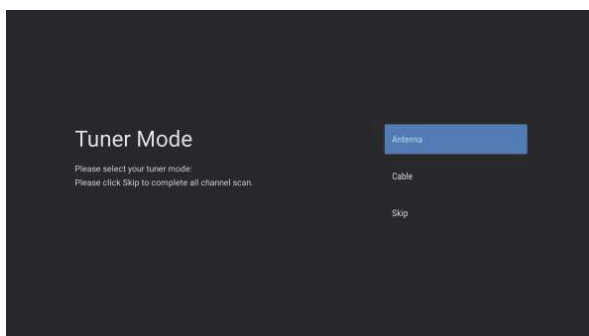

To select the Tuner mode for searching, press ▲/▼ to select and press OK to confirm.

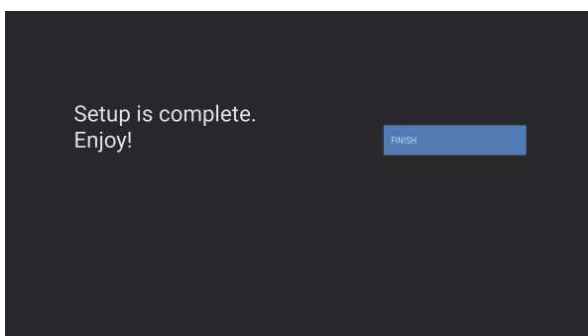

Press **OK** to complete the setup.

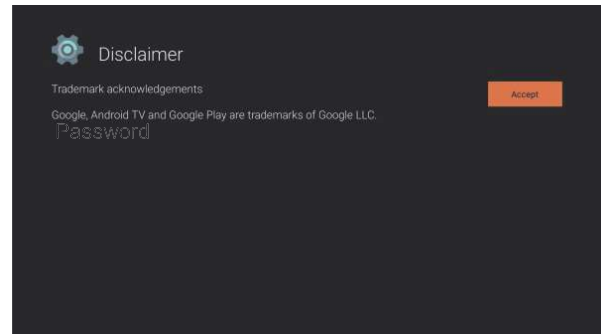

Press the OK to agree to Disclaime (Disclaimer). After setting is complete, You can watch TV.

## HOME SCREEN

Press the HOME button to go to the HOME page.



- ① Open the google assistant or start a voice search.
- ② Among the applications installed on the TV, the icons for the favourite applications are shown inside here. (Favourite applications can be added/deleted/changed its order by users.)
  - 📱 **Apps:** Click to jump to Apps screen where all the installed applications are listed.
- ③
  - 🔔 **Notification:** Display the notifications.
  - 📺 **Inputs:** Icon to select an input source.
  - 📶 **Network & Internet:** Icon to Setup Network, Such as wifi.
  - ⚙️ **Settings:** Various settings can be configured here. For details on the settings, see the next explanation.

# Menu Operations

## INPUT SOURCE

1. In the HOME interface, press ▲/▼/◀/▶ to select the “Inputs” icon, press OK to open the input source list, then press up to highlight an input and press OK to switch.



2. Under live TV, press the INPUT button to display the list of input sources. You can select the desired source.

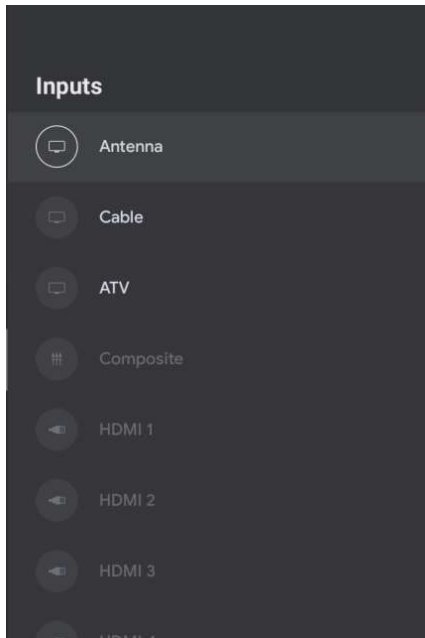

## NAVIGATING THE ON-SCREEN MENU

1. There are two ways to enter. First, in live, press the menu button to display TV options, press ▲/▼/◀/▶ to select the settings menu and press OK to confirm. Second, in the HOME interface, press the ► key to select the icon of the circular settings menu, press OK to confirm.

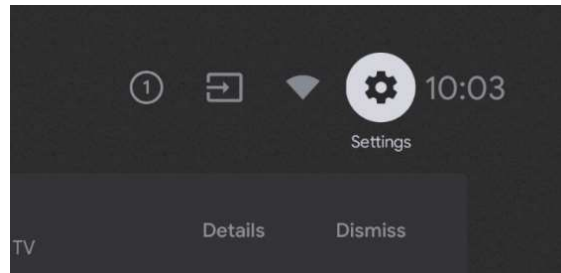
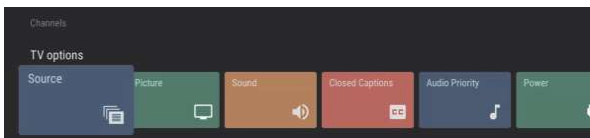

2. Press ▲/▼ button to select what you want set.  
3. Press OK to enter setting.

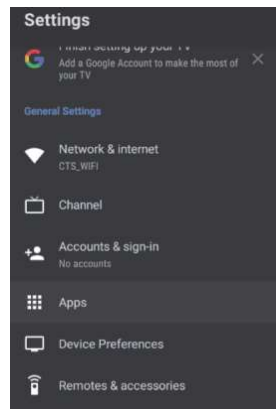

Press BACK to return to the previous menu. If the main menu is displayed, pressing BACK will close the onscreen menu.

## Network & internet

1. Press ▲/▼ button to select what you want set.  
2. Press OK button to adjust.  
3. After finishing your adjustment, press OK button to save and return to the previous menu.

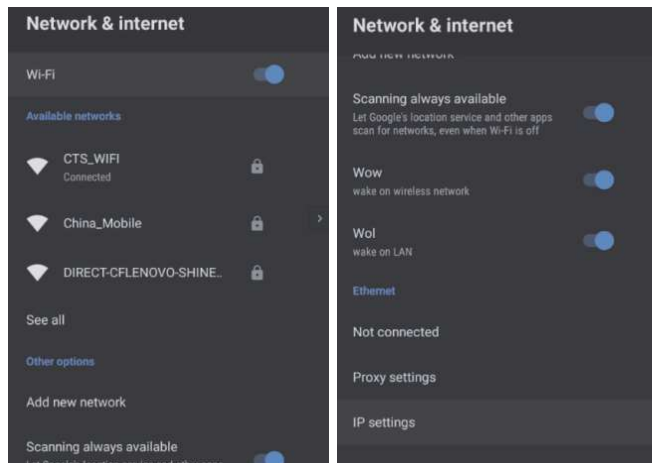

# Menu Operations

## CHANNEL

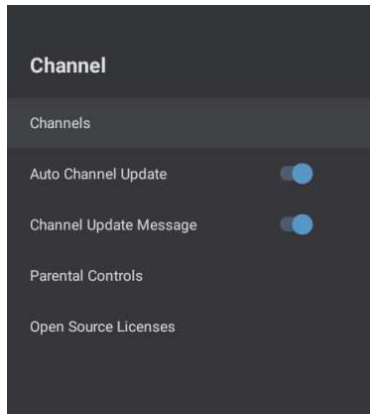

**Channels:**  
Display the scan sub-menu based on different channel installation models.

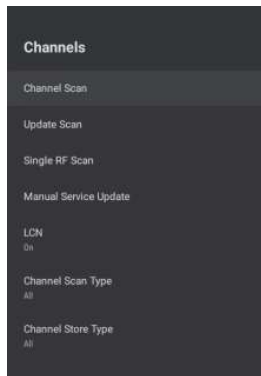

**Antenna:**  
Select the Antenna channel on the INPUT interface, the TV can receive analog and digital (DVB-T/DVB-T2) broadcasting signals.

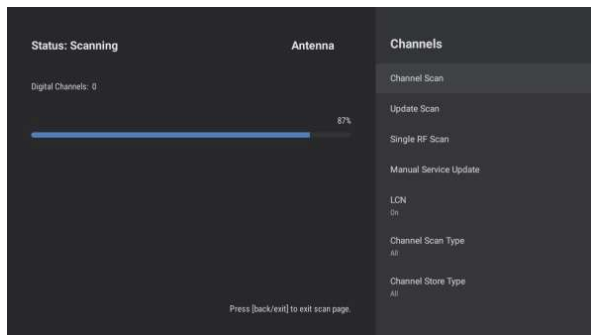

**Cable:**  
Select the Cable channel on the INPUT interface, the TV can receive analog and QAM broadcasting signals.

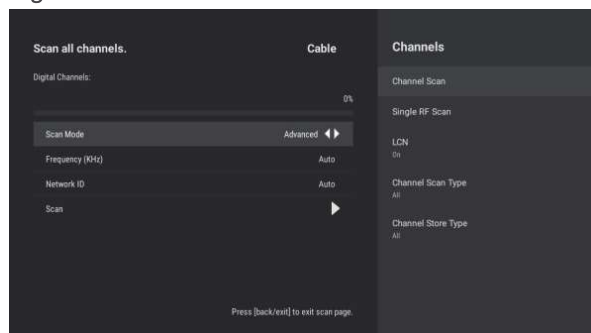

## ACCOUNTS&SIGN IN

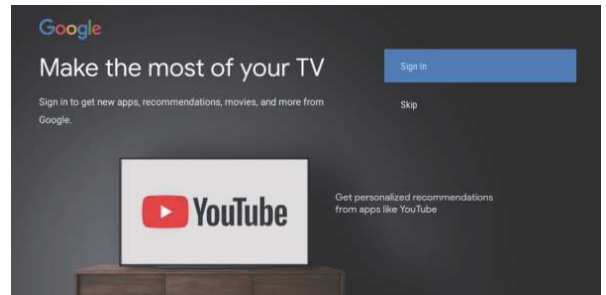

Press ▲/▼ button to select Sign in or Skip.

## APPS

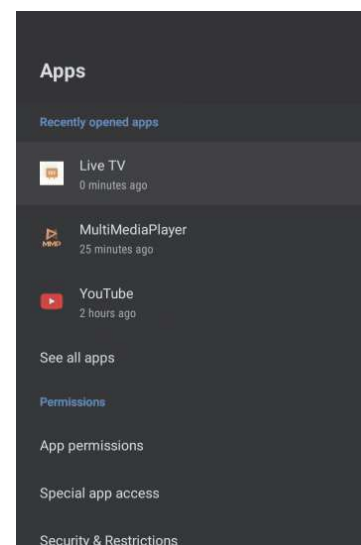

In this menu, you can set the APP permissions, and read the app lists.

1. Press ▲/▼ button to select what you want set.
2. Press OK button to adjust.
3. After finishing your adjustment, Press BACK button to return to the previous menu.

# Menu Operations

## DATE&TIME

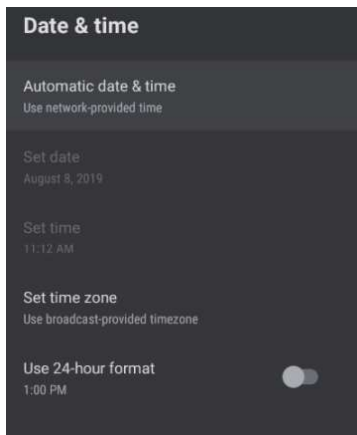

**Automatic date&time**-Press ▲/▼ button to select the option then press OK button to enter the sub-menu.  
(Optional:Use network-provided time,Off)

### NOTE:

•Manually adjusting date&time settings will automatically change the **Automatic date& time to OFF.**

**Set date:**Press ▲/▼button to select the option then press OK button to enter the sub-menu.

**Set time:**Press ▲/▼button to select the option then press OK button to enter the sub-menu.

**Set time zone:**Press ▲/▼button to select the option then press OK button to enter the sub-menu.

**Use 24-hour format:**Press ▲/▼ button to select the option then press OK button to choose ON/OFF.

## TIMER

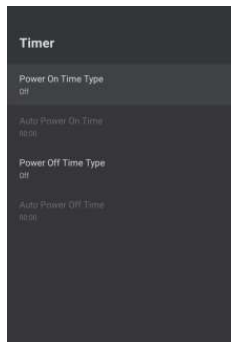

**Power On Timer Type:** Press ▲/▼ button to select the option then press OK button to choose ON/OFF/ONCE.

**Auto Power on Time:** Press ▲/▼ button to select the option then press OK button to enter the sub-menu.

**Power Off Timer Type:** Press ▲/▼button to select the option then press OK button to choose ON/OFF/ONCE.

**Auto Power Off Time:** Press ▲/▼ button to select the option then press OK button to enter the sub-menu.

## KEYBOARD

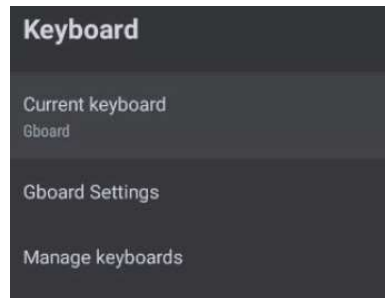

**Current keyboard:**Press ▲/▼button to select the option then press OK button to enter the sub-menu.

**Gboard Settings:** Press ▲/▼ button to select the option then press OK button to enter the sub-menu.

**Manage keyboards:** Press ▲/▼ button to select the option then press OK button to enter the sub-menu.

## INPUTS

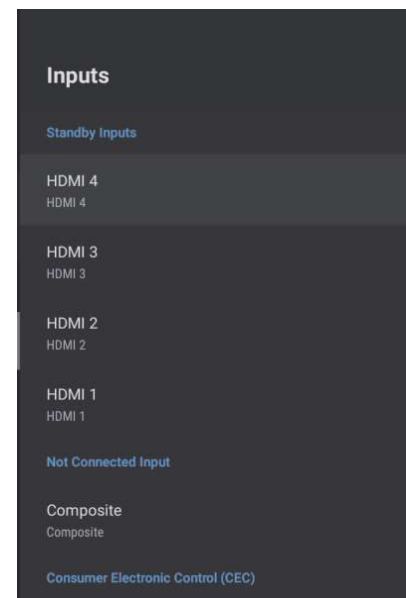

**Inputs:** Press ▲/▼button to select the option then press OK button to enter the sub-menu.

# Menu Operations

After connecting the HDMI device, click the Inputs icon at the Home Screen, you can see the name of the connected device.

Switch to the HDMI input connected to the TV, press the MENU button on the remote control, select Settings->Device Preferences-> Inputs, to access the CEC function parameters

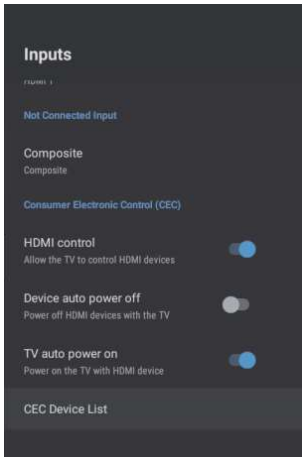

**Consumer Electronic Control (CEC)**  
This function allows to control HDMI devices through the TV unit.

**HDMI control**  
Press ▲/▼ button to select the option, then press OK button to choose ON/OFF.

**Device auto power off**  
When this option is enabled, will shutdown the HDMI source when the TV is shutdown.  
Press ▲/▼ to select the option, then press OK button to choose ON/OFF.

**TV auto power on**  
When this option is enabled, HDMI devices attached to the TV will turn on automatically at the same time as the TV unit.  
Press ▲/▼ button to select the option, then press OK button to choose ON/OFF.

**CEC Device List**  
A list of HDMI devices with CEC function ON or OFF.  
Press ▲/▼ button to select the option, then press OK button to enter the sub-menu.

## POWER

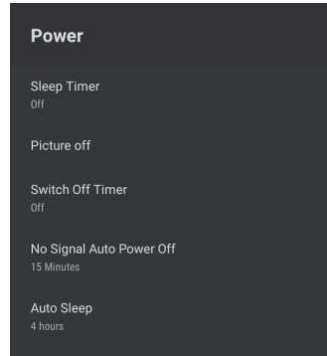

**Sleep Timer:** Press ▲/▼ button to select the option then press OK button to enter the sub-menu. (Optional: off, 10 minutes, 20 minutes, 30 minutes, 40 minutes, 50 minutes, 60 minutes, 90 minutes, 120 minutes).

**Picture off:** Press ▲/▼ button to select the option then press OK button to turn off the TV.

**Switch off timer:** Press ▲/▼ button to select the option then press OK button to enter sub-menu. (Optional: off, 30 minutes, 60 minutes, 90 minutes, 120 minutes, 150 minutes, 180 minutes, 210 minutes, 240 minutes).

**No signal Auto Power Off:** Press ▲/▼ button to select the option then press OK button to enter sub-menu. (Optional: off, 5 minutes, 10 minutes, 15 minutes, 30 minutes, 60 minutes).

**Auto Sleep:** Automatic standby function caused by no operation.

## PICTURE

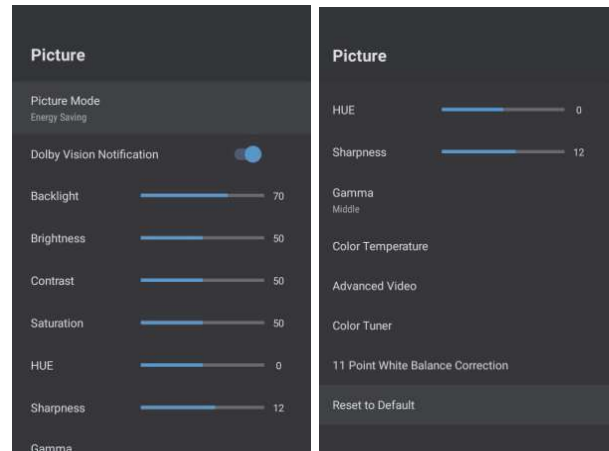

**Picture Mode:** Press ▲/▼ button to select the option then press OK button to enter sub-menu. (Optional: user, Standard, Vivid, Sport, Movie, Game, Energy saving).

**Backlight / Brightness / Contrast / Saturation / HUE / Sharpness:** Press ▲/▼ button to select the option. Press ◀ key to decrease the parameter. Press ▶ key to increase the parameter.

**Gamma:** Press ▲/▼ button to select the option then press OK button to enter sub-menu. (Optional: Dark, middle, Bright).

**Color Temperature :** Press ▲/▼ button to select the option then press OK button to enter sub-menu.

**Advanced Video :** Press ▲/▼ button to select the option then press OK button to enter the sub-menu.



# Menu Operations

## SOUND

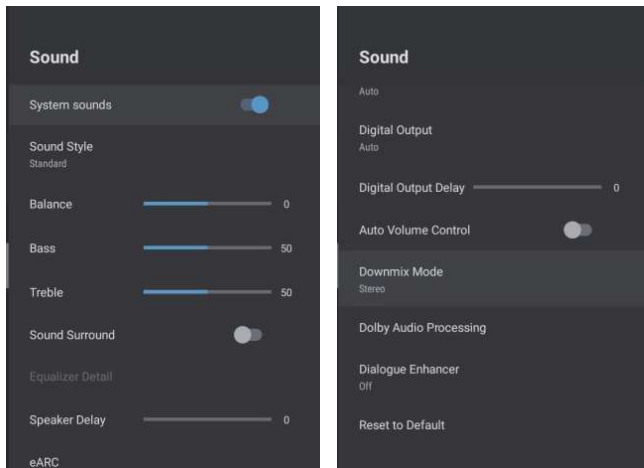

**System sound** : Press OK button to choose ON/OFF.

**Sound style** : Press ▲/▼ button to select the option then press OK button to enter the sub-menu.  
(Optional: user, Standard, Vivid, Sports, Movie, Music, News)

**Balance** : Press ▲/▼ button to select the option. press ◀ key to decrease the parameter. Press ▶ key to increase the parameter.

**Sound Surround** : Press ▲/▼ button to select the option then press OK button to choose ON/OFF.

**Equalizer Detail** : Press ▲/▼ button to select the option then press OK button to enter the sub-menu.

**Digital Output** : Press▲/▼ button to select the option then press OK button to enter the sub-menu. (Optional: Auto, Bypass, PCM, Dolby Digital Plus, Dolby Digital)

**SPDIF Delay** : Press ▲/▼ button to select the option. Press ◀ key to decrease the parameter. Press▶ key to increase the parameter.

**Auto Volume Control** : Press▲/▼ button to select the option then press OK button to choose ON/OFF.

**Downmix Mode** : Press▲/▼ button to select the option then press OK button to enter the sub-menu.  
(Optional: Stereo, Surround)

**Reset to Default** : Reset all settings to the factory defaults.

## STORAGE

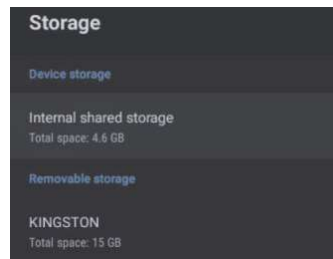

**Internal shared storage** : Press ▲/▼ button to select the option then press OK button to enter the sub-menu.

**Removable Storage** : Press ▲/▼ button to select the option then press OK button to enter the sub-menu. (Note: Show external devices if available)

## HOME SCREEN

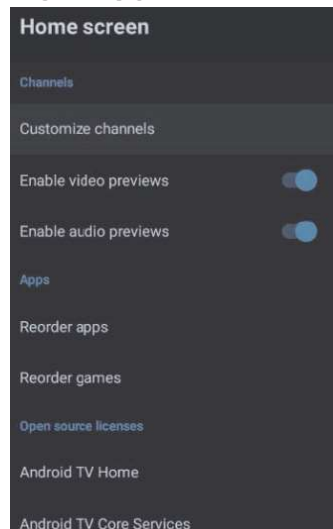

In this menu, you can set channels, apps, open source licenses.

1. Press ▲/▼ button to select what you want set.
2. Press OK button to adjust.
3. After finishing your adjustment, Press BACK button return to the previous menu.

## RETAIL MODE

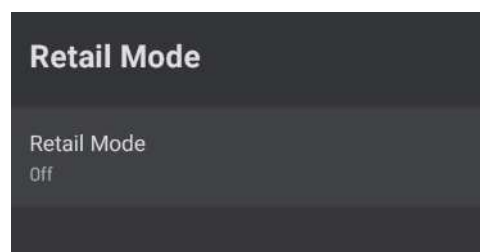

**Retail mode** : Press ▲/▼ button to select the option then press OK button to choose ON/OFF.

# Menu Operations

## GOOGLE ASSISTANT

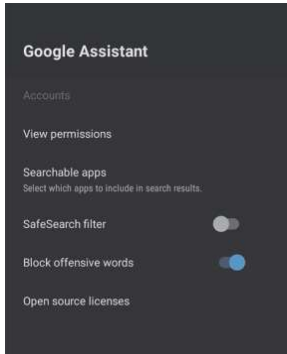

In this menu, you can set searchable apps, safe search filter, block offensive words, open source licenses.

1. Press ▲/▼ button to select what you want set.
2. Press ok button to adjust.
3. After finishing your adjustment, Press BACK button return to the previous menu.

## CHROMECAST BUILT-IN

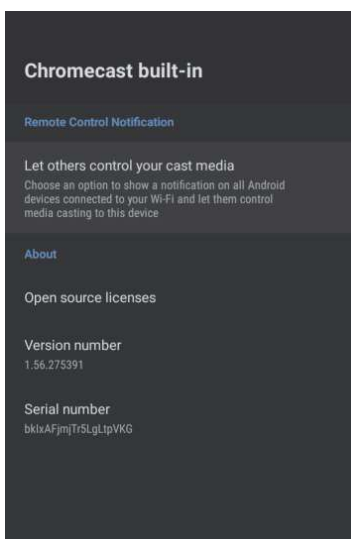

In this menu, you can read the information and settings of Chromecast.

1. Press ▲/▼ button to select what you want set.
2. Press ok button to adjust.
3. After finishing your adjustment, Press BACK button return to the previous menu.

## SCREEN SAVER

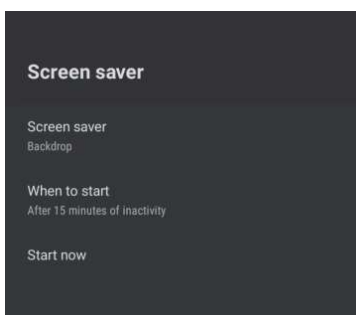

**Screen saver** : Press ▲/▼ button to select the option then press OK button to enter the sub-menu.(Optional: Turn screen off, Backdrop, Colors).

**When to Start** : Press▲/▼ button to select the option then press OK button to enter the sub-menu.(Optional: 5 minutes, 15 minutes, 30 minutes, 1 hour, 2 hours).

**Start now** : Press▲/▼ button to select the option then press OK button to enter screen saver.

## LOCATION

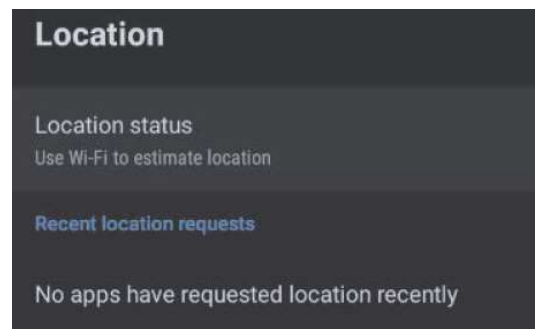

**Location status** : Press ▲/▼ button to select the option then press OK button to enter the sub-menu. (Optional: Use Wi-Fi to estimate location, Off).

## USAGE & DIAGNOSTICS

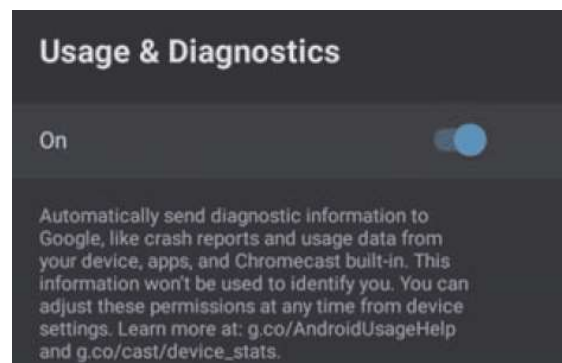

**Usage & diagnostics** : Press ▲/▼ button to select the option then press OK button to choose ON/OFF.

## ACCESSIBILITY

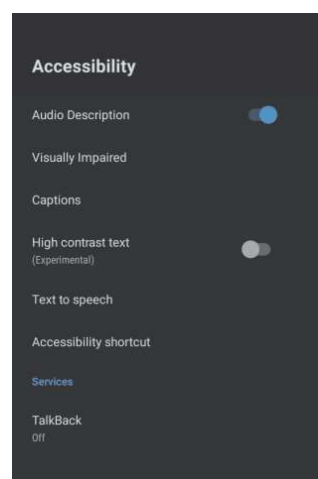

# Menu Operations

**Audio Description:** Press ▲/▼ button to select the option then press OK button to choose ON/OFF.

**Visually Impaired:** Press ▲/▼ button to select the option then press OK button to enter the sub-menu. (Need:Audio Description ON)

**Captions:** Press ▲/▼ button to select the option then press OK button to enter the sub-menu.

**High contrast text:** Press ▲/▼ button to select the option then press OK button to choose ON/OFF.

**Text to speech:** Press ▲/▼ button to select the option then press OK button to enter the sub-menu.

**Accessibility shortcut:** Press ▲/▼ button to select the option then press OK button to enter the sub-menu.

**TalkBack:** Press ▲/▼ button to select the option then press OK button to enter the sub-menu.

## RESTART

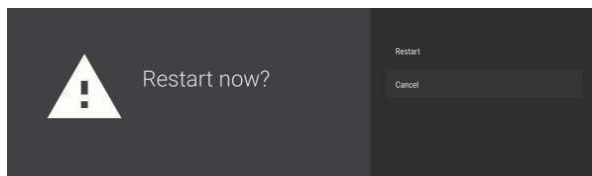

Press OK button to enter the sub-menu. Click "Restart" to restart the TV.

## REMOTE & ACCESSORIES

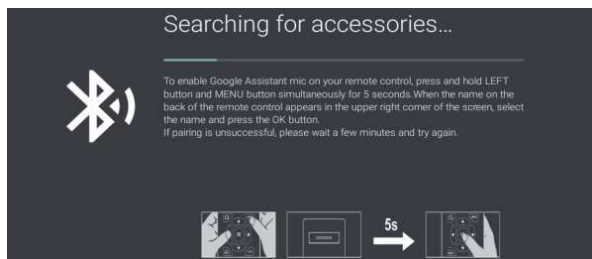

In this menu, you can pair Bluetooth devices.

1. Press the "MENU" and "LEFT" buttons at the bottom of the remote control for 5 seconds.

2. When the LED starts to flash, release it.

The remote controller will send the pairing signal to the TV and display "BT\_VoiceRC\_20\_1" on the right side of the screen.

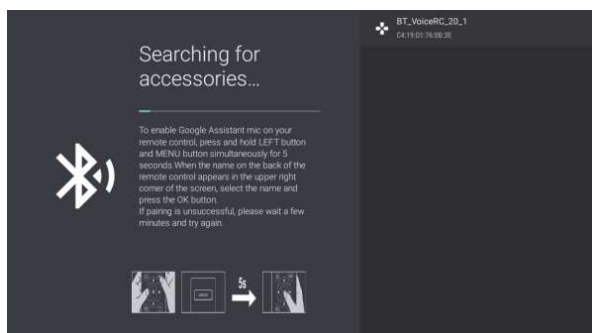

3. Press the OK button to display the pairing.

If the paired is displayed, the connection is successful.

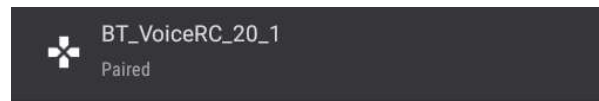

4. If the could't pair appears, the connection fails. Wait 30 seconds and then press the "MENU" and "LEFT" buttons at the bottom of the remote control for 5 seconds to repeat the previous steps.

5. Press BACK button return to previous menu.

## MULTIMEDIA PLAYER

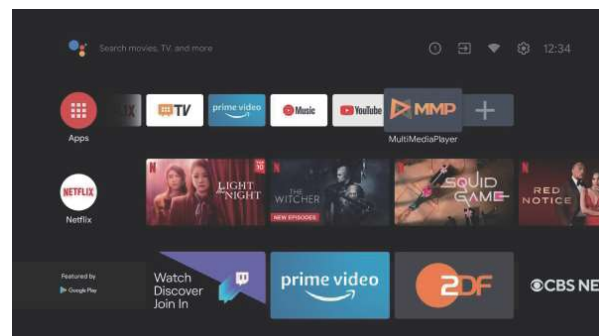

In the HOME interface, select the MMP APP to display Video, Photo, Audio, Text. After inserting the USB flash drive, you can view the corresponding files in the USB flash drive.

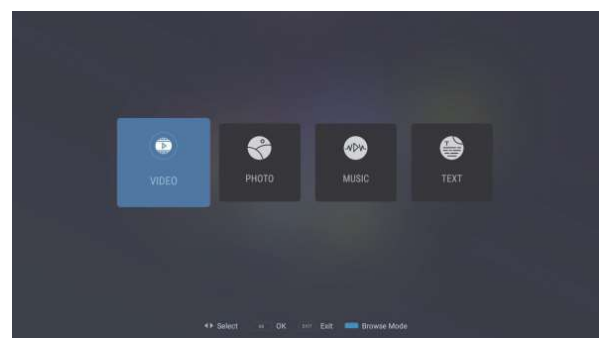

### NOTE:

The menu may be different depending on when you purchased the TV.

## Troubleshooting

If you have any problem, check the counter measures for each symptom listed below. The following symptoms may have been caused by inappropriate adjustment rather than actual malfunction of the unit. If the trouble persists, contact the Customer Care Centre, see back page for contact details.

Symptoms	Possible solutions
No power	Please check the power cord plugged in and that the power outlet works. Unplug the power cord and plug it in after 60 seconds and restart the TV.
No picture	Please check antenna connection. Station may be experiencing problems, please tune to another station. Please adjust the settings of contrast and brightness.
Good picture but no sound	Please increase the volume. Please check TV is under mute mode, press MUTE button on the remote control. Please check sound settings. If external devices are being used, check their volumes are not set too low or turned off. If using AV inputs, please make sure cables are connected properly and not loose.
Good sound but abnormal color or no picture	Please check antenna connection and antenna condition. If using AV input, please check AV connections, incorrect or loose connections may cause colour problems or cause the screen to be blank.
No response to remote control	Batteries of remote control may have exhausted, if necessary, please change the batteries. Clean the remote control lens. The distance between LED TV and remote control should be within 8m, within recommended operating angle and path is free of obstructions.
Colored dots may be present on the screen	Although the LED screen is made with high-precision technology and 99.99% or more of the pixels are effective, black dots may appear or bright points of light (red, blue, or green) may appear constantly on the LED screen. This is a structural property of the LED screen and not a malfunction.
Picture is breaking up	Keep the TV away from noisy electrical sources such as cars, hair dryers, welders, and all optional equipment. Electrical atmospheric interference such as local or distant lightning storms may cause picture to break up. When installing optional equipment, leave some space between the optional equipment and the TV. Check the antenna and connection. Keep the antenna away from any power or input/output cables.
After Auto Tuning only some channels are available	Check your area is covered by Digital Video Broadcasts. Try re-tuning or manually tuning missing channels. Check that you are using the correct antenna type - please see pg.16 'Antenna connection'.

## Troubleshooting

Channel cannot be selected	Check if the channel has been blocked in the main menu settings.
USB not playing	Please check connecting USB cable and power supply is connected. Hard drive has not been formatted. Please make sure USB disk is compatible and the multimedia data formats are supported.
Picture is distorted, macroblock, small block, dots, pixelization, etc	Compression of video contents may cause distortion especially on fast moving pictures such as sports and action movies.
Noise from speaker	Check cable connections, make sure a video cable is not connected to an audio input. Low signal level may cause sound distortion.
TV turns on automatically	Check if the On Timer is set to On in the Setup menu.
Picture is not shown in full screen	Black bars on each side will be shown on HD channels when displaying SD (4:3) contents. Black bars on Top & Bottom will be shown on movies that have aspect ratios different from your TV. Adjust picture size option on your external device or TV to full screen.

**SHARP**  
SHARP CORPORATION



# SHARP

4T-C50EK2X; 4T-C55EK2X  
4T-C60EK2X; 4T-C65EK2X  
4T-C70EK2X; 4T-C75EK2X

液晶电视/使用说明书



**HDMI™** **LED** **DVB-T2** **Dolby Vision·Atmos**

## 亲爱的夏普客户

感谢您购买夏普液晶彩电产品。为确保您的产品安全和多年无故障运行，请在使用本产品前仔细阅读重要安全注意事项。

## 目录

安全和注意事项.....	1-5
产品清单.....	6
安装电视机.....	7-10
安装壁挂.....	11
使用电视机.....	12-14
连接外接设备.....	15-17
电视机主体操作.....	18-26
疑问解答.....	27-28

## 安全和注意事项

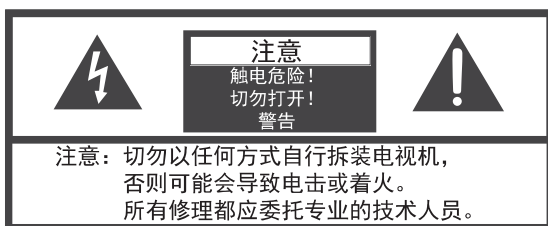

切勿在暴雨尤其有雷电时使用电视机，以防雷击。



注意设备随附的文献中存在重要的操作和维护（维修）说明。

**警告：**切勿将电视电视机放置于潮湿的环境，否则可能会引起着火和触电等危险。切勿将明火（例如点燃的蜡烛）靠近电视机，否则可能引起触电或火灾。

**注意：**防止触电。请勿将此极化插头与延长线、插座或其他插座一起使用，除非刀片可以完全插入以防止刀片暴露。

### FCC声明

本设备经测试证明符合 FCC 规则第15部分对B类数字设备的限制。这些限制旨在提供合理的保护，防止住宅安装中的有害干扰。本设备会产生、使用和辐射射频能量，如果未按照说明安装和使用，可能会对无线电通信造成有害干扰。

但是，不能保证在特定安装中不会发生干扰。如果此设备确实对无线电或电视接收造成有害干扰，可以通过关闭和打开设备来确定，鼓励用户尝试纠正

通过以下一项或多项措施进行干扰：

- 重新调整或摆放接收天线。
- 增加设备和接收器之间的距离。
- 将设备连接到与接收器不同的电路上的插座。
- 向经销商或有经验的无线电/电视技术人员寻求帮助。

**注意：**未经允许或授权更改FCC规则，可能会导致用户操作此设备的权限失效。

本设备符合FCC规则的第15部分，操作受以下两个条件的约束：

- (1) 本设备可能不会造成有害干扰，并且
- (2) 本设备必须接受接收到的任何干扰，包括可能导致意外操作的干扰。

### 电缆：

必须使用带有金属RF/EMI连接器罩的屏蔽电缆连接到此设备，以保持符合 FCC 规则和法规。

### 5GHz频段的限制：

在5150-5250MHz频段运行的设备仅适用于室内使用，以减少对同频道移动卫星系统造成有害干扰的可能性。

### 重要提示：

在下面的空白处输入您的电视机的型号和序列号（位于电视机柜的后部）。将您的销售收据或发票装订到本指南的内页。将此用户指南保存在方便的地方以备将来参考。保留纸箱和原包装以备将来使用。

### 所需标记的位置

额定值表和安全注意事项位于电视机背面。

### 电池注意事项：

- 电池不应暴露在过热的环境中，如日晒等。
- 遥控器使用红外光束传输信号，因此遥控器上的阳光或荧光灯可能会缩短操作距离。
- 电池使用不当可能导致漏电或爆裂。请阅读电池警告并正确使用电池。
- 不要混用新旧电池。
- 请勿混用碱性标准（碳锌）或可充电（Ni-CdNi-MHetc）电池。
- 如果长时间不操作遥控器，请取出电池。

序列号：\_\_\_\_\_

型号：\_\_\_\_\_



## 安全注意事项

- 1) 阅读这些说明
- 2) 保留这些说明。
- 3) 注意所有警告。
- 4) 遵循说明。
- 5) 不要在水附近使用此电视机。
- 6) 只能用于布清洁。
- 7) 按照制造商的说明安装，不要堵塞任何通风口。
- 8) 不要接近任何热源，例如：散热器热寄存器炉或其他设备（包括产生热量的放大器）
- 9) 不要破坏极化或极化的安全目的接地型插头。极化插头有两个刀片，一个比另一个宽。接地型插头有两个刀片和一个第三接地插脚。宽刀片或第三插脚为您的安全而提供。如果提供的插头不适合您的插座，请咨询电工以更换过时的插座。
- 10) 保护电源线不被踩到或夹住，特别是在插头方便插座处，以及它们从设备中退出的位置。
- 11) 仅使用制造商指定的附件/附件。
- 12) 仅在装有推车支架三脚架支架的情况下使用由制造商指定或与设备一起出售。使用推车时，移动推车/设备组合时要小心，避免因翻倒而受伤。



- 13) 在雷雨天气或长时间不使用时，请拔下本设备的插头。
- 14) 将所有维修工作交由合格的维修人员进行。当仪器有任何损坏时，如电源线或插头损坏、液体溅出或物体掉入仪器内，都需要维修，或设备被雨淋或受潮、无法正常工作或跌落。
- 15) 墙壁插头是断开装置。插头必须保持易于操作。
- 16) 遥控器电池不应暴露在阳光、火源等过热环境中。根据当地现行的环境法律和准则，及时正确地处理废旧电池。

### 小心：

如果更换的电池类型不正确，可能会引发火灾或爆炸。

- 17) 仪器不应暴露在滴水或溅水环境中，不得在仪器上放置盛有液体的物体，如花瓶。
- 18) 禁止明火，例如点燃的蜡烛，应放置在设备上。
- 19) 您的电视背面有四个 VESA 安装孔。如果您将壁挂式支架或电视支架连接到电视背面，则必须使用所有四个孔牢固地连接支架或支架。如果您不使用所有四个安装孔，您的电视可能会掉落并导致财产损失或人身伤害。有关完整的安装说明，请参阅壁挂支架或电视支架随附的文档。

### 警告

耳机和耳机的过大声压会导致听力损失

### 注意

双极，中性熔断器。  
维修前断开电源。



此符号表示本产品在高电压电源电压和用户可触及部件之间采用双重绝缘。  
维修时仅使用相同的替换零件。

## 安全注意事项

### 警告

#### 1) 稳定性危害

电视机可能会掉落，造成严重的人身伤害或死亡。切勿将电视机放置在不稳定的位置。

电视机可能会跌落，造成严重的人身伤害或死亡。采取简单的预防措施可以避免许多伤害，尤其是对儿童的伤害，例如：

- 使用电视机制造商推荐的机柜或支架。
- 仅使用可以安全支撑电视机的家具。
- 确保电视机没有伸出支撑家具的边缘。
- 如果没有将家具和电视机都固定在合适的支撑物上，请勿将电视机放置在高大的家具上（例如，橱柜或书柜）。
- 不要将电视机放在电视机和支撑家具之间的布或其他材料上。
- 教育孩子们攀爬的危险

在家具上以接触电视机或其控制装置。

如果您现有的电视机被保留和搬迁，则应采用与上述相同的注意事项。

2) 为降低火灾或触电的风险，请勿取下任何盖子或将设备暴露在雨中或潮湿环境中。设备内部没有用户可维修的部件。请给合格的维修技术人员进行维修。

3) 完成此设备的任何服务或维修后，请服务技术人员执行例行安全检查，以确定您的电视处于正确的操作状态。

4) 这些维修说明仅供合格的维修人员使用。为降低触电风险，除非您有资格，否则请勿执行操作说明以外的任何维修。

5) 需要更换零件时，请确保维修技术人员使用制造商指定的与原零件具有相同特性的更换零件。未经授权的替换可能会导致重新、触电、人身伤害或其他危险。

6) 如果外部天线或电缆系统连接到您的电视，请确保天线或电缆系统接地，以防止电压浪涌和积聚的静电荷。美国国家电气规范第 810 条，ANSI/NFPA No. 70，提供有关桅杆的正确接地和支撑桅杆和支撑结构的正确接地、引入线到天线放电单元的接地、接地导体的尺寸、天线放电单元的位置、连接的信息 对接地电极，以及对接地电极的要求。

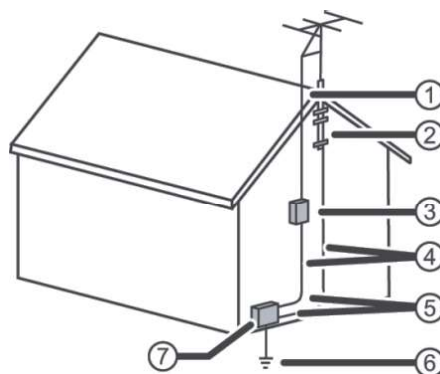

- (1) 天线引入线
- (2) 接地夹
- (3) 天线放电单元
- (4) 接地导体
- (5) 接地夹 电源服务
- (6) 接地极系统
- (7) 电力服务设备

#### 7) CATV 系统安装人员注意事项

美国国家电气规范第 820 条，ANSI/NFPA No. 40 提供了正确接地的指导。具体来说，它规定电缆接地必须尽可能靠近电缆入口点连接到建筑物的接地系统。

8) 外部天线系统不应位于架空电力线或其他电灯或电源电路附近，或可能落入此类电源线或电路的地方。安装外部天线系统时，请格外小心，不要接触此类电源线或电路，因为接触它们可能会致命。

9) 您的电视屏幕由玻璃制成。请勿掉落电视机或撞击、摇晃或用力按压 LCD 面板。如果屏幕破裂，请小心碎玻璃。如果 LCD 面板损坏，请绝对确保不要触摸面板中的液体。这可能会导致皮肤发炎。如果液体进入您的口中，请立即漱口、冲洗并咨询您的医生。此外，如果液体进入您的眼睛或接触到您的皮肤，请用清水冲洗至少 15 分钟或更长时间后咨询您的医生。

## 安全注意事项

10) 从电源插座上拔下这台电视并参考

在以下条件下由合格的维修人员进行维修：

- 当电源线或插头损坏或磨损时。
- 如果液体溅出或物体掉入电视机。
- 如果您的电视机被雨淋或淋水。
- 如果按照操作说明您的电视机无法正常运行。仅调整操作说明中涵盖的控件，因为其他控件的错误调整可能会导致损坏，并且通常需要合格的技术人员进行大量工作才能将电视恢复到正常运行状态。
- 如果您的电视机曾以任何方式跌落或损坏。
- 当您的电视表现出明显的性能变化时。

11) 仅使用标记标签上标明的电源类型操作您的电视。如果您不确定为您家提供的电源类型，请咨询电工或当地电力公司。

12) 如果将电视机从凉爽的环境带入温暖的房间或房间温度突然升高，电视机上会形成湿气。发生这种情况时，电视的性能可能会受到影响。

为防止出现这种情况，请在打开电视前让电视在新环境中放置约一小时，或确保室温逐渐升高。如果电视暴露在空调吹出的微风中，夏季也可能会形成冷凝水。在这种情况下，请更改电视的位置。

13) 您的电视可能包含因环境原因而受到管制的材料。您的电视还包含可回收和再利用的材料。为帮助保护环境，请联系您当地的政府部门，了解有关处置或回收的信息，以及在您处置电视之前在您所在地区寻找回收商的信息。

14) 为避免干扰您的电视图像和声音、操作问题甚至损坏，请将您的无线电话和手机远离电视。

15) LCD 面板包含近 300 万个薄膜晶体管，可提供十分清晰的视频质量。偶尔，一些非活动像素可能会在屏幕上显示为固定的蓝色、绿色或红色点。这些非活动像素不会对电视的性能产生不利影响，也不被视为缺陷。

## 安全注意事项

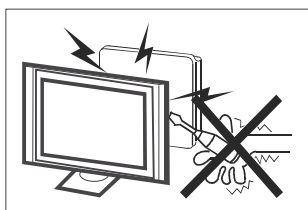

此电视接收器的操作使用高压。请勿将机柜从您的电视机中取出。  
请给合格的维修人员进行维修。

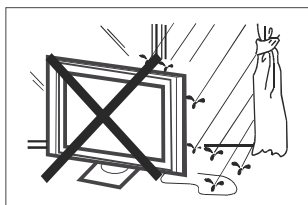

为防止火灾或触电危险，请勿将电视接收机暴露在雨中或受潮。

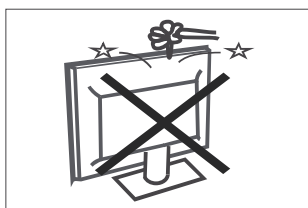

请勿将物体掉落或推入电视柜插槽或开口。切勿将任何液体溅到电视接收器上。

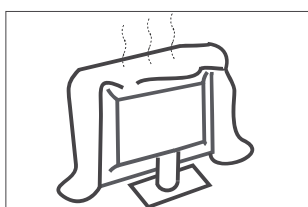

请勿堵塞后盖上的通风孔。充足的通风对于防止电气元件故障至关重要。

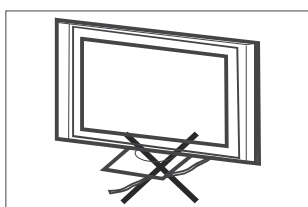

请勿将电源线夹在电视接收器下方。

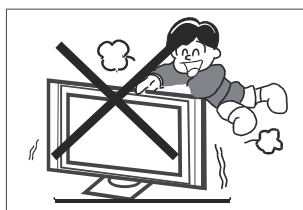

切勿站立、靠在或突然推动电视机或其支架。您应特别注意儿童。  
如果跌落，可能会造成严重伤害。

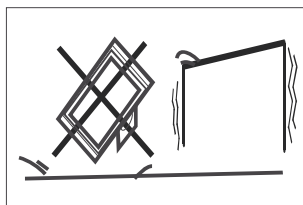

不要将电视机放在不稳定的推车、支架、架子或桌子上。如果跌落，可能会导致严重的人身伤害和电视机损坏。建议使用后置螺丝孔防倾翻（不包括硬件）。



长时间不使用电视接收机时，建议从交流电源插座上拔下交流电源线。

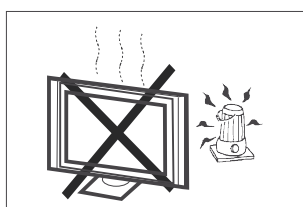

避免将电视接收器暴露在阳光直射和其他热源下。请勿将电视接收器直接放在其他会发热的产品上，例如盒式磁带播放器和音频放大器。请勿在电视机上放置明火源，例如点燃的蜡烛。

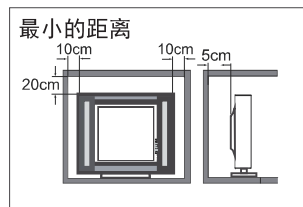

如果电视要安装在隔间或类似的外壳中，则必须保持最小距离。热量积聚可能会缩短电视机的使用寿命，也可能很危险。

# 产品清单

## 天线

### 主要特点

- 宽屏幕带来完整的家庭影院体验。
- 超薄液晶电视，带LED背光。
- 用于HDTV广播接收的集成DVB-T2电视调谐器。
- HDMI 输入，用于真正的数字连接。

### 配件

- 遥控器.....1
- 用户说明书.....1
- 电池(AAA).....2
- 螺丝.....4
- 底座支架.....2
- 垫片.....2 (仅适用于 4T-C50EK2X 型号)

### 规格

尺寸	50"class 50"diagonal	55"class 55"diagonal	60"class 60"diagonal	65"class 65"diagonal	70"class 70"diagonal	75"class 75"diagonal
分辨率	3840 x 2160					
纵横比	16:9					
电视系统	DVB-T/T2/C					
视频信号系统	NTSC, PAL, SECAM					
功耗	135W	150W	165W	170W	220W	260W
输入电压	100-240V~, 50/60Hz					
音频输出功率 (THD≤10%)	2x10W					
高清多媒体接口 (HDMI) 输入	x 4					
接口输入 (迷你)	x 1					
耳机输出	x 1					
光纤输出	x 1					
网口	x 1					
USB 2.0接口输入	x 2					



The terms HDMI, HDMI High-Definition Multimedia Interface, and the HDMI Logo are trademarks or registered trademarks of HDMI Licensing Administrator, Inc.



Dolby, Dolby Vision, Dolby Atmos, and the double-D symbol are registered trademarks of Dolby Laboratories Licensing Corporation. Manufactured under license from Dolby Laboratories. Confidential unpublished works. Copyright © 2012–2022 Dolby Laboratories. All rights reserved.

# 安装电视机

## 电视机正面

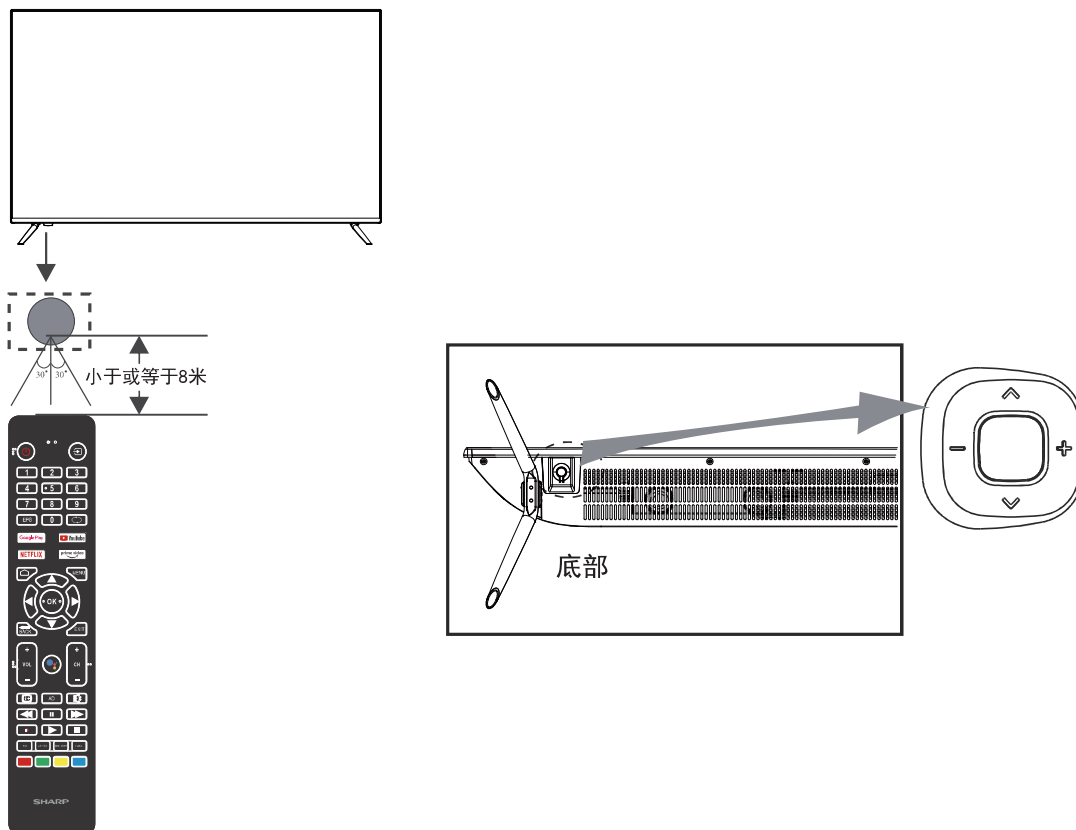

## 遥控器

1. 电视开机后，长按本地键3S以上进入待机。

2. 第三方应用，主场景和USB，只有在

1) 检测到以上，不执行以下3个操作。

3. 按本地键不超过3S，进入本地键菜单。

本机键菜单包括开/关、节目+、节目-、音量+、音量-、节目源六个选项；

a) 显示本地按键菜单时，按键时间小于1.5s，焦点依次向后移动一次；

b) 显示本地按键菜单时，长按键时间大于1.5s，执行进入当前焦点选项的功能。

## 后端子连接



所有端子（从左到右）：

ETHERNET, OPTICAL, USB, HDMI 4, HDMI 3, HDMI2, Mini AV INPUT, RF。

## 侧端子连接



所有的终端是（从左到右）：

USB2.0, HDMI1（eARC/ARC），耳机。

# 安装电视机

## 连接天线

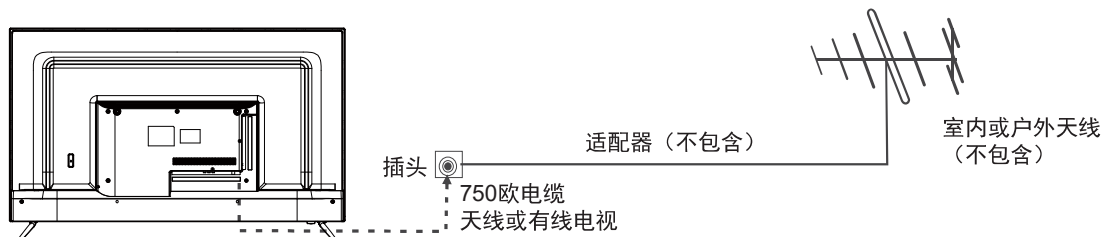

注意：  
天线连接器：IEC 连接器。  
输入阻抗：75Ω不平衡。

本机的天线输入阻抗为 75ohm。VHF/UHF 75ohm 同轴电缆可以直接连接到天线插孔。

## 带有75Ω圆形引线的天线

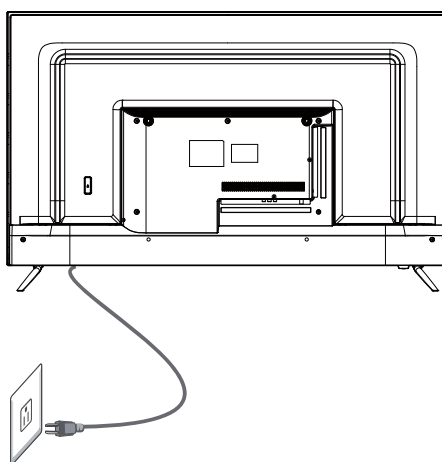
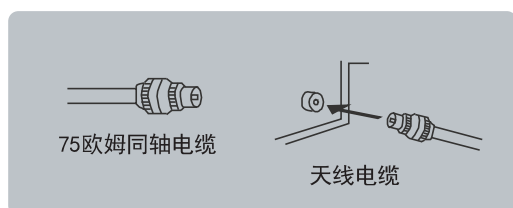

## 电源连接

请注意：打开包装后，让电视达到室温，然后再将电视连接到电源插座。  
将电源线插头连接到电源插座。

## 电缆

出厂时，信号类型选项适用于设置为“**AIR**”（空中天线）模式的射频连接器（**F**型）。

# 安装电视机

## 底座组装说明

### 底座安装

准备将电视机的显示屏面朝下放在平坦的表面上。由于此电视的尺寸和重量，建议在移动时使用2人。确保您使用的桌子或书桌提供平坦、完全清洁的表面，并在电视正面和桌子之间使用软布保护电视屏幕。

1. 找到2个底座并将其插入电视底部的缝隙中，并检查它是否牢固地固定到位，如下所示。

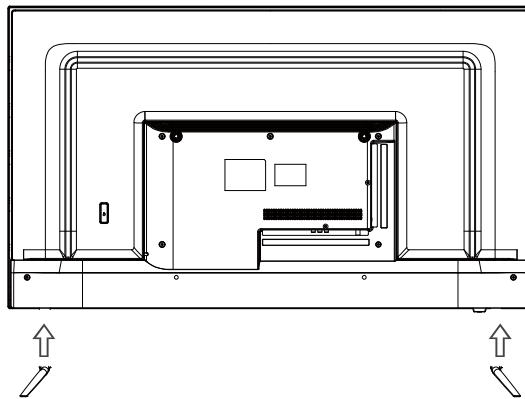

2. 将 4/6 颗螺丝锁在如下指定位置，并检查每颗螺丝是否拧紧。

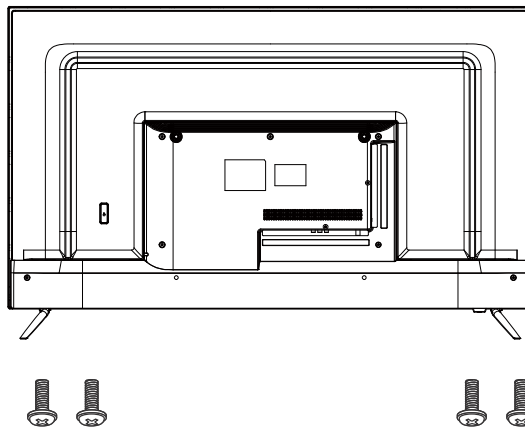

50"/55"(M4x28mm)x4  
60"/65"/70"(M4x14mm)x6  
75"(M6x40mm)x4



# 安装电视机

## 视听设备

您可以按如下方式使用背面输入端子。

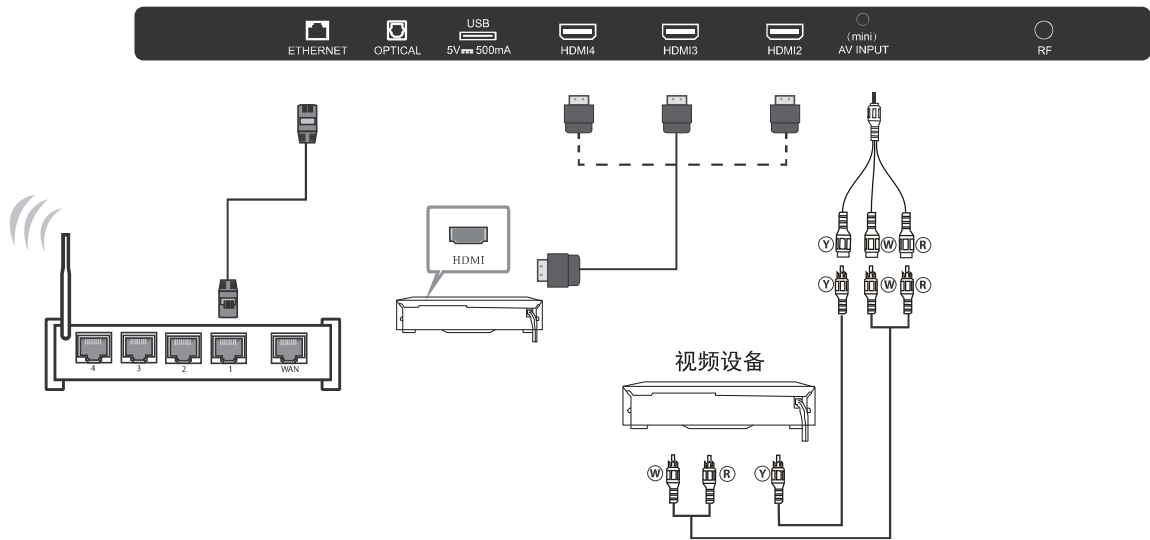

1. 接地
2. 左声道
3. 右声道
4. 视频

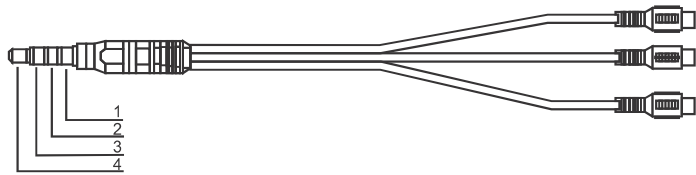

黄线（视频）  
白线（左声道）  
红线（右声道）



注意：  
不支持带麦克风的耳机，请仅插入耳机。

视频设备：录像机、多碟播放器、DVD 播放器、摄像机、视频游戏等。

# 安装壁挂

## 壁挂安装说明

1. 将 LED 液晶电视放在坚固的表面上。请在屏幕正面放置一些柔软的材料，以保护它免受任何损坏。

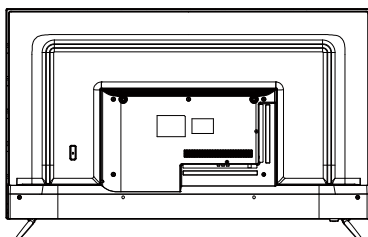

2. 使用提供的四颗螺钉通过电视背面的四个 VESA 标准孔将电视固定到壁挂支架（不包含）上。

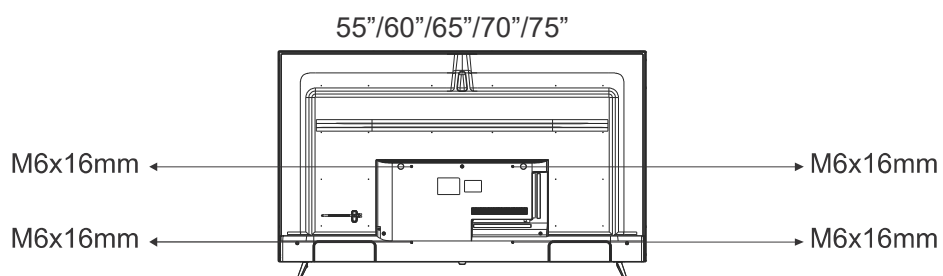
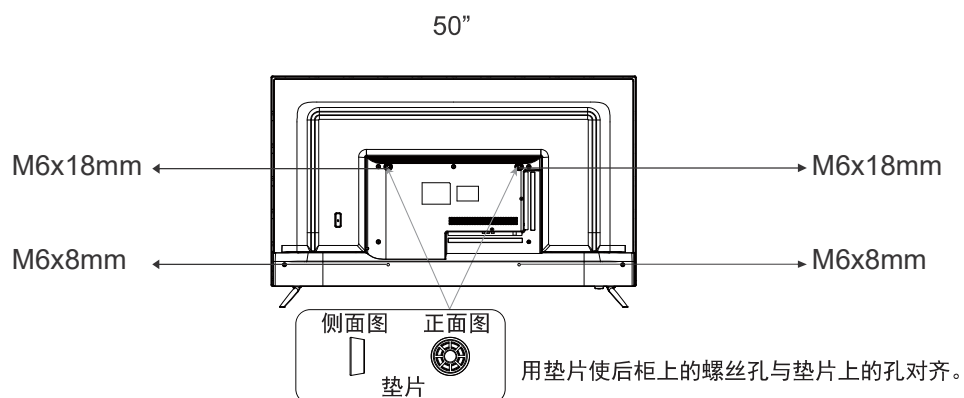

# 使用电视机

## 安装遥控器电池

### 安装电池

**1** 打开背面的电池仓盖。



**2** 以正确的极性插入两节 1.5V AAA 电池。请勿将旧电池或用过的电池与新电池混用。



**3** 合上后盖

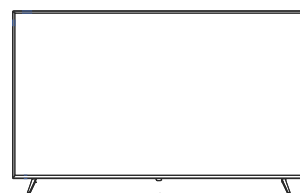

✦ 将遥控器对准电视的遥控感应器，并在 8 米范围内使用。

✦ 将用过的电池放入回收箱，因为它们会对环境产生负面影响。

### 注意：

正常使用情况下，一次装入电池可持续使用1年。

如果您打算长期不使用遥控器，请将其取下，以免因漏液而损坏。

请勿同时使用新旧电池。

电池（电池组或安装的电池）不得暴露在阳光、火等过热环境中。

## 使用电视机

### 遥控器操作



#### 装载电池：

- 1) 取下电池仓盖。
- 2) 插入 2 节 AAA 电池，其极性如电池盒内所示。
- 3) 装上盖子。

#### 注意：

- 1) 正常使用情况下，一次装电池应能使用一年。
- 2) 如果您打算长期不使用遥控器，请将电池取出，以免因漏液而损坏。
- 3) 请勿混用新旧电池或不同类型的电池。
- 4) 请勿将电池投入火中或水中。
- 5) 电池（电池组或安装的电池）不应暴露在阳光、火等过热环境中。

# 使用电视机

## 遥控器概述

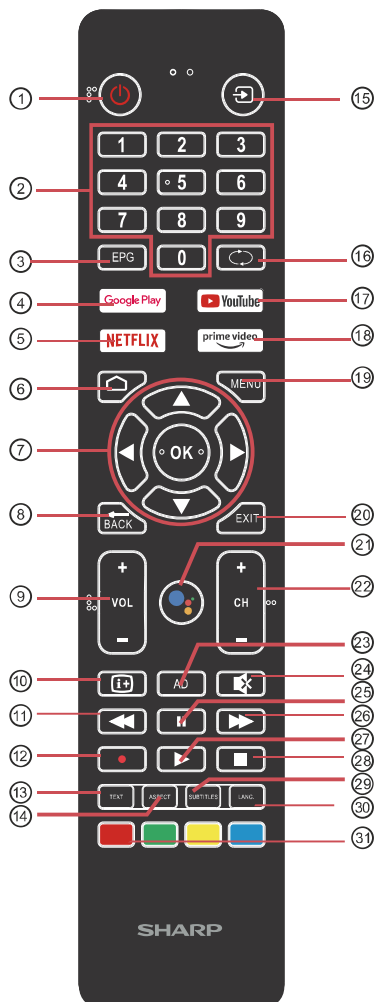

1. POWER: 将电视设置为待机或开机模式。
2. NUMERIC KEY: 用于直接访问频道。
3. EPG按钮: 在该模式下按下显示电子节目指南。
4. GOOGLE PLAY 按钮: 按下可访问 Google Play 影视 (需要联网)。
5. NETFLIX 按钮: 连接到 Netflix 以观看在线电视节目和电影 (需要联网)。
6. : 按打开首页。
7. OK: 确认选择。  
▲▼◀▶: 按下可浏览屏幕菜单。
8. Back: 返回上一级菜单。
9. Vol +/-: 调整音量。
10. : 按下显示频道信息。
11. ◀◀ (反向): 快速反向播放。
12. ● (刻录): 刻录功能。
13. TEXT: 按下选择图文电视模式。
14. ASPECT: 按下改变图片的纵横比。
15. : 选择不同的输入信号源。
16. : 跳到上一个观看的频道。
17. YOUTUBE 按钮: 按下以访问 YouTube (需要联网)。
18. PRIME VIDEO 按钮:  
连接至 Prime Video 以观看在线电视节目和电影 (需要互联网连接)。
19. 菜单: 按下可打开或关闭屏幕菜单。
20. 退出按钮: 按下退出菜单或应用程序。
21. 谷歌助手: 按下打开谷歌助手或开始语音搜索。
22. CH+/CH-: 访问下一个或上一个频道。
23. AD按钮: 打开或关闭音频描述。
24. 静音按钮: 按下静音或取消静音。
25. (暂停): 暂停播放。
26. (前进): 快速前进播放。
27. (播放): 开始播放。
28. (停止): 按下停止多媒体播放。
29. SUBTITLES: 在 DTV 模式下打开字幕。
30. LANG.: 如果可用, 请选择替代语言。
31. 彩色按钮: 根据文本中菜单底部的提示进行相关操作。

## 连接外接设备

### 连接摄像机

电视上的后面板插孔可让您轻松将摄像机连接到电视。它们允许您在不使用 VCR 的情况下查看摄像机录像带。

每台摄像机都有不同的后面板配置。连接摄像机或 DVD 时，连接端子的颜色需与电缆相匹配。

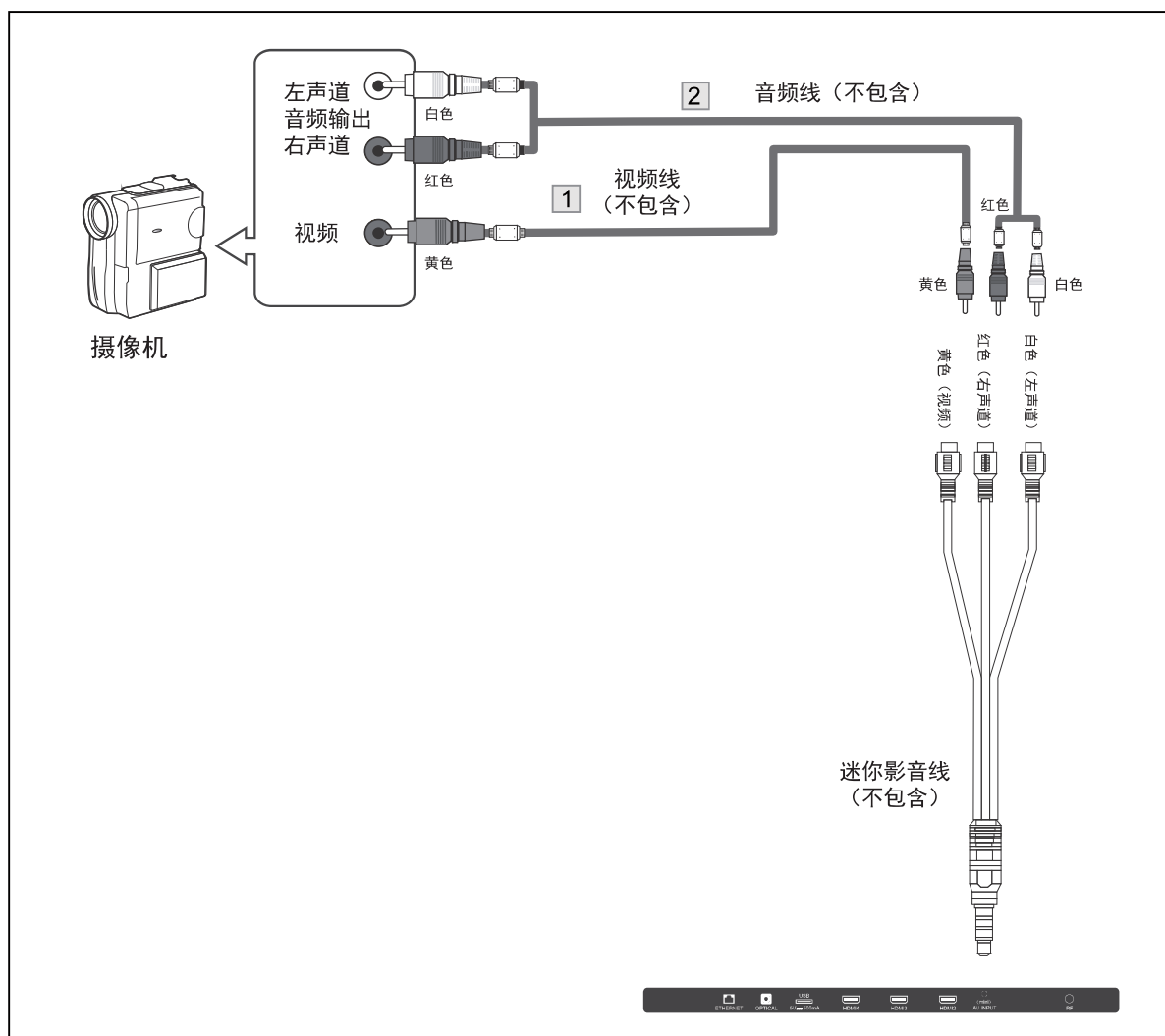

- 1) 将 Mini AV 电缆连接到此电视上的 mini 插孔端子。  
接下来
- 2) 将摄像机的 AV 视频线和音频线分别连接到此 Mini AV 线的“AV INPUT”和“AUDIO L 和 R”。

注意：

1. 将外部设备连接到电视时，请确保关闭设备电源。
2. 连接外部设备时，将连接端子的颜色与电缆相匹配。

## 连接外接设备

### 连接 DVD 播放器/机顶盒

仅当外部设备上有 HDMI 输出连接器时才能进行此连接。

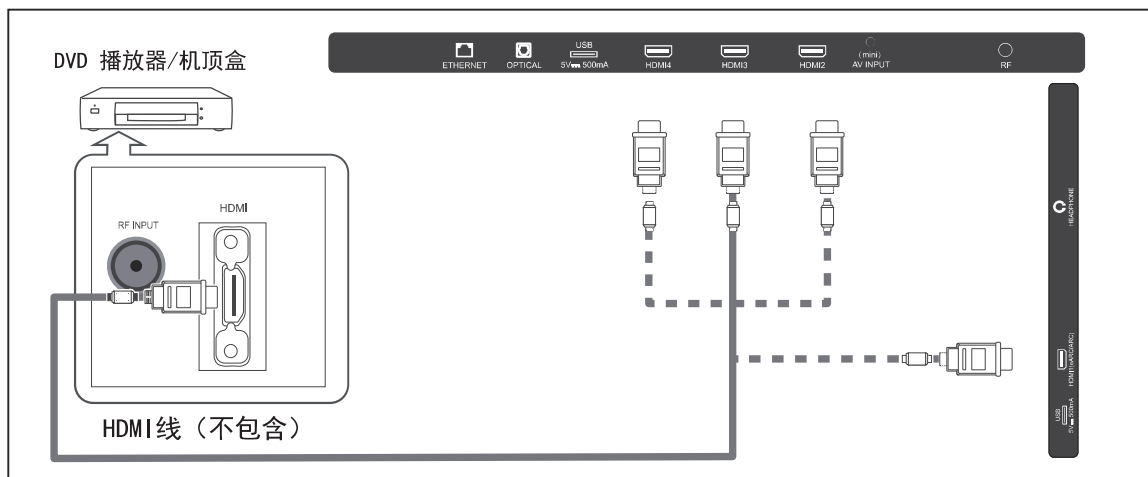

#### 什么是HDMI？

HDMI 或高清多媒体接口是下一代接口，可以使用单根电缆传输数字音频和视频信号而无需压缩。多媒体接口是一个更准确的名称，尤其是因为它允许许多通道数字音频（5.1 通道）。

HDMI和DVI的区别在于HDMI设备体积更小，安装了 HDCP（High Bandwidth Digital Copy Protection）编码功能，支持多声道数字音频。

每个 DVD 播放器/STB 都有不同的后面板配置。

在电视上的 HDMI1、HDMI2、HDMI3、HDMI4 连接器和 DVD 播放器/机顶盒上的 HDMI 连接器之间连接一根 HDMI 电缆。

使用 ARC 时，将兼容 ARC 的外部设备连接到 HDMI 1，在 Live TV 下，按“MENU”按钮选择“Speaker”、“External Audio System”。

#### 注意：

1. 将外部设备连接到电视时，请确保关闭设备电源。
2. 连接外部设备时，将连接端子的颜色与电缆相匹配。

## 连接外接设备

### 连接数字音频系统

电视上的后面板插孔可轻松将数字音频系统连接到电视。

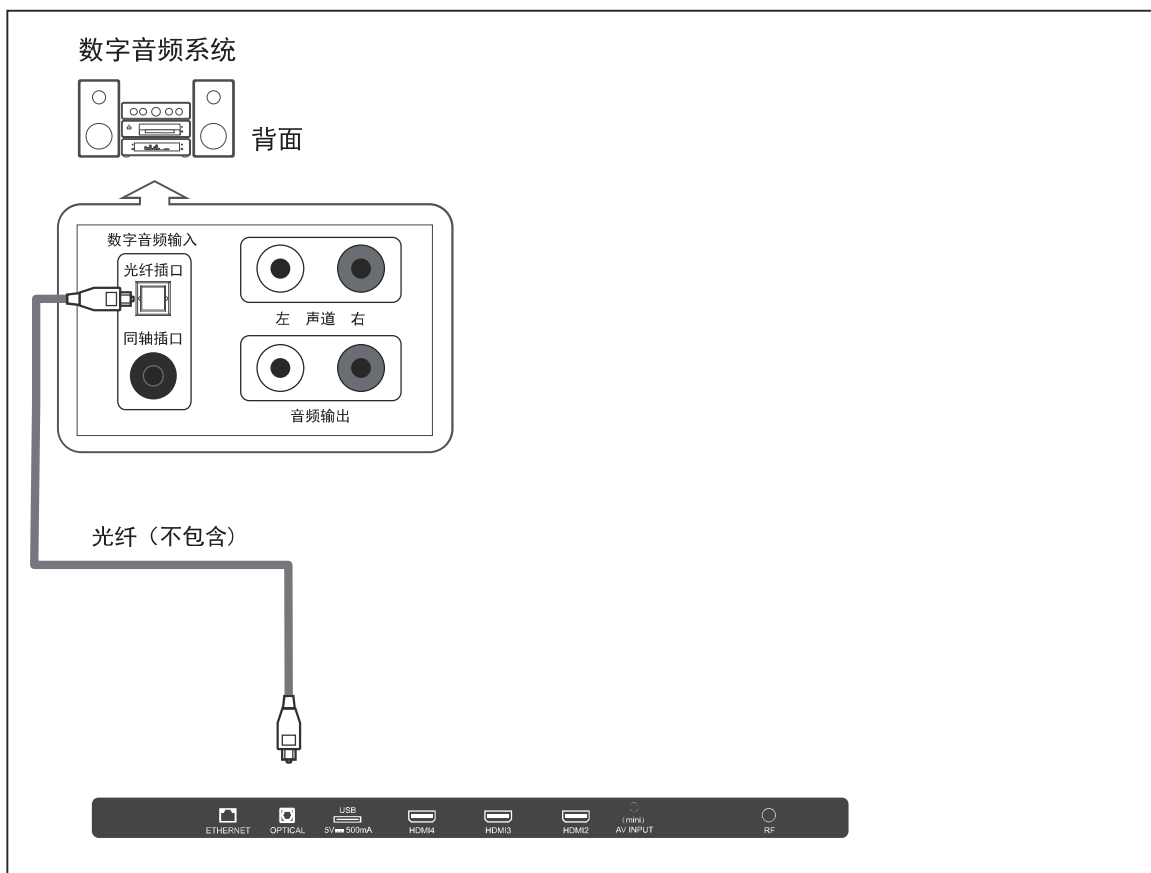

当电视连接到支持 5.1 频道的外部设备时，可以播放 5.1 频道音频。

在电视上的 光纤插孔和数字音频系统上的数字音频输入插孔之间连接一根 光纤 电缆。当数字音频系统连接到 光纤 端子时：降低电视的增益（音量），并使用数字音频系统的音量控制调节音量。

### 支持的信号

输入	系统	分辨率
AV	NTSC	480i
	PAL	576i

输入	模式
RF	DVB-T/T2/C
	PAL/NTSC(Analog)

输入	分辨率	垂直频率
HDMI	720p	50Hz/60Hz
	1080i	50Hz/60Hz
	1080p	50Hz/60Hz
	3840x2160	24Hz/25Hz/30Hz/60Hz



# 电视机主体操作

## 引导设置

第一次打开电视，设置向导将引导您完成基本设置。请根据第一次设置的文本提示。



按▲/▼选择系统语言，然后按OK确认语言。如果您使用的是红外遥控器，请忽略文本提示并按返回按钮退出此页面。

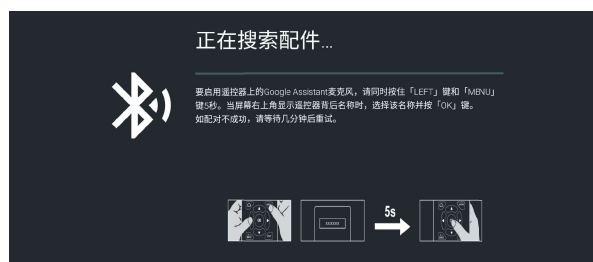

该功能用于遥控器配对。要启用遥控器上的 Google Assistant 麦克风，请同时按住左按钮和菜单按钮 5 秒钟。当屏幕右上角出现“BT\_VoiceRC\_20\_1”时，选择名称并按“OK”按钮。

配对成功后，即可使用蓝牙遥控器对电视进行操作。



将您的安卓手机连接到电视，选择继续连接，再选择跳过此步骤。

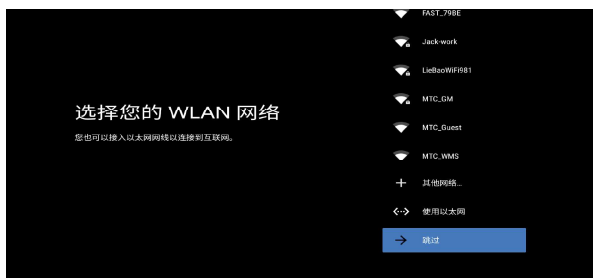

按▲/▼选择要连接的Wifi，按OK并输入密码确认连接成功。Wi-Fi 路由器的推荐设置：为了获得最佳质量、性能和可靠性，我们建议为 Wi-Fi 路由器选择 5Ghz 频段设置。



通过接受 Google 服务条款以改善产品体验，请选择“接受”以接受此条件。



单击“接受”以确认您选择这些 Google 服务设置。

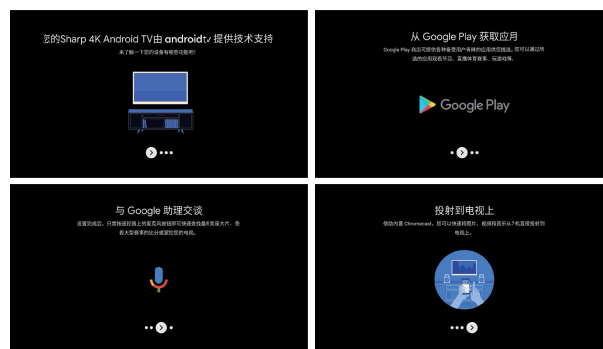

1. 您的设备由 Android TV 供电，按▶键选择浏览功能。
2. 您可以从 Google Play 获取更多应用程序，然后按▶键进入下一个屏幕。
3. 通过内置的chromecast将照片等内容传输到电视上，按OK完成浏览。

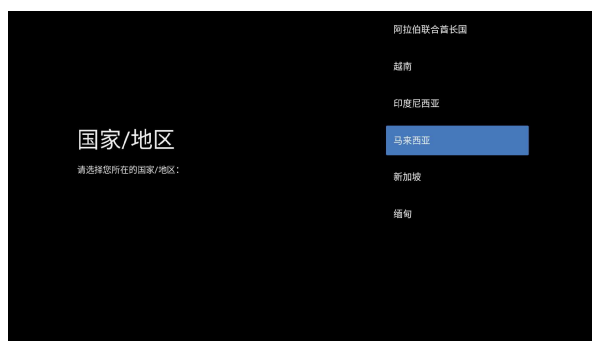

按▲/▼键选择您所在的地区或国家。

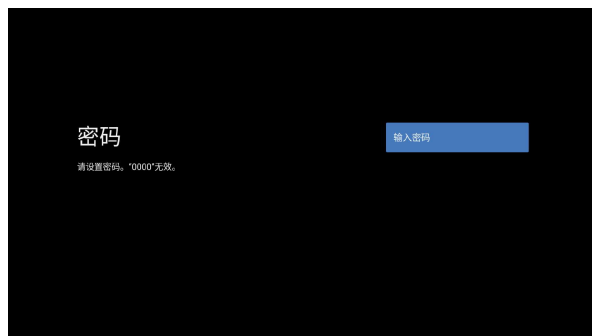

用于设置您设备的密码以确保安全和隐私。

# 电视机主体操作



选择模式时，按 ▲/▼ 键选择 Home 模式，然后按 OK 确认



按 ▲/▼ 键打开或关闭 chromecast 始终可用的功能。

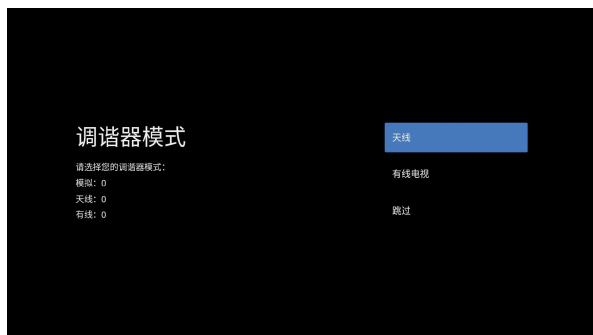

要选择调谐器模式进行搜索，按 ▲/▼ 键选择并按 OK 确认。

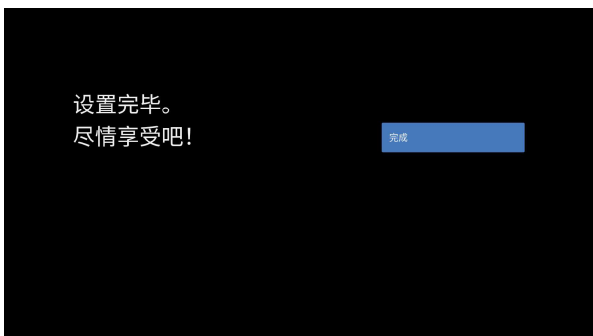

按 OK 完成设置。

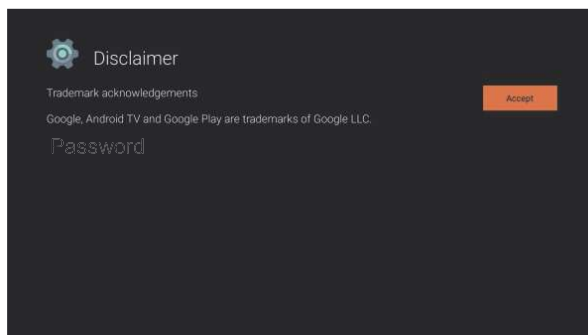

按确定同意免责声明。  
设置完成后，就可以看电视了。

## 主屏幕

按 HOME 按钮进入 HOME 页面。

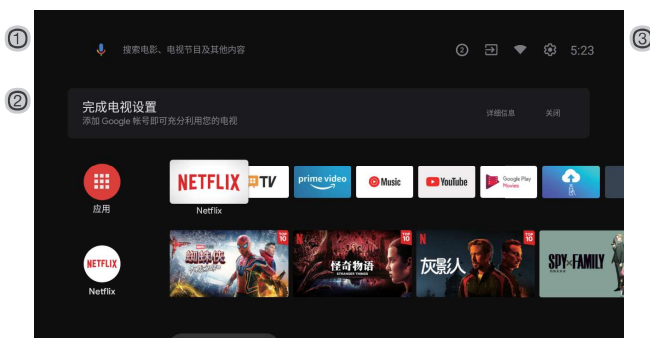

- ① 打开谷歌助手或开始语音搜索。
- ② 在电视上安装的应用程序中，最喜欢的应用程序的图标在这里显示。（最喜欢的应用程序可以由用户添加/删除/更改其顺序。）
  - 应用程序：单击以跳转到应用程序屏幕，其中列出了所有已安装的应用程序。
- ③ 通知：显示通知。
  - 输入：用于选择输入源的图标。设置完成。
  - Network&Internet：Icon设置网络，如wifi。
  - 设置：可在此处配置各种设置。有关设置的详细信息，请参阅下一个说明。

# 电视机主体操作

## 输入源

1. 在HOME界面，按▲/▼/◀/▶键选择“输入”图标，按OK打开输入源列表，然后按向上高亮一个输入，按OK切换。

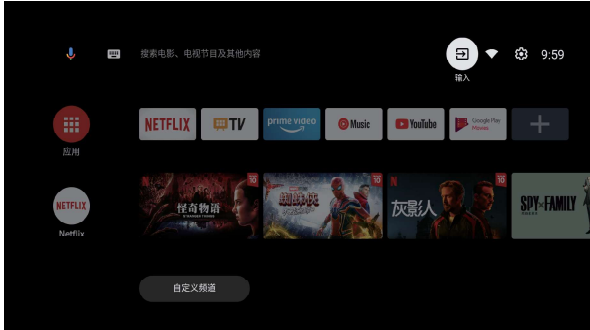

在直播电视下，按输入按钮以显示输入源列表。您可以选择不想要的来源。



## 浏览屏幕菜单

1. 有两种进入方式。首先，在直播中，按菜单键显示电视选项，按▲/▼/◀/▶选择设置菜单并按OK确认。其次，在HOME界面，按 键选择圆形设置菜单图标，按▶确定确认。

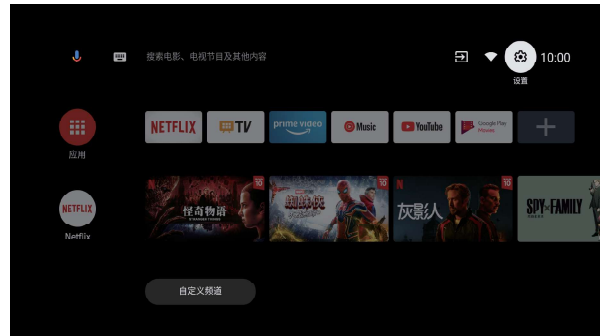
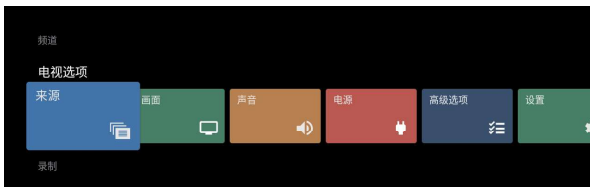

2. 按▲/▼按钮选择您要设置的内容。  
3. 按OK进入设置。

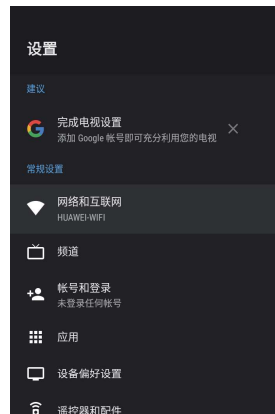

按返回键返回上一个菜单。如果显示主菜单，按返回键将关闭屏幕菜单。

## 网络和互联网

1. 按▲/▼按钮选择您要设置的内容。  
2. 按OK按钮进行调整。  
3. 调整完成后，按OK键保存并返回上一级菜单。



# 电视机主体操作

## 频道

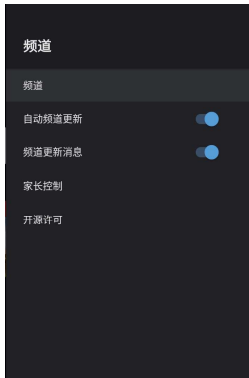

### 频道：

根据不同的通道安装模式显示扫描子菜单。



### 天线：

在 INPUT 界面选择天线频道，电视可以接收模拟和数字（DVB-T/DVB-T2）广播信号。

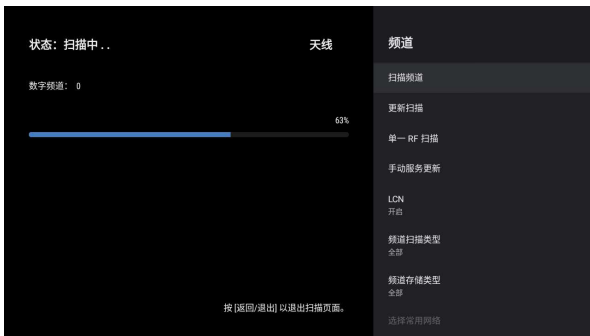

### 有线电视：

在 INPUT 界面选择有线频道，电视可以接收模拟和 QAM 广播信号。



## 账户&登录



按 ▲/▼ 键选择登录或跳过。

## 应用程序

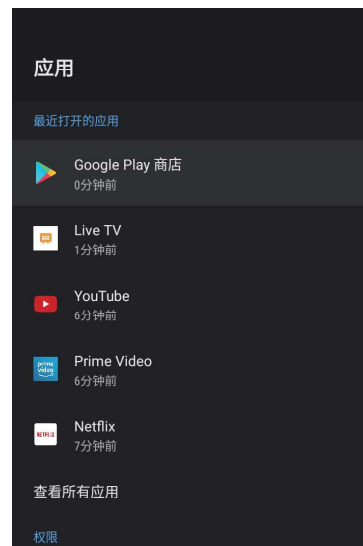

在此菜单中，您可以设置应用程序权限，读取应用列表。

1. 按 ▲/▼ 按钮选择您要设置的内容。
2. 按确定按钮进行调整。
3. 调整完成后，按BACK键返回上一级菜单。

# 电视机主体操作

## 日期&时间



**自动日期和时间** - 按 ▲/▼ 按钮选择选项，然后按 OK 按钮进入子菜单。  
(可选：使用网络提供的时间，关闭)

### 注意：

- 手动调整日期和时间设置将自动将自动日期和时间更改为关闭。
- 设置日期**：按 ▲/▼ 键选择选项，然后按 OK 键进入子菜单。  
**设置时间**：按 ▲/▼ 键选择选项，然后按 OK 键进入子菜单。  
**设置时区**：按 ▲/▼ 键选择选项，然后按 OK 键进入子菜单。  
**使用 24 小时格式**：按 ▲/▼ 按钮选择选项，然后按 OK 按钮选择 ON/OFF。

## 定时器



**开机定时器类型**：按 ▲/▼ 按钮选择选项，然后按 OK 按钮选择 ON/OFF/ONCE。

**自动开机时间**：按 ▲/▼ 键选择选项，然后按 OK 键进入子菜单。

**关机定时器类型**：按 ▲/▼ 按钮选择选项，然后按 OK 按钮选择 ON/OFF/ONCE。

**自动关机时间**：按 ▲/▼ 键选择选项，然后按 OK 键进入子菜单。

## 页面

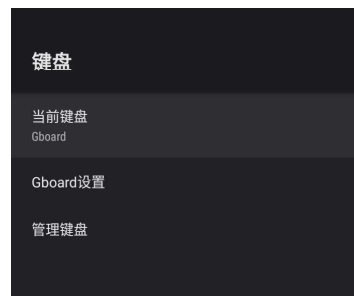

**当前页面**：按 ▲/▼ 键选择选项，然后按 OK 键进入子菜单。

**Gboard设置**：按 ▲/▼ 按钮选择选项，然后按 OK 按钮进入子菜单。

**管理页面**：按 ▲/▼ 按钮选择选项，然后按 OK 按钮进入子菜单。

## 输入



**输入**：按 ▲/▼ 按钮选择选项，然后按 OK 按钮进入子菜单。

# 电视机主体操作

连接 HDMI 设备后，单击主屏幕上的输入图标，您可以看到已连接设备的名称。  
切换到连接电视的HDMI输入，按遥控器上的 MENU 键，选择设置->设备偏好->输入，进入 CEC 功能参数。

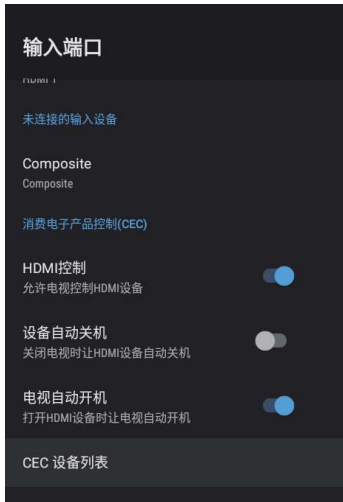

**消费电子控制 (CEC)**  
此功能允许通过电视机控制 HDMI 设备。

**HDMI控制**  
按 ▲/▼ 按钮选择选项，然后按 OK 按钮选择 ON/OFF。

**设备自动关机**  
启用此选项后，将在电视关闭时关闭 HDMI 源。  
按 ▲/▼ 选择选项，然后按 OK 按钮选择 ON/OFF。

**电视自动开机**  
启用此选项后，连接到电视的 HDMI 设备将与电视装置同时自动开启。  
按 ▲/▼ 按钮选择选项，然后按 OK 按钮选择 ON/OFF。

**CEC 设备列表**  
开启或关闭 CEC 功能的 HDMI 设备列表。  
按 ▲/▼ 键选择选项，然后按 OK 键进入子菜单。

## 功率



**睡眠定时器**：按 ▲/▼ 按钮选择选项，然后按 OK 键进入子菜单。（可选：off, 10 分钟、20 分钟、30 分钟、40 分钟、50 分钟、60 分钟、90 分钟、120 分钟）。

**图片关闭**：按 ▲/▼ 按钮选择选项，然后按 OK 按钮关闭电视。

**关闭定时器**：按 ▲/▼ 按钮选择选项然后按 OK 按钮进入子菜单。（可选：关闭、30 分钟、60 分钟、90 分钟、120 分钟、150 分钟、180 分钟、210 分钟、240 分钟）。

**无信号自动关机**：按 ▲/▼ 按钮选择选项，然后按 OK 按钮进入子菜单。（可选：关闭，5 分钟，10 分钟，15 分钟，30 分钟，60 分钟）。

**自动休眠**：无操作导致的自动待机功能。

## 画质



**图片模式**：按 ▲/▼ 按钮选择选项，然后按 OK 按钮进入子菜单。（可选：用户，标准，生动，运动，电影，游戏，节能）。

**背光/亮度/对比度/饱和度/HUE/锐度**：按 ▲/▼ 按钮选择选项。按 ◀ 键减小参数。按 ▶ 键增加参数。

**伽玛**：按 ▲/▼ 按钮选择选项，然后按 OK 按钮进入子菜单。（可选：暗、中、亮）。

**色温**：按 ▲/▼ 按钮选择选项，然后按确定按钮进入子菜单。

**高级视频**：按 ▲/▼ 按钮选择选项，然后按确定按钮进入子菜单。

# 电视机主体操作

## 音量控制

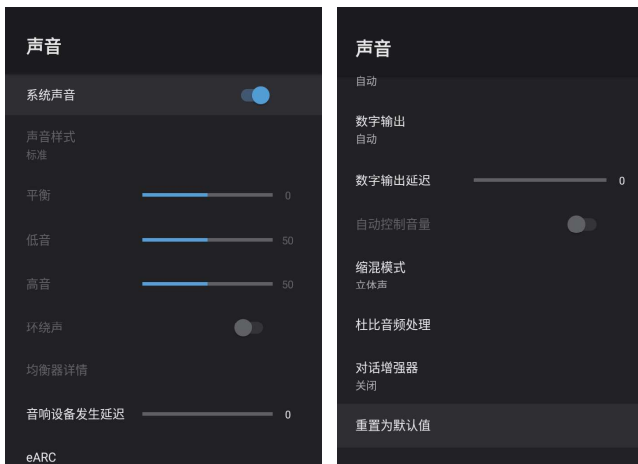

系统声音：按 OK 按钮选择 ON/OFF。

声音风格：按 ▲/▼ 按钮选择选项，然后按OK按钮进入子菜单。

（可选：用户、标准、生动、体育、电影、音乐、新闻）

天平：按 ▲/▼ 键选择该选项。按◀键减小参数。按▶键增加参数。

环绕声：按 ▲/▼ 按钮选择选项，然后按确定按钮选择开/关。

均衡器详情：按 ▲/▼ 按钮选择选项，然后按 OK 按钮进入子菜单。

数字输出：按 ▲/▼ 按钮选择选项，然后按OK按钮进入子菜单。（可选：Auto, Bypass, PCM, Dolby Digital Plus, Dolby Digital）

SPDIF 延迟：按 ▲/▼ 按钮选择选项。按 键减小参数。按增加源许可证的关键。

自动音量控制：按 ▲/▼ 按钮选择选项，然后按确定按钮选择开/关。

缩混模式：按/按钮选择选项，然后按OK按钮进入子菜单。（可选：立体声、环绕声）

重置为默认值：将所有设置重置为出厂默认值。

## 内存



内部共享存储：按 ▲/▼ 键选择选项，然后按OK键进入子菜单。

可移动存储：按 ▲/▼ 按钮选择选项，然后按OK按钮进入子菜单。（注：如果可用，显示外部设备）

## 主页面

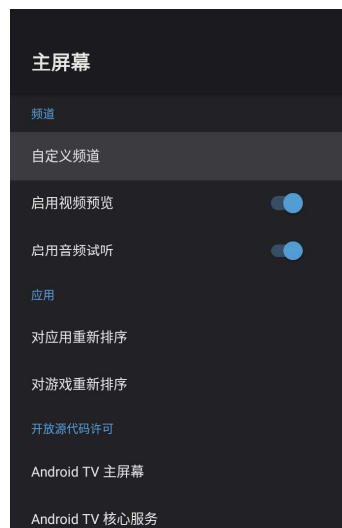

在此菜单中，您可以设置频道、应用程序、开源许可证。

1. 按 ▲/▼ 按钮选择您要设置的内容。
2. 按确定按钮进行调整。
3. 调整完成后，按BACK键返回上一级菜单。

## 演示模式

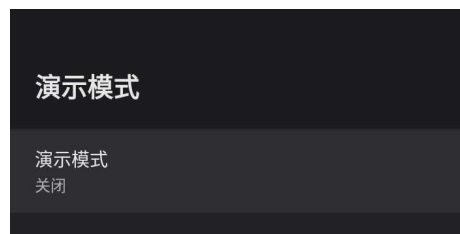

演示模式：按 ▲/▼ 键选择选项，然后按OK键选择ON/OFF。

# 电视机主体操作

## 谷歌助手

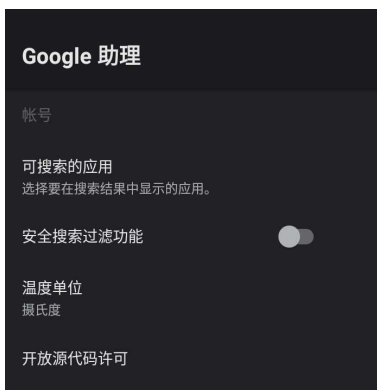

在此菜单中，您可以设置可搜索应用程序、安全搜索过滤器、阻止攻击性词语、开源许可证。

1. 按▲/▼按钮选择您要设置的内容。
2. 按确定按钮进行调整。
3. 调整完成后，按BACK键返回上一级菜单。

## 内置CHROMECAST



在此菜单中，您可以阅读 Chromecast 的信息和设置。

1. 按▲/▼按钮选择您要设置的内容。
2. 按确定按钮进行调整。
3. 调整完成后，按BACK键返回上一级菜单。

## 屏幕保护



屏幕保护程序：按▲/▼按钮选择选项，然后按确定按钮进入子菜单。（可选：关闭屏幕，背景，颜色）。  
何时开始：按▲/▼按钮选择选项，然后按OK按钮进入子菜单。（可选：5分钟，15分钟，30分钟，1小时，2小时）。

立即开始：按▲/▼按钮选择选项，然后按确定按钮进入屏幕保护程序。

## 定位

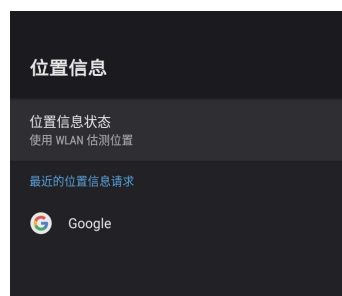

定位状态：按▲/▼键选择选项，然后按 OK 键进入子菜单。

（可选：使用 Wi-Fi 估计位置，关闭）

## 使用与诊断



使用和诊断：按▲/▼按钮选择选项，然后按确定按钮选择开/关。

## 可访问性

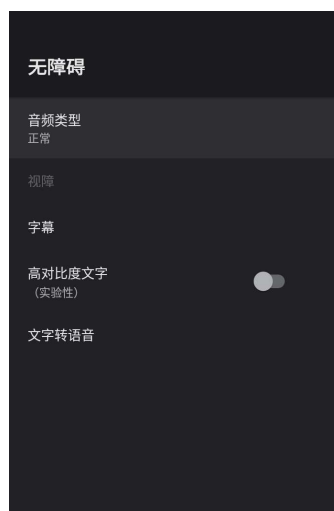



## 电视机主体操作

音频说明：按▲/▼按钮选择选项，然后按OK按钮选择ON/OFF。

视力障碍者：按▲/▼键选择选项，然后按OK键进入子菜单。（需要：音频描述开启）

字幕：按▲/▼按钮选择选项，然后按OK按钮进入子菜单。

高对比度文本：按▲/▼按钮选择选项，然后按OK按钮选择ON/OFF。

文字转语音：按▲/▼按钮选择选项，然后按OK按钮进入子菜单。

辅助功能快捷方式：按▲/▼按钮选择选项，然后按OK按钮进入子菜单。

TalkBack：按▲/▼按钮选择选项，然后按OK按钮进入子菜单。

### 重启

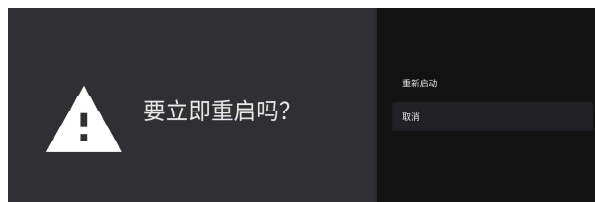

按OK按钮进入子菜单 点击“重启”重新启动电视

### 遥控器和配件



在此菜单中，您可以配对蓝牙设备。

1. 按住遥控器底部的“MENU”和“LEFT”键5秒。

2. 当LED开始闪烁时，松开它。

遥控器会向电视发送配对信号，并在屏幕右侧显示“BT\_VoiceRC\_20\_1”。



3. 按OK按钮显示配对。

如果显示paired，则连接成功。

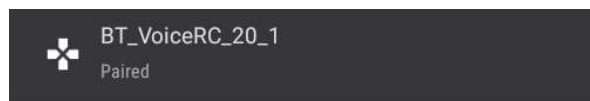

4. 如果出现can't pair，则连接失败。

等待30秒，然后按遥控器底部的“MENU”和“LEFT”按钮5秒，重复前面的步骤。

5. 按BACK按钮返回上一级菜单。

### 多媒体播放器

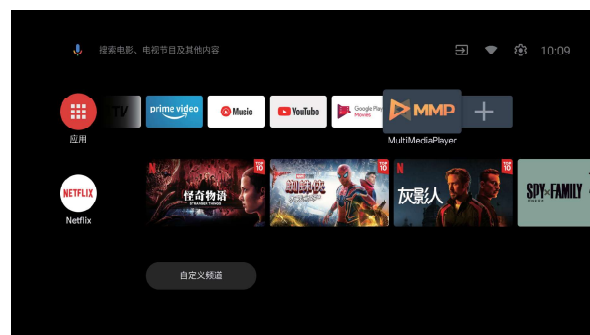

在HOME界面，选择MMP应用程序，显示视频、照片、音频、文本。插入U盘后，即可查看U盘中对应的文件。

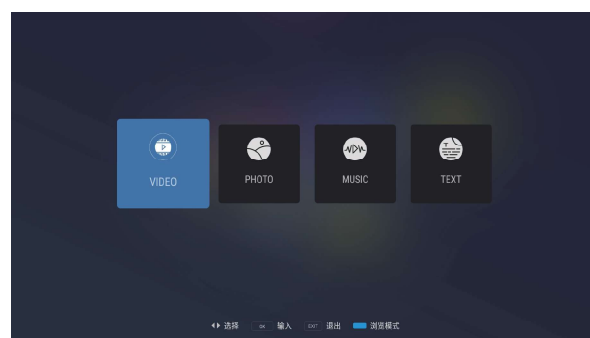

### 注意：

菜单可能会与您购买的电视机有所不同。

## 疑问解答

如果您有任何问题，请检查下列每种故障的应对措施。  
以下故障可能是由于调整不当而不是本机实际故障引起的。如果问题仍然存在，请联系客户服务中心，联系方式见背面。

故障	解决方案
不能开机	请检查已插入的电源线以及电源插座是否正常工作。 拔下电源线并在 60 秒后插入，然后重新启动电视。
没有图像	请检查天线是否调节好。 请检查电视机附近是否有其他电子设备的干扰。 请调整对比度和亮度的设置。
图像清晰但没有声音	请提高音量。 请检查电视是否处于静音模式，按遥控器上的静音按钮。 请检查声音设置。 如果正在使用外部设备，请检查它们的音量是否设置得太低或关闭。 如果使用 AV 输入，请确保电缆连接正确且没有松动。
图像没有颜色或声音	请检查天线连接和天线状况。 如果使用 AV 输入，请检查 AV 连接，错误或松动的连接可能会导致颜色问题或导致屏幕空白。
遥控器操作失灵	遥控器电池正负极是否安装正确？ 遥控去电池是否电量低？ 尝试关闭电视机并重新启动。 尝试遥控器重新对码。
屏幕上出现彩色圆点	电视机屏幕上存在微小的红色、蓝色、绿色斑点·（亮点），或某些画面下出现暗色的斑点（暗点）并非故障。由于液晶面板需要非常精密的生产技术，可能产生极少数常亮或常暗的像素，不会影响电视机的整体性能。
图像不清晰	使电视远离嘈杂的电源，例如汽车、吹风机、焊机和所有可选设备。 电气大气干扰，例如局部或远处的雷暴，可能会导致画面破裂。 安装选购设备时，请在选购设备和电视机之间留出一些空间。 检查天线和连接。 使天线远离任何电源或输入/输出电缆。
自动调谐后只有部分频道可用	检查您的区域是否被数字视频广播覆盖。 尝试重新调谐或手动调谐丢失的频道。 检查您是否使用了正确的天线类型 - 请参阅第 16 页“天线连接”。

## 疑问解答

无法选择电视频道	检查频道是否在主菜单设置中被封锁。
USB无法连接	请检查连接 USB 电缆并连接电源。硬盘驱动器尚未格式化。请确保 USB 磁盘兼容并且支持多媒体数据格式。
图片失真、出现宏块、小块、黑点、像素化等	视频内容的压缩可能会导致失真，尤其是在运动和动作电影等快速移动的画面。
喇叭出现噪音	检查电缆连接，确保视频电缆未连接到音频输入。低信号电平可能会导致声音失真。
电视自动开机	检查“设置”菜单中的“开启定时器”是否设置为“开启”。
图片未全屏显示	显示 SD(4:3) 内容时，每侧的黑条将显示在高清频道上。纵横比与电视不同的电影将显示顶部和底部的黑条。将外部设备或电视上的图片大小选项调整为全屏。

**SHARP**  
SHARP CORPORATION



4031Q55B026